



Annex I
of MedDream USER MANUAL (version 8.3.1)

MedDream viewing functionalities
version 8.3.1

The annex describes the usage and configuration of MedDream Viewing functionalities.

See the MedDream USER MANUAL document for the general information about the MedDream product, installation requirements and verification, IT security measures.

© 2023, Softneta UAB, Kaunas

All rights reserved in the event of granting of patents or registration as a utility patent.

All names of companies and products mentioned in this user`s manual may be trademarks or registered trademarks. References to products of other manufacturers are for information purposes only. Such references are intended neither as an approval nor a recommendation of these products. Softneta UAB accepts no liability for the performance or use of such products.

Other brand names, software and hardware names used in this user`s manual is subject to trademark or patent protection. The quoting of products is for informational purposes only and does not represent a trademark misuse.

This user`s manual is protected by copyright. Unless exclusively authorized in writing, dissemination, duplication or other commercial exploitation of this documentation set or communication of its contents or parts of it is not permitted. In case of infringement, the violator may be liable to pay compensation for damages.

Specifications due to technical developments are subject to change. This user`s manual is not subject to the revision service. Please contact the manufacturer or authorized dealer to request the latest edition of the manual.

Table of Contents

Table of Contents.....	3
MedDream viewing functionalities.....	7
Minimum hardware requirements for client-side MedDream viewing functions	7
Logging on to MedDream	8
Displaying notifications	9
Search of studies.....	10
MedDream DICOM Viewer.....	16
Viewer window	16
Toolbar	17
System tools.....	18
Thumbnails bar.....	18
View zone.....	22
Viewport toolbar.....	24
Copy viewport content	26
Copy original image to the clipboard.....	27
Quick access to additional data	27
Color palette for monochrome images.....	28
Quick menu.....	29
Opening studies	31
Patient studies window	32
Patient history	33
Tools for image manipulation and analysis	36
Windowing.....	36
Histogram.....	38
Pan.....	40
Zoom.....	42
Channels	43
Scroll	44
Magnifier.....	44
Digital Subtraction	45
Montage	46
Sync actions.....	47
Layout and Multi image/series.....	49
Split layout.....	52
Reset.....	53
MPR	54
Axial, Coronal, or Sagittal	54
Orthogonal	55
MIST Oblique.....	56

MIST Axial, MIST Coronal, MIST Sagittal	68
Reference Line and Crosshair	69
Rotate	71
DICOM	72
Link scrolled series	73
Tools for measuring, and annotation saving	76
Measuring images	76
Line	78
Angle	79
Cobb Angle	79
Polyline	80
Area	80
Ellipse and Rectangle	81
Volume	83
Height Difference	88
Velocity Time Integral (VTI)	89
Tibial Plateau Angle	89
Norberg Angle	90
Verbal Heart Scale	91
Hip distraction index	93
Tibial tuberosity advancement	94
Cardiothoracic ratio	95
Flatfoot	97
Goniometry	98
TT-TG Distance	100
Vertebra angle	103
Spine Labeling	103
Region Of Interest	111
Closed polygon and Repulsor	111
Flexpoly	112
Pencil	113
Arrow	113
Text annotations	114
Time-Intensity Curve	115
Continuous measurement	118
Intensity	118
Show Angles	119
Ruler	119
Calibration line	120
Delete measurements	120
Save Annotation	121
Copy and paste measurement	121

Copy and paste ellipse.....	123
Copy measurement values to clipboard	123
Annotations	124
Key Objects	127
Key Objects with annotation	130
Segmentation	131
Bounding Box	132
Smart Paint	137
Common actions of segmentations.....	155
Shortcuts, Close Window.....	164
Tools for study exchange.....	166
Share files via DICOM Library	166
Forward	167
Export.....	168
LiveShare	168
Fusion function.....	171
Manipulating fusion series	172
Cine mode.....	175
Other Viewer tools	176
Series	176
Plugins.....	177
Full Screen	177
Theme	177
Thumbnails.....	177
Preload Series.....	178
Print.....	178
Hanging protocols	179
Report.....	181
Info Labels.....	181
4D Tools	182
Construct 4D series	182
Show 4D slider bar	183
Presenter tool.....	184
Special views	185
ECG module.....	185
SR view	189
PDF view	190
Video view.....	190
Multi-frame view	191
Overlay layer	192
MedDream DICOM Viewer Chrome browser extension for multi-monitors	193
Size and position of window.....	198

Modal dialog	198
Non-modal windows	199
Export and Forward	200
Forward window	200
Export / Burn to CD/DVD window	203
Recent Export Jobs window	206
Report module	208
Managing report templates	213
System menu functions	216
About	216
License Agreement	217
Help	218
Shortcuts	218
Clear cache	220
Settings	220
Log Off	221
License registration	222
Settings	224
General settings	225
Search window settings	225
Viewer window settings	226
Measurements settings	229
Label Properties	229
Presenter Settings	232
Toolbar Properties	233
Windowing settings	235
Report settings	237
Hanging protocol settings	238
MedDream Mobile mode	244
Search of studies in mobile mode	244
Viewer window in mobile mode	247
Opening studies in MedDream Mobile mode	250
Patient studies list in mobile mode	253
Manipulating images in MedDream Mobile mode	254
Setting window in mobile mode	257
Table of Figures	261
Index	272

MedDream viewing functionalities

The annex describes the usage and configuration of MedDream Viewing functionalities.

See the MedDream USER MANUAL document (<https://www.softneta.com/files/meddreamviewer/doc/MedDream-User-Manual.pdf>) for more information about MedDream product:

- general information about the MedDream product,
- list of applicable standards,
- warnings regarding residual risks,
- installation requirements and verification,
- IT security measures .

Minimum hardware requirements for client-side MedDream viewing functions

The table describes the requirements for computer, that uses MedDream viewing functionalities from remote MedDream server through the internet:

Parameter	Minimal Requirements
Desktop Web	
CPU	Intel® Core™ i3 4 core CPU or better
RAM*	8+ GB, 256+ MB of video memory
Storage space	10+ GB
Network Bandwidth	100+ Mbit/s
Web Browsers	Chrome 120+, Firefox 120+, Microsoft Edge 120+, Safari 17+
Mobile device iOS Web	
RAM*	2+ GB
Storage space	2+ GB
Network Bandwidth	100+ Mbit/s
Web Browsers	Safari 17+, Chrome 120+
Mobile device Android Web	
RAM*	2+ GB
Storage space	2+ GB
Network Bandwidth	100+ Mbit/s
Web Browsers	Chrome 120+, Firefox 120+

* For CT, MRI, PET-CT client side MPR/MIP rendering:

- 64bit CPU and 64bit operating system;
- Graphic board with ≥ 1 GB video memory (hardware acceleration is enabled on the browser);
- 12 GB of RAM to open more than 800 images;
- 16 GB of RAM to open more than 1500 images;
- 24 GB of RAM to open more than 3000 images (cardiac or functional imaging, MG Tomosynthesis).

* For MG Mammography:

- 64bit CPU and 64bit operating system;
- Graphic board with ≥ 1 GB video memory (hardware acceleration is enabled on the browser);
- 16 GB of RAM.

* For MG Tomosynthesis:

- 64bit CPU and 64bit operating system;
- Graphic board with ≥ 1 GB video memory (hardware acceleration is enabled on the browser);
- 16 GB of RAM.

* Depending on the total amount of RAM on user's workstation, the browser is allowed to allocate the restricted amount of memory, and therefore MedDream application may load not more than 16 GBytes of data. Due to these limitations, browser may run out of memory, if the user loads several large computed tomography, mammography or tomosynthesis studies.

 **NOTE!** Hardware acceleration should be enabled in web browser for better performance.

 **NOTE!** Mozilla Firefox browser has certain memory limitations: MIST MPR functionality will fail on series where uncompressed DICOM data is larger than 2 GB.

 **NOTE!** MedDream enables users to view all data stored with a bit depth of up to 16 bits per color channel. However, it displays 8 bits per color channel at a time due to web browser limitations (maximum display of 256 values per color channel). You can utilize the Window leveling tool to explore the entire data range within the images.

 **NOTE!** The MedDream viewing functionalities server system requirements are detailed in the Install Manual of the MedDream viewing functionalities.

Logging on to MedDream

 **NOTE!** If integrated Viewer is used, the login window may be disabled in configuration.

To log on to MedDream, please do the following:

Enter the address given by your administrator in your Internet Browser. The following screen will appear:

- Enter the username you were given in the field Username.
- Enter the password in the field Password. If you forgot your password, please contact your system administrator.
- Press Log in button.

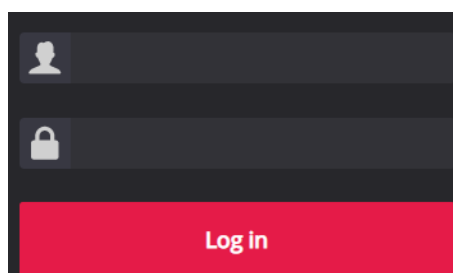



Figure 1. Log in window

 **NOTE!** Login may be blocked in case of several failed login attempts, if restrictions are configured.

 **NOTE!** Contact your system administrator, if you can not access the login page from outside the regular workplace. Access to login page only from a particular IP range or host name may be configured.

NOTE! Search window should be displayed after successful login. If the error about forbidden functionality is displayed instead, press the Log Off button, in case it is displayed on the error page, and contact your system administrator to verify the system configuration and user rights.

NOTE! On the right upper corner of the login window you can change the language by selecting the language code from drop-down list.

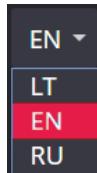



Figure 2. Language selection in a log in window

NOTE! The list of supported language is defined in configuration.

NOTE! The language selection is saved in browser local storage.

Displaying notifications

The **Notification** menu  is displayed in the system menu area of Viewer, Search and Settings window.

The messages that are issued by the system in the currently viewed window are temporary displayed in the top right corner of the window, and may later be access through notification menu:

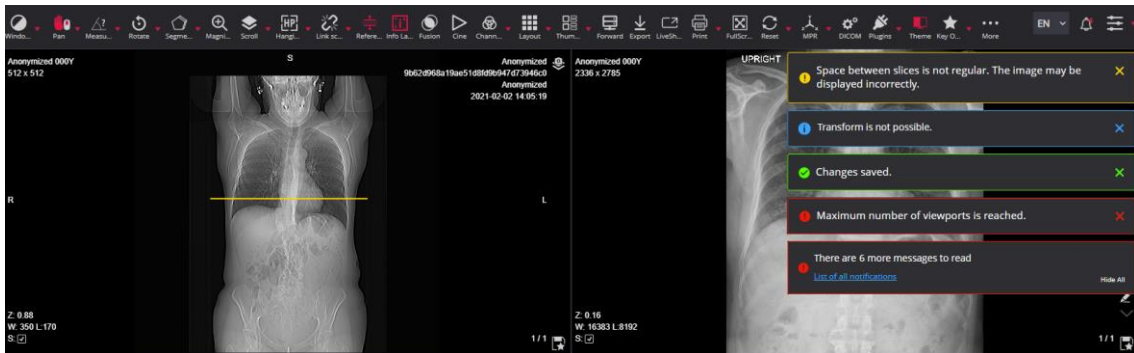







Figure 3. Notifications temporary displayed in the viewer window

If the current notifications list contains errors, the number of error messages is displayed at the top right corner of the icon: .

NOTE! Viewer, Search and Settings windows has separate notifications lists.

Rules for displaying notifications in the window:

- Each message has a severity sign at the left side of the notification window, as described below in the order of increasing severity:
 -  success message indicates, that action was successfully performed,
 -  info message notifies the user about system possibilities or system actions,
 -  warning message notifies that user should be more cautious and possibly take additional actions to prevent any damage,
 -  error message informs that something went not as expected;
- Notifications in the window are displayed temporary. The system automatically hides the message window after 5 seconds. Each notification has the close button at the right side, and can also be closed by the user.
- Up to four notifications may be displayed at a time in the window, with the earliest messages displayed at the top of the list. If there was more than four messages popped, the system displays the summary message:
 - the summary message shows the number and the highest severity sign of not displayed notifications,
 - the messages from the summary notification will automatically be displayed one by one, as the notifications in the window is closed by the system or user,
 - the user can remove all the displayed and still not displayed messages from the window by clicking the **Hide All** link in summary message window.

Notifications window may be opened by either clicking the **List of all notifications** link in summary notifications window, or Notifications icon in toolbar. The **Notifications** window lists all the messages that were hidden from the window, and were not cleared from the notifications list:

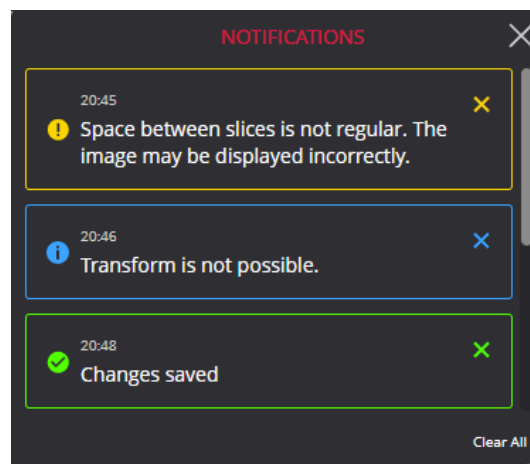

Figure 4. Notifications window

Besides the above-described message content, the time, when message was issued, is displayed.



NOTE! Pressing **Close** button for the message displayed in **Notification** window, deletes this message from the notifications list. Pressing **Clear All** link deletes all the messages at once.

Search of studies

The Search menu will help you quickly find the studies you need. We recommend using all possible search menu options in order to get the most accurate search results and save your time. Search parameters are accessible from Search window that is opened after the successful login.

ID	Accession	Modality	Description	Date Time	Received On	Source AE
0 STOWRS-10.2.29.30-20190805100743	Anonymized	OT	EXTERNAL RECORD - X-RAY	2021-11-29 12:09:03	2022-09-23 10:14:52	SENDTOPACS
0	Anonymized 5937a1	OT	SendToPACS DEMO	2021-12-13 13:57:44	2022-01-24 09:54:04	SENDTOPACS
New test[MEDDREAM-0531151117]	Anonymized	KD, MR, OT, PR, RTSTRUCT	HEAD*ROUTINE	2022-02-02 08:07:23	2022-02-03 15:54:26	MEDDREAM
0 STOWRS-10.2.29.30-20190805100743	Anonymized	ECG	ECG from EDF+	2022-02-03 09:40:32	2022-04-01 10:17:01	SENDTOPACS
0 STOWRS-10.2.29.30-20190805100743	Anonymized	MR	IRM PROSTATE	2022-03-01 14:17:45	2022-04-05 15:33:21	SENDTOPACS
0 STOWRS-10.2.29.30-20190805100743	Anonymized	CT, KD, PR, RTSTRUCT, SR	PILVAS	2022-03-07 10:47:48	2022-04-06 16:27:32	MEDDREAM
0 STOWRS-10.2.29.30-20190805100743	Anonymized	KD, MR, PR	BRAIN STROKE PROTO.	2022-03-21 14:27:50	2022-03-21 15:24:37	MEDDREAM
0	Anonymized	KD, MR, OT, PR	BRAIN STROKE PROTO.	2022-03-21 14:27:50.200000		
0 STOWRS-10.2.29.30-20190805100743	Anonymized	KD, MR, OT, PR	BRAIN STROKE PROTO.	2022-03-21 14:27:50.200000		
0 STOWRS-10.2.29.30-20190805100743	Anonymized	KD, MG, PR		2022-03-30 09:20:20	2022-04-14 15:23:29	MEDDREAM

Figure 5. Search window

NOTE! If integrated Viewer is used, the search window may be disabled in configuration.

NOTE! If the error about forbidden functionality is displayed after login, press the Log Off button, in case it is displayed on the error page, and contact your system administrator to verify the system configuration and user rights.

Description of search menu parameters:

1. Search for studies according the search criteria listed below can be done by selecting the criteria entry field and entering the text in it:

- **ID** - enter patient's ID number
- **Name** - enter the patient's name or surname
- **Accession** – enter the study accession number
- **Modality** - enter the method which was used to obtain the study images
- **Description** – enter a few keywords from the study description
- **Source AE** – enter title of the device from where the study was sent to the PACS.

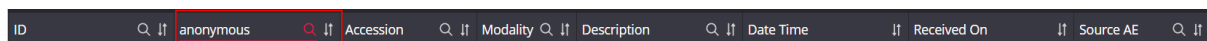

Figure 6. Search criteria entry fields in search window

NOTE! It is not possible to search for Ideographic and Phonetic versions of patient names. The search is performed only against the basic version (Alphabetic), even if the image contains the other two versions and the PACS supports them.

NOTE! Search criteria entry field is marked with a loupe sign at the right. The loupe sign is highlighted when the field is selected, or the search criteria is applied.

NOTE! To perform the search, press **Enter** key after the criteria is entered.

2. Search for studies having the study date in the specified date interval can be done. There are two ways for defining the date interval:

- To select the **date interval** from the quick pick list: “**1d**” (current day), “**3d**” (3 days interval), “**1w**” (1 week interval), “**1m**” (1 month interval), “**1y**” (1 year interval) or “**Any**” (no specific date interval):

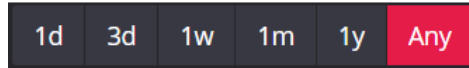

Figure 7. Quick pick list for choosing the study date interval

NOTE! One date interval value can be picked at a time. The ends of picked interval are displayed in the date fields on the left of the interval pick list. The fields are empty if no specific interval (**Any**) is picked.

NOTE! The default **date interval** is defined in “Settings”. The search according the picked date interval is performed automatically on search window open and on any interval change in pick list.

- To specify one or both ends of the **date interval** in the date fields on the left of the interval pick list: click on the interval start or end entry field and choose the date from the pop-up window.

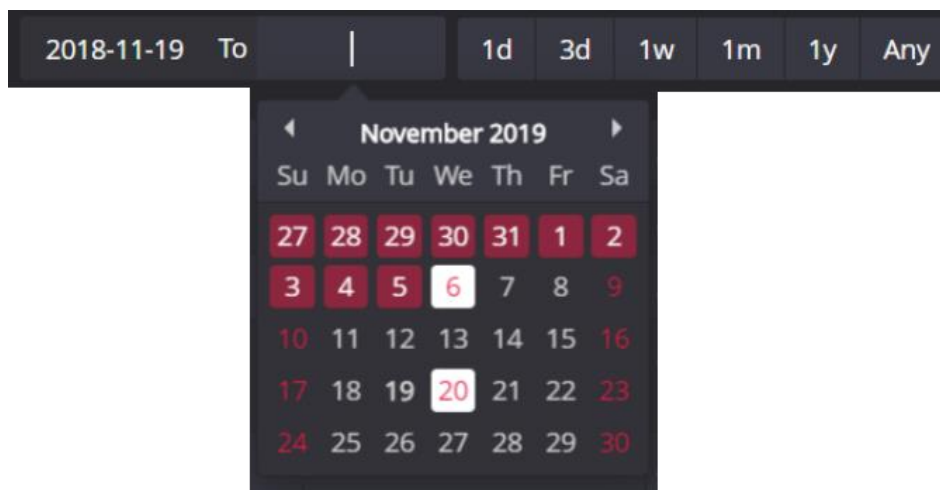

Figure 8. Study date interval entry fields

NOTE! To perform the search according the entered date interval click **Search** icon after the interval ends are entered.

3. The search can also be done by the method which was used to obtain the study images (modalities). You can pick one or more modalities from the modalities that are visible in modalities pick list:



Figure 9. Pick list for choosing modality: CT is chosen

NOTE! The search according the picked **modalities** is performed automatically on any change in pick list.

WARNING! The picked modalities are saved in browsers local storage and search according these modalities is automatically performed on search window open next time.

You can customize the modalities pick list: expand the modalities list with triangle on the right side of the list and pick the modalities that you want to appear in modalities pick list.

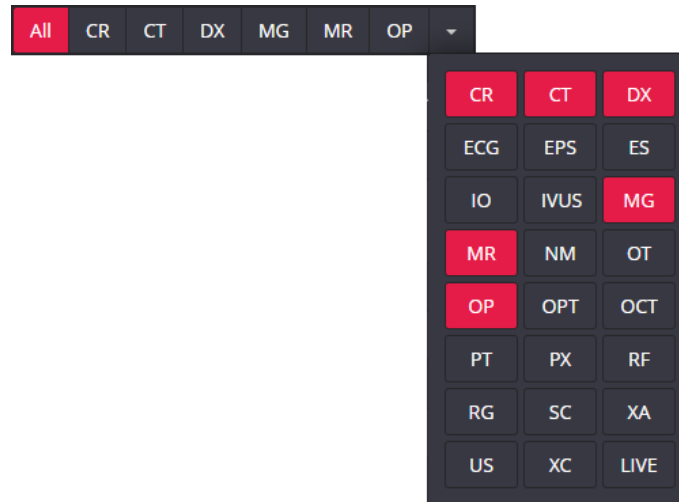

Figure 10. Customization of modalities pick list

The list of modalities:

CR – Computed Radiography

CT – Computed Tomography

DX – Digital Radiography

ECG – Electrocardiography

EPS – Cardiac Electrophysiology

ES – Endoscopy

IO – Intra-Oral Radiography

IVUS – Intravascular Ultrasound

MG – Mammography

MR – Magnetic Resonance

NM – Nuclear Medicine

OT – Other

OP – Ophthalmic Photography

OPT – Ophthalmic Tomography

OCT – Optical Coherence Tomography (non-Ophthalmic)

PT – Positron emission tomography (PET)

PX – Panoramic X-Ray

RF – Radio Fluoroscopy

RG – Radiographic Imaging

SC – Secondary Capture

XA – X-Ray Angiography

US – Ultra Sound

XC – External camera photography

LIVE – live stream

NOTE! If you are searching for some rare modality that has no corresponding button here, try to enter its abbreviation directly into the search criteria **Modality**. The system searches for all the modalities that are picked in modalities control and entered in Modality search criteria.

NOTE! The primary list of modalities that are displayed in modalities selection control is defined in “Settings”. The customized modalities list is saved in browser local storage after the customization is done.

4. The search for study in particular storage can be done. You can pick a particular storage from drop-down storage list:

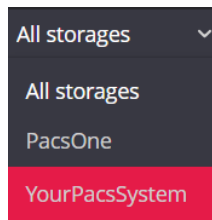

Figure 11. Picking the storage

The search according the picked **storage** is performed automatically on selection change.

NOTE! The storage selection control is visible only if multiple storages are configured.

NOTE! The storage selection is saved in browsers local storage and search in this storage is automatically performed on search window open next time.

CAUTION! Be aware, that access to the storages may be restricted by the user rights. The storages list contains only the storages, that are granted for the user. Searching is performed only in the granted storages, if the **All storages** option is selected.

5. The search for reported or not reported studies be done. By default, the system searches all, reported and not reported, studies. You can pick a particular option from drop-down list:

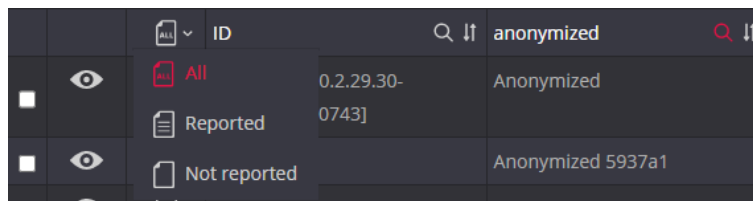

Figure 12. Picking the reporting criteria



The search according the picked criteria is performed automatically on selection change.

After the search is performed, the studies, that correspond to the search parameters, are displayed in search results list. The results list displays the following study information:

- **ID** - patient's ID number.
- **Name** - patient's name and surname.
- **Accession** – study accession number.
- **Modality** - method which was used to obtain the study images.
- **Description** –study description.
- **Date Time** – study date and time.
- **Received On** – the date and time when the study was received by PACS.
- **Source AE** – title of the device from where the study was sent to the PACS.

NOTE! The field is empty if the DICOM file or PACS does not have the particular data.

In the search results list, you can do the following:

1. To sort the result list by any of data fields. Each field has **Ascending/Descending** button . You can arrange each of them in ascending  or descending  order. Click once and the order of the selected field will change from ascending to descending and vice versa.

2. To navigate through result list by picking the required page or using **Previous** and **Next** in page navigation controls:

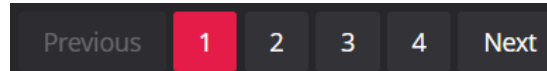

Figure 13. Page navigation in the search results list



NOTE! The number of studies per page is defined in [Settings](#). If the search results of the page do not fit to the window, you can scroll the list with the scrollbar at the right side of the results table, or with the mouse wheel while hovering over results list.

3. To mark the studies for forward or export by checking the tick box in first column of the results list:

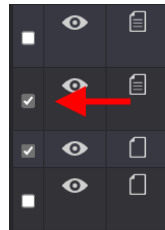



Figure 14. Marking the study

The forward and export functionality is activated by selecting the appropriate menu in the search window. See detailed description in section “Export and Forward”.



NOTE! The Tick box selection status is reset to unselected on Search window reload, for example when the sort order is changed, the page is refreshed, the user navigates to the other page.

4. To open the study in viewer by clicking the study in the search results list. See detailed description in section “Opening studies”.

5. To open the Report window by clicking the Create report  icon, or Edit report  icon in the search results list. See detailed description in section “Report module”.

You can do the following using the buttons in the top right corner of the search window:

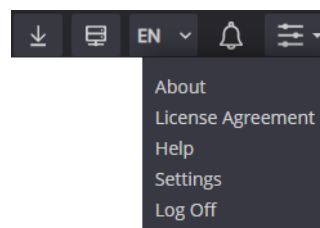

Figure 15. The other menu in Search window

1. Clicking the **Export** button opens the export window. Before doing so, mark the studies you want to export. See detailed description in section “Export and Forward”.
2. Clicking the **Forward** button opens the forward window. Before doing so, mark the studies you want to forward. See detailed description in section “Export and Forward”.
3. **Language** menu enables language change by picking language code in expandable list.
4. Clicking **Notifications** button opens the notification window. The notifications functionality is explained in the section “Displaying notifications”.
5. **System** menu in Search window contains the following options: About; License Agreement; Help; Setting; Log Off. See detailed description in section “System menu functions”.

⚠ CAUTION! Export, and Forward functionality may be disabled. Contact the system administrator to verify the configuration, if export or forward is missing.

MedDream DICOM Viewer

Viewer window

Viewing and analyzing the study images is done in Viewer window. Viewer window contains several zones.

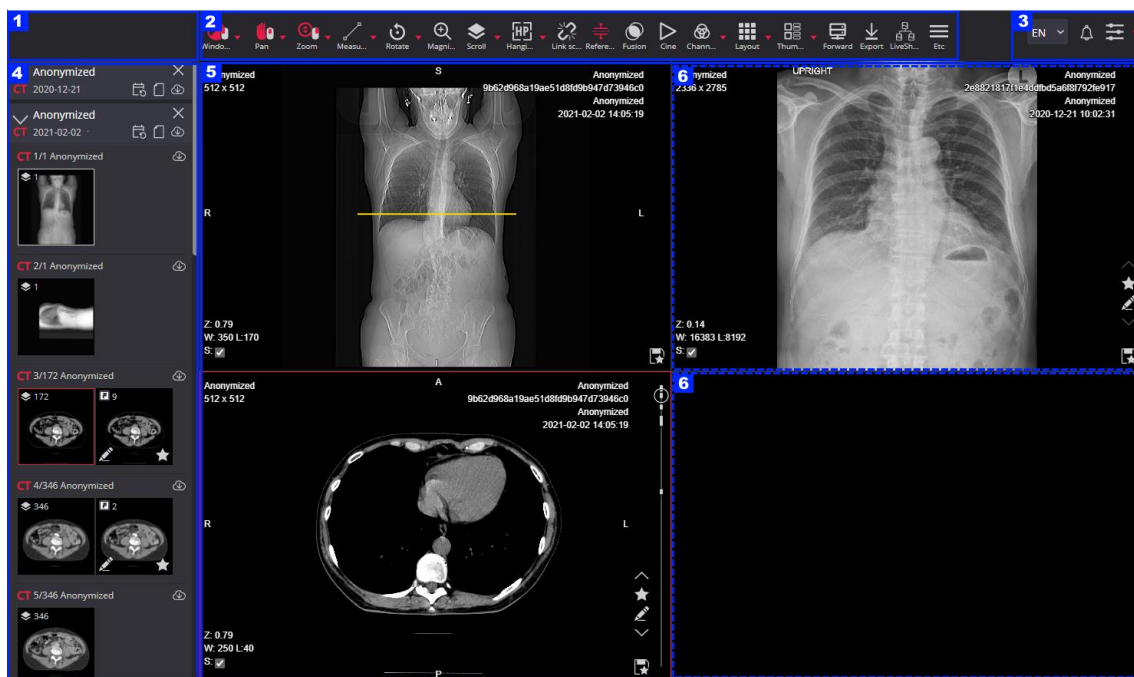

Figure 16. Viewer window zones

The Viewer window zones, with blue border and number in the top left corner, as displayed in the figure above:

- Zone 1 in the left corner of the Viewer window header row displays system logo;
- Zone 2 on the right of the system logo in the Viewer window header row displays toolbar with image manipulation tools;
- Zone 3 in the right corner of the Viewer window header row displays the system tools;
- Zone 4 displays the thumbnails. Thumbnails zone is displayed on the left side of the window in the figure, but may be displayed in another place as well (see description in section “Thumbnails”);

NOTE! By default, system is configured to not show the image thumbnails for CT, MR, PT and NM series, and also the for the multiframe that is displayed as series of images, in order to decrease the study loading time. The system administrator should change the configuration, if all thumbnails are needed for these series, as displayed in picture.

- The view zone 5 takes the largest part of the Viewer window in the figure, and may be divided to several viewports (zone 6 with dashed line border in figure).

The description of Viewer window zones follows in the subsection of this section.

Toolbar

Image manipulation tools are displayed at the top of the Viewer window. In section “Toolbar Properties” you can configure what buttons and in what order are shown on toolbar. If there is not enough space for the buttons to be displayed, the **More** button is displayed at the end of the toolbar. Click the **More** button to see the missing tool buttons.

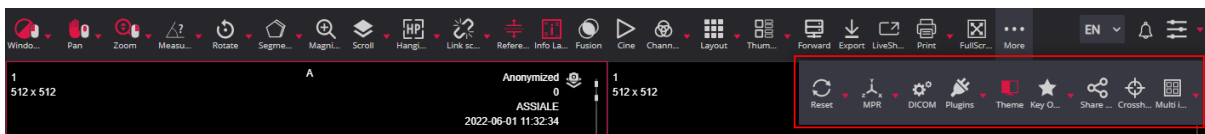
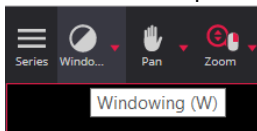



Figure 17. Expanded toolbar.

NOTE! The tools displayed on the toolbar depend on the image being uploaded in the active viewport.

In the toolbar you can also enable mouse usage for a particular tool. To enable the mouse usage for a tool, perform the following:

- Hover the mouse pointer over the tool icon: in the example, the cursor is over the Windowing icon





- Press the mouse key that you want to use for the mouse action
- Tool icon displays the activated mouse button: in example , the left mouse button is activated to change the brightness level.

NOTE! The mouse button assignment is saved in browser’s local storage. If local storage does not contain the saved values, the default assignment is used: left mouse button is assigned to **Windowing** tool, middle mouse button is assigned to **Pan** tool, and right mouse button is assigned for **Zoom** tool.

The active mouse key is deleted by pressing the same key over the tool icon once more or by activating the same mouse key for another tool.

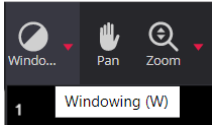
You can activate and deactivate the left mouse button usage for tools' mouse action with keyboard: press the

letter displayed in tooltip . Pressing 'W' activates the left mouse button usage for windowing function .

Clicking the triangle on the right of tool icon expands the tool menu:

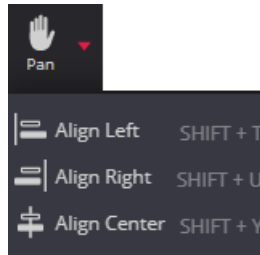

You can activate the menu option by clicking it. If the option has an assigned shortcut, the key combination is written on the right: for example, pressing 'SHIFT' and 'T' keys simultaneously, aligns the active image left.

 **NOTE!** When installing a new version of the system, the Toolbar order is changed by default. It is possible to specify that the current order is kept and that new menus are added to the end of the Toolbar. See the installation instructions for details.

System tools

The system tools zone contains three buttons:

- **Language** menu that enables language change by selecting the language in expandable list.
- Expandable **System** menu with the following options: About; License Agreement; Help; Shortcuts; Settings; Log Off. See detailed description in section "System menu functions".

 **NOTE!** System menu options may be disabled in "Settings". The Settings option may also be not allowed by user rights.

 **NOTE!** Log Off functionality in Viewer window is available only for integrated viewer with disabled Search window. If the Log Off is not available in Viewer window, use Log Off in Search window.

- **Notifications** menu opens the notification window. The notifications functionality is explained in the section "Displaying notifications".

Thumbnails bar

The Thumbnail holds the studies that are opened in Viewer window. By default, the patient's name, study modality and study date are displayed in the study description section of the thumbnail. The additional label and date highlighting for comparison studies may be configured in system settings:

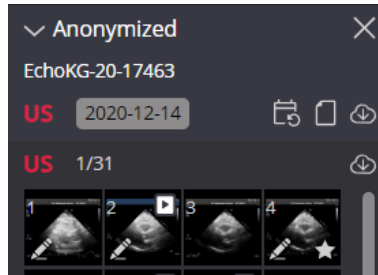





Figure 18. Study description section with additional label and highlighted comparison study date

If study description is expanded, the series description and series images thumbnails are displayed.





NOTE! By default the series are listed in the same order as returned from the storage, but moving the series of the particular modalities to the end of the series list may be configured. Contact your system administrator for changing the default system configuration.

For video and multi-frame images, the type indicator  is displayed at the top right thumbnail's corner. The Annotation icon  is displayed at the bottom left thumbnail's corner, if presentation state is saved for the image. The Key object icon  is displayed at the bottom right thumbnail's corner, if the image is marked as key object.

In order to decrease the study loading time, the system may be configured to not show all the image thumbnails for the series with large number of images:

- The series of CT, PT, and MR modality, that in general has large number of images;
- The series of MG, OPT, and NM modality, that are created from primary multi-frame image.

In such cases only one series thumbnail image is displayed, and thumbnail is generated from the first or middle image in the series.

If a series has images annotated or marked as key objects, icons with the quantities of these objects are shown next to the series thumbnail:  - saved key objects,  - unsaved key objects,  - annotations. If a segment has been created in the series, the segmentation icon appears . The segmentation icon can be highlighted  if a segmentation is selected in the action window (see the Segmentation section for details).

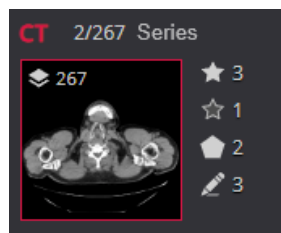

Figure 19. Study description section with additional label and highlighted comparison study date

NOTE! By default, system is configured to not show the image thumbnails for CT, MR, PT and NM series, and also the for the multiframe that is displayed as series of images.

NOTE! By default, series thumbnail is generated from the first image in series.

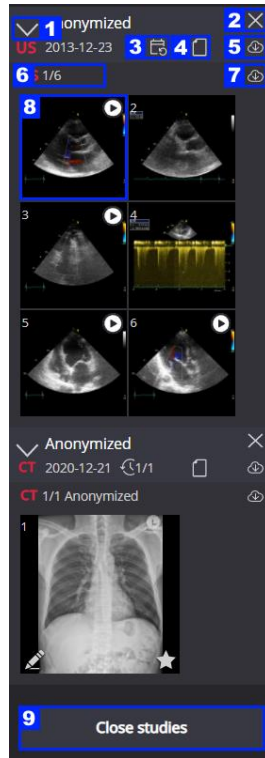







Figure 20. Action controls in Thumbnail

In thumbnail zone you can perform the following (see control numbers in Figure 20 and Figure 22):

- Expand or collapse the study description by clicking the chevron icon (number 1) at the top left corner of the study description.
- Remove the study from Viewer window if you are done with it. To remove the study from Viewer window, click on close study button (number 2) at the top right corner of the study description.
- Open patients' studies modal (see detail description in section "Patient history") by clicking the patient's history icon  (number 3) in the study description.
- Open Report window by clicking the Create report  icon, or Edit report  icon (number 4) in study description. See detail description in section "Report module".
- Preload the data by clicking the preload icon . Clicking the preload icon on the right side of study description (number 5), preloads the whole study. Clicking the preload icon on the right side of series description (number 7), preloads the series. Study or series preload allows to scroll through the images much faster.

 **NOTE!** Automatic start of the study instances preload on study opening, or progressive instances preload around the viewed image may be configured in settings.

 **NOTE!** The preload icon is not displayed, if the series or study images are loaded.

Once you click the preload icon, preloading starts and progress bar is displayed. The stored series can be scrolled interactively in the form of scrollable image stacks.

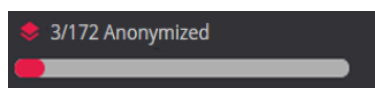

Figure 21. Preload progress bar

NOTE! The system checks the loaded CT, MR, or PT series, or NM multiframe image, and displays the phase filter, if series or multiframe contains images of several phases.

NOTE! The localizer images are separated as phase, if included in series. Contact your system administrator to configure moving the localizer images to separate series at data preparation.

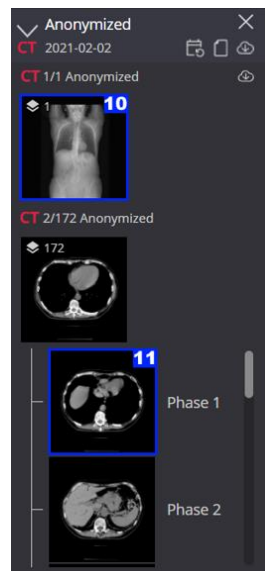

Figure 22. CT series default view without images thumbnails, and with phase filter

- Remove all the studies from Viewer window by clicking on **Close studies** button (number 9) at the bottom of the Thumbnail zone.
- Open images in the following ways:
 - To open any series in the viewport, drag the series description (number 6) to that viewport. System displays the first series image in the viewport, and automatically starts series images preload;
 - To open any image from series with images thumbnails (number 8), find the image thumbnail and click it to open in active viewport, or drag it to selected viewport. If the image is currently viewed, the image picture is highlighted;
 - To open series with only one series thumbnail image in the active viewport, click the series thumbnail (number 10), or drag it to selected viewport. In the viewport system displays the image which was used for generating thumbnail, that is first or middle image in series. The series thumbnail image is highlighted, if at least one series image is displayed in viewer;

NOTE! Quick series images preview cannot be done for CT, MR, PT and NM series, and also the for the multiframe that is displayed as series of images, if not displaying thumbnails is configured. Use scrollbar cursor dragging in viewport for quick series images preview.

NOTE! The automatic series preload for better scrolling performance may be done on CT, PT, MR series opening, if not displaying thumbnails is configured (see in section “Scroll”).

- To open the phase images in the active viewport, click the selected phase thumbnail (number 11), or drag it to selected viewport. The middle of the phase images is displayed, and you can see images of the phase by scrolling forward and backward.

By default, you can open the image in the active viewport with single left mouse button click on the thumbnail.

NOTE! If image opening with single left mouse button click is disabled in settings, the left mouse button double click should be used.

You also may open the image in the empty viewport, instead of opening it in the active viewport, with right mouse button click. The system searches for the empty viewport, and opens the image in this viewport. If there is no empty viewports available, the system automatically extends the layout, and then opens the image in an empty viewport.

NOTE! The automatic layout extension is done only if the current layout has not more than 16 viewports.

NOTE! By default configuration, image opening in empty viewport is disabled. The option should be enabled in system settings, if needed.

NOTE! Use the Study window (see description in section “Series”) as an alternative way to perform the actions: view study description and image thumbnails, preload series images, view the selected image, close the selected study.

View zone

The view zone takes the largest part of the Viewer window and is designated to view and analyze the images. The view zone may be divided to several sections, each section (dashed line in Figure 16) working as separate viewport. The manipulation is allowed in one active viewport at a time. To activate the viewport, click on the viewport area – the active viewport is highlighted. The toolbar and quick menu are automatically adjusted according to the content of the active viewport.

At the right side of the viewport a scroll bar is shown. A scroll cursor is scrolled respectively to the position of the active image in the series. At the bottom of the scroll bar the total number of images in the series and the number of the active image are shown. Dragging the cursor along the scroll bar scrolls through the images of the series. Clicking on scroll bar displays the image corresponding to the scroll position.

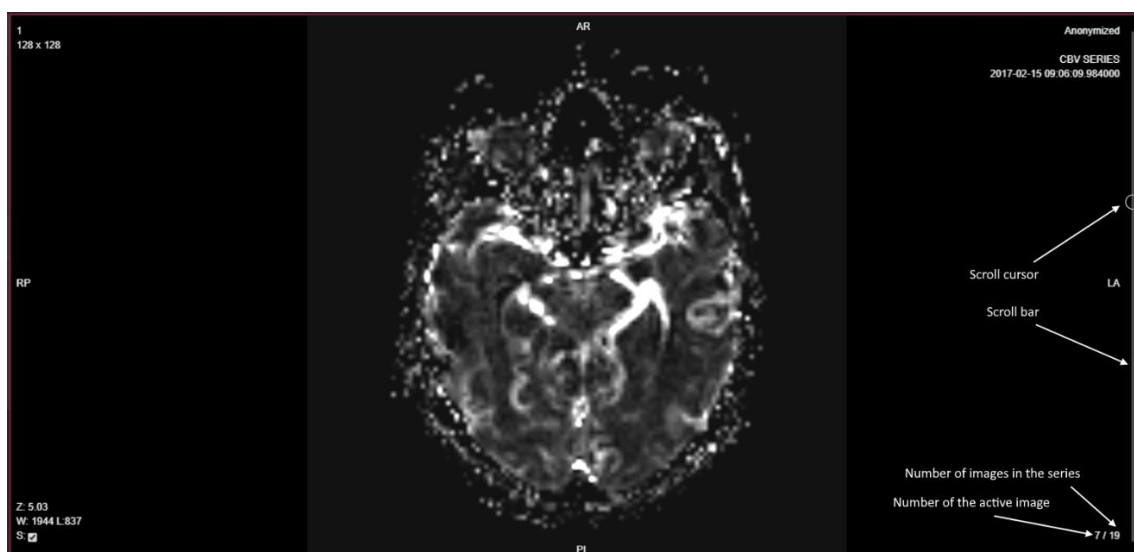

Figure 23. Image scroll bar

NOTE! By default configuration, the scrollbar is displayed for the series of CT, MR, PT, OPT, NM, MG, OT, and OCT modalities, and having two or more images. Contact your system administrator for system configuration.

The system shows the additional information about the displayed image in the viewport info labels:

- The data from the image DICOM file may be displayed at the top right and top left corner of the image. Fields to be displayed are configurable. Label highlighting may be configured for marking the comparison studies. See settings section “Label Properties” for configuration description.

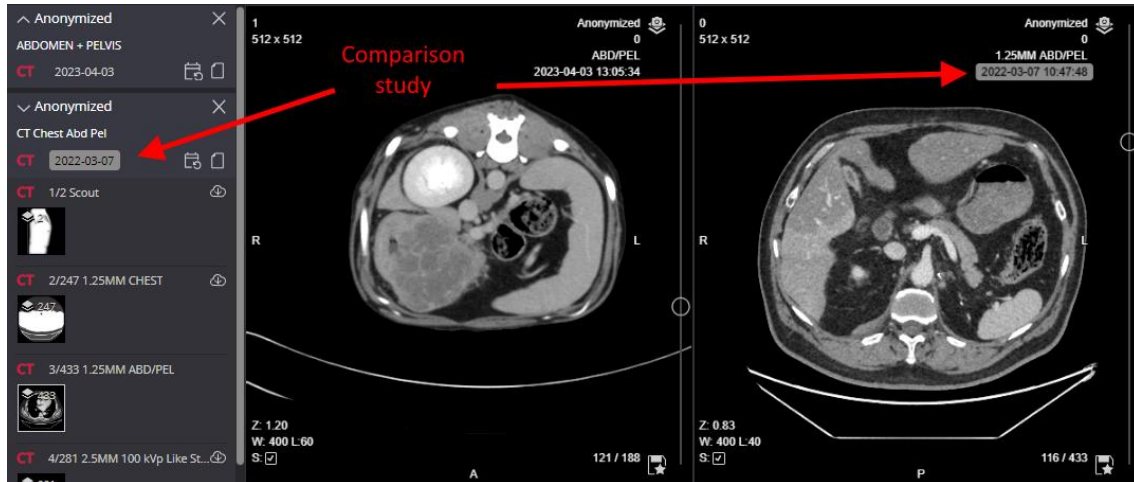

Figure 24. Comparison studies marking

- The anatomical directions, if available in the DICOM data, are displayed in the middle of each viewport side. The directions are automatically recalculated, if the image is rotated or flipped.
- The number of displayed images, and the total number of images in series are displayed in the bottom right corner of the viewport.
- The labels in the bottom left corner of the viewport notifies about applied transformations:
 - Applied brightness and contrast values. For positron emission tomography (PET) images, the brightness and contrast is not displayed. Instead, the maximum pixel value is displayed, and the standardized uptake value (SUV) may be calculated and displayed:
Max: BQML 14636.00, SUV 5.05;
 - Applied VOI LUT value;
 - Applied color palette;
 - Image zoom level;
 - User entered calibration value;
 - Intensity of the point, if intensity measuring is switched on;
 - Magnification coefficient, if magnification tool is used;
 - Rotation and flip values;
 - Plane of reconstructed series, if reconstructed series is displayed;
 - Actual calculated frame rate, if multi-frame is playing and showing actual fps is configured;
 - Series scan direction and slice distance (position) in scan axis. The function should be enabled in settings and is displayed only for CT, MR, PT, and NM series.

NOTE! Use **Info Labels** tool to hide or show the viewport labels (see in section “Info Labels”).



CAUTION! Use the patient's name, dates, anatomical direction and other information, which is displayed in the viewport labels, to ensure that you are viewing the right image.

Viewport toolbar

Viewport toolbar holds the tools, that are accessible directly from the viewport. The area for the toolbar is allocated at the right side of the viewport, on the left of the scroll bar, if scroll bar is displayed in the viewport.

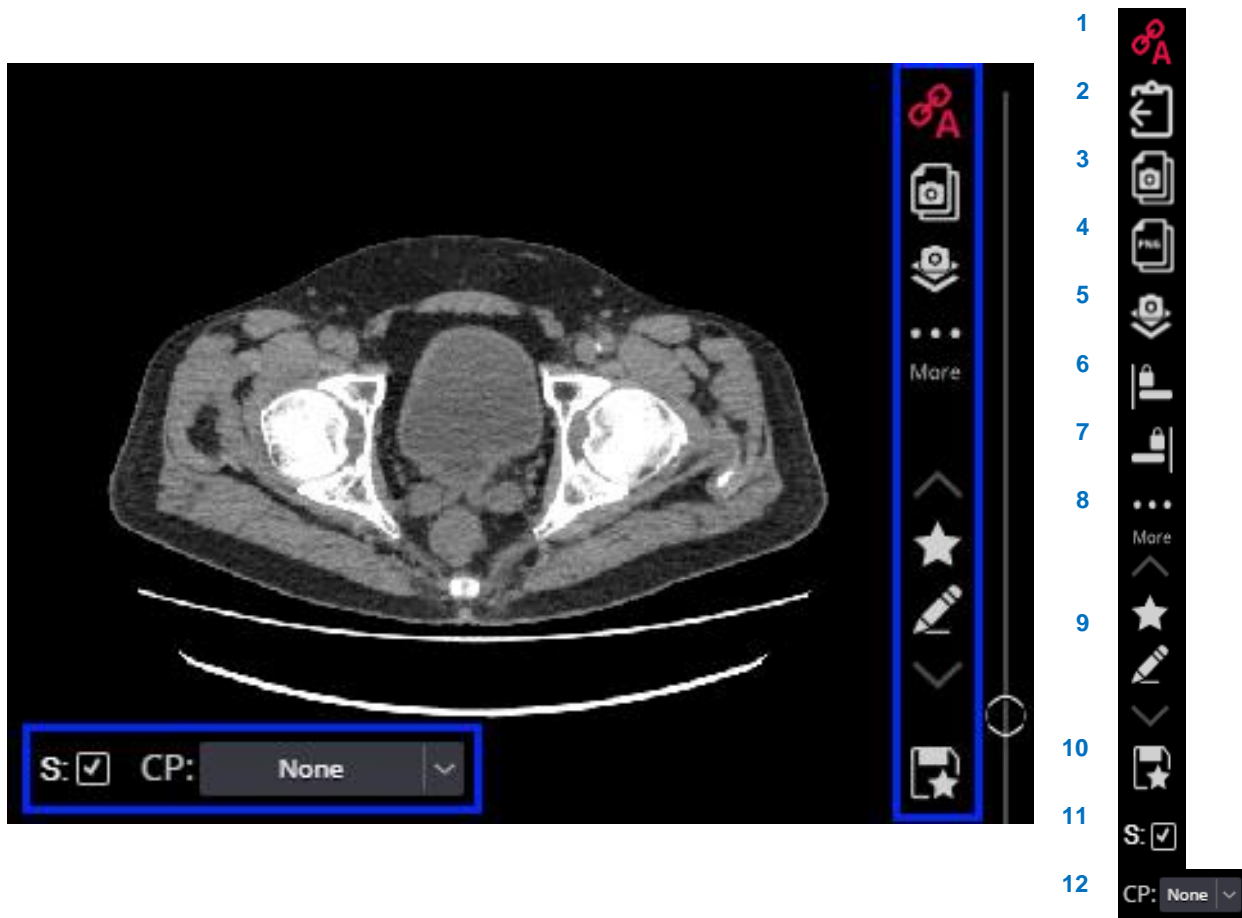











Figure 25. Viewport toolbar

The following tools are accessible from the Viewport toolbar (see control numbers in figure “Viewport toolbar”):

- | | |
|---|---|
|   | <p>1. Enable or disable the synchronous scrolling for a particular series by tapping the manual or automatic link button (number 1) in the Viewport toolbar. See detail functionality description in section “Link scrolled series”.</p> |
|  | <p>2. Paste the copied measurement on the image by tapping the Paste measurement button (number 2) in the Viewport toolbar. See detail functionality description in section “Copy and paste measurement”.</p> |
|  | <p>3. Copy the image and other content, that is displayed in the viewport, to the clipboard by tapping Copy viewport content to the clipboard button (number 3) in the Viewport toolbar. See detail functionality description in section “Copy viewport content”.</p> |
|  | <p>4. Copy the image, that is displayed in the viewport, to the clipboard by tapping Copy original image to the clipboard button (number 4) in the Viewport toolbar. See detail functionality description in section “Copy original image to the clipboard”.</p> |
|  | <p>5. Save the image and other content, that is displayed in the viewport, as secondary capture image by tapping Save viewport content as secondary capture DICOM button (number 5) in the Viewport toolbar. See detail functionality description in section “Copy viewport content”.</p> |
|  | <p>6. Align and Capture Left aligns the image to the left and keeps it aligned when working with all images in a series.</p> |
|  | <p>7. Align and Capture Right aligns the image to the right and keeps it aligned when working with all images in a series.</p> |
|  | <p>8. If there is not enough space for the buttons to be displayed, the More button is displayed. Click the More button to see the missing buttons.</p> |





9. View the additional data of the image using the Quick access to additional data buttons (number 6) in the Viewport toolbar. See detail functionality description in section “Quick access to additional data”.



10. Quickly save the key object and annotations by tapping Quick save button (number 7) in the Viewport toolbar. See detail functionality description in sections “Annotations” and “Key Objects”.

 **NOTE!** System displays notification about ongoing process and temporary deactivates buttons **Copy original image to the clipboard**, **Save viewport content as secondary capture DICOM**, and **Quick save** to prevent the repeated clicks.

 **NOTE!** System deactivates buttons **Copy original image to the clipboard**, **Save viewport content as secondary capture DICOM**, and **Quick save** in order to prevent the unintentional clicks while other mouse workflows, like measurements, are activated in the viewport.

 **NOTE!** The tool button in the Viewport toolbar is displayed only if it is applicable according to the Viewer configuration, the user actions, or the viewport content.

The following controls may be displayed in the viewport (see controls at the bottom left corner in Figure 25):



11. Smooth thick-box for image and multi-frame image. By default, smooth should be applied when the image is opened. If the user unchecks the smooth tick-box, the system displays the image without smoothing and saves the information in browser’s local storage. The smooth will not be applied for the images of this modality until the smooth option is not changes once more, or the browser’s local storage is not cleared.

 **NOTE!** The text and symbols may be distorted when smooth is applied on reports saved as secondary capture images.

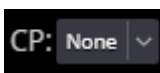

 **NOTE!** The smooth is not applied, and the smooth check box is not displayed, if the smooth is switched off in system configuration.





12. Color palette selection box for monochrome images. The displaying of the color palette selection box is controlled from Windowing tool menu, and allows to apply the color palette to monochrome image (see in section “Color palette for monochrome images”).

Copy viewport content

If image, video or multi-frame is viewed in the viewport, the system provides two options for copying and saving of the viewport content:

- The Copy viewport content to the clipboard  button in the Viewport toolbar converts the viewport content to png format and copies it to the clipboard. When copied, the clipboard content may be pasted to any source, that supports png format.
- Save viewport content as secondary capture DICOM  button in the Viewport toolbar converts the copied viewport content to secondary capture DICOM and stores it on the PACS. JPEG baseline transfer syntax is used for storing the captured content. The stored image is automatically displayed as a new instance in the **Secondary captures** series, which is typically the last series in the study.

 **NOTE!** Content of the viewport, that displays the 2D or 3D reconstructed series, may also be copied to the clipboard or saves as secondary capture.

 **NOTE!** Saving viewport content to DICOM function is available only if the used study storage provides DICOM saving functionality.

The viewport content is copied as described:

- The size of the clipboard image is the same as the size of the viewport's area;
- The viewport's pixels are copied as follows:
 - The currently viewed image or frame, as it is displayed in viewport after all the transformations, like rotation, zoom, windowing, is copied;
 - The fused PET image pixels are copied;
 - If copying to the clipboard, all the viewport labels, as displayed in the viewport, are copied. For the viewport labels with active control (like smooth check box), the current selection is displayed instead of the control;
 - All the measurements with labels, annotations, as displayed in the viewport, are copied;
 - All the segments, as displayed in the viewport, are copied;
- The following viewport's elements are not copied:
 - Scroll bar is not copied;
 - Viewport toolbar tools (icons) are not copied;
 - Other toolbars (like fusion toolbar, multi-frame toolbar) are not copied;
 - If saving viewport content as secondary capture DICOM, the viewport labels and the viewport labels with the controls (like smooth check box) are not copied.

Copy original image to the clipboard

If image is viewed in the viewport, the Copy original image to the clipboard  button is displayed in the Viewport toolbar. Clicking the button converts the original content of the image, that is currently displayed in the viewport, to png format and copies this png image to the clipboard.

 **NOTE!** Copying of the original image to the clipboard function is disabled in default system configuration.

Quick access to additional data

 **NOTE!** Medical image is qualified as image with additional data if either there is at least one presentation state saved for the image, or the image is marked as belonging to at least one saved or not saved Key object, or both conditions are met.

If series, that is viewed in the viewport, contains images with additional data, the controls for quick access to additional data are displayed in the Viewport toolbar:

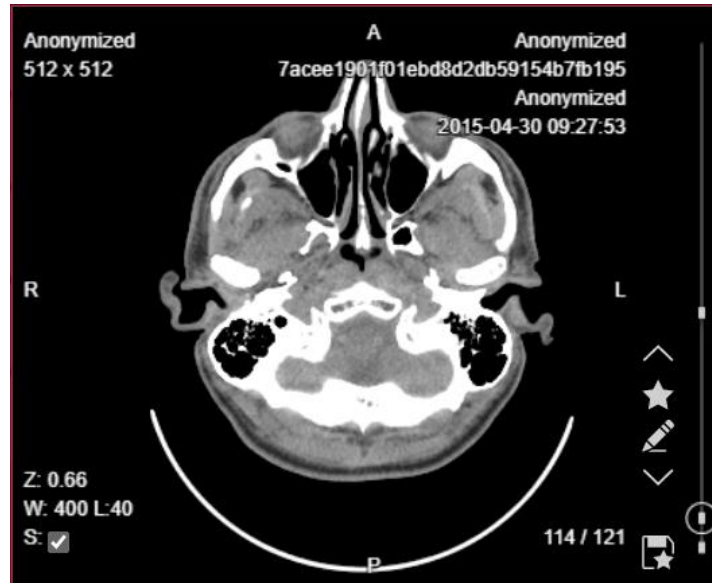







Figure 26. Quick access to additional data controls

To access the images with additional data and additional data, use quick access controls as described below:

- If scrollbar is displayed, marks on scrollbar  indicates the place of images with additional data within series. Click on marked place of the scrollbar to open the image with additional data.
- Use up-pointing chevron  button, and down-pointing chevron  button to navigate through the images with additional data in currently viewed series:
 - The chevron buttons are displayed only if series contains more than one image;
 - Click the up-pointing chevron button to navigate from the currently displayed image to the previous image with additional data in the series. The chevron button is grayed and inactive, if there isn't any image with additional data from the currently displayed image to the begin of the series;
 - Click the down-pointing chevron button to navigate from the currently displayed image to the next image with additional data in the series. The chevron button is grayed and inactive, if there isn't any image with additional data from the currently displayed image to the end of the series.
- Use Key object button  to view the series Key objects and to set the Key object filter (see in section “Key Objects” for detail description). Key object button is grayed and inactive, if currently displayed image does not belong to any Key object.
- Use Annotation button  to view and to open the saved annotation (see in section “Annotations” for detail description). Annotation button is grayed and inactive, if currently displayed image hasn't any saved presentation state.

Color palette for monochrome images

If monochrome image is viewed in the viewport, and the user enables the color palette selection for the series, that is displayed in the active viewport (see in section “Windowing”), the system displays the color palette selection field in the viewport. By default, the image opens in greyscale, and none color palette is applied. The user can apply the color palette:

- Expand the color palette selection field and select the palette, if you want the color palette to be applied:

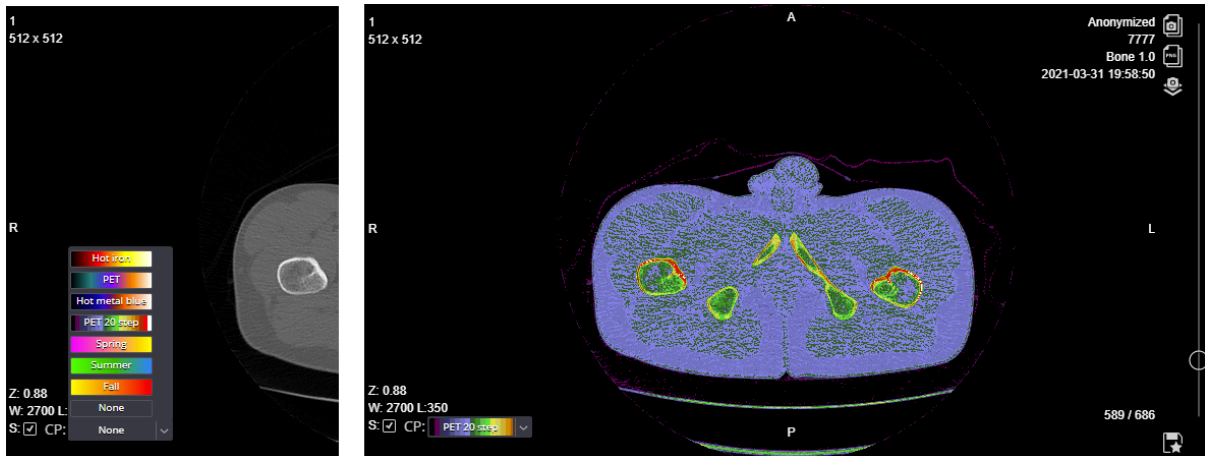

Figure 27. Color palette selection and applying

- Select do not apply color palette (“None” options) to see again the greyscale image in the viewport.

NOTE! Disabling the Color palette selection in windowing menu automatically clears the applied color palette in the active viewport.

NOTE! The color palette is automatically disabled if the other series is opened in the viewport, or the other instance type is opened for the same series.

By applying the color palette, inversion can be applied too. The color set of an inverted CP is the same, but the start and end of the color gamut are reversed (for example if the first color was yellow and the last color was red, after the inversion the first color be red and the last color yellow).



Figure 28. Inverted color palette

NOTE! If the colour palette is applied to an inverted image for the first time, inversion is automatically switched off. If inversion is switched on after applying the CP, inversion is kept switched on.

Quick menu

A **quick menu** appears with a right-click mouse operation on the viewports' area. A quick menu offers tools that have been chosen to be included in a quick menu via Settings (refer to the “Settings” chapter for more information).

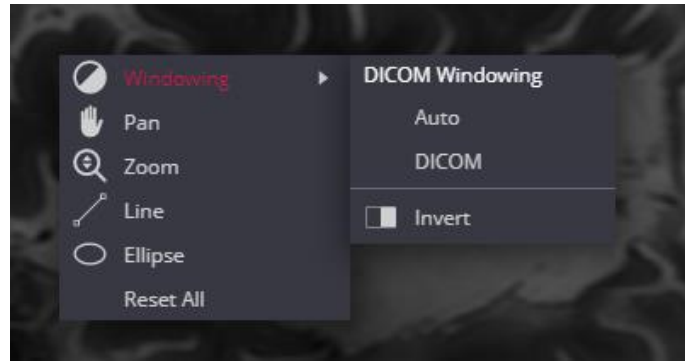

Figure 29. Quick menu

If it is specified via Settings that the thumbnail zone is accessed from the quick menu, right-click mouse operation at a selected point in the viewport displays the thumbnail zone on the right of the click point, and the quick menu on the left of the click point.

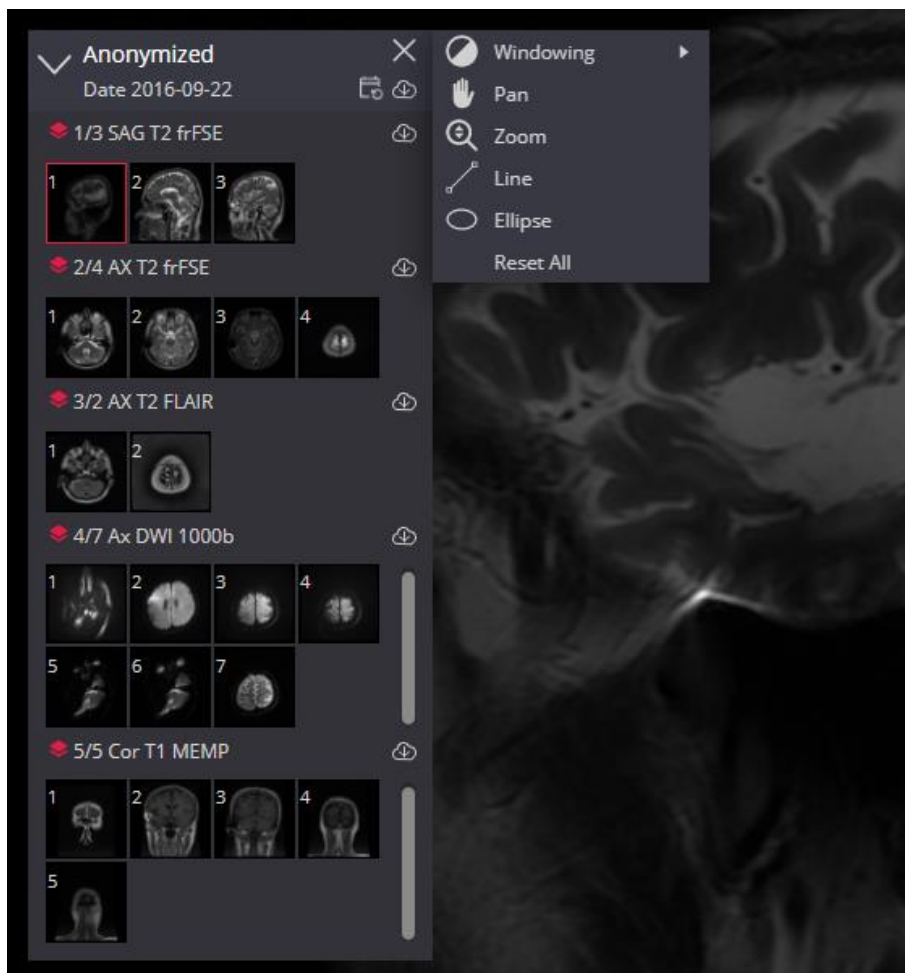

Figure 30. Quick menu with thumbnail zone

Opening studies

NOTE! The section described how to open the studies in Viewer window from the Search results list in Search window. For a description of opening studies in mobile mode, see in section “Opening studies in MedDream Mobile mode”. If Viewer is used in an integrated solution, the window is opened by an integrating information system, such as a hospital information system or a patient portal.

NOTE! See in sections "Patient studies window" and "Patient history" for detail description how to open the studies from the Patient studies list.

NOTE! To view the image of the study that is already opened in Viewer's window, drag the image picture from thumbnail or use the Series menu (see in section “Series”).

If you need to open the study, please do the following:

1. Find the study in search results list (the active line is highlighted when scrolling through list) and click on it.

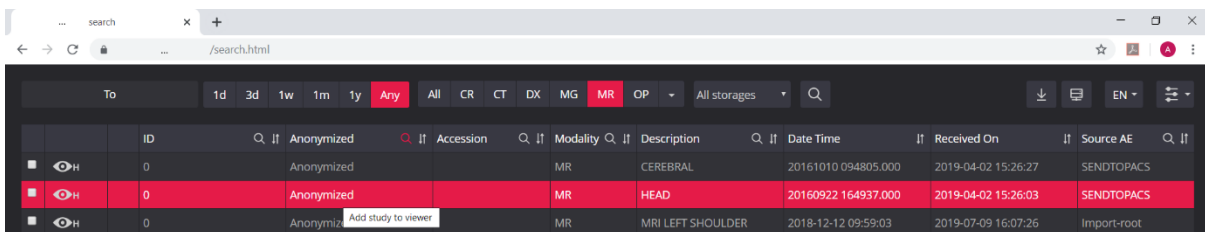

Figure 31. Study selection in the search results list

2. A new browser tab will pop up and Viewer window with selected study opens in it:

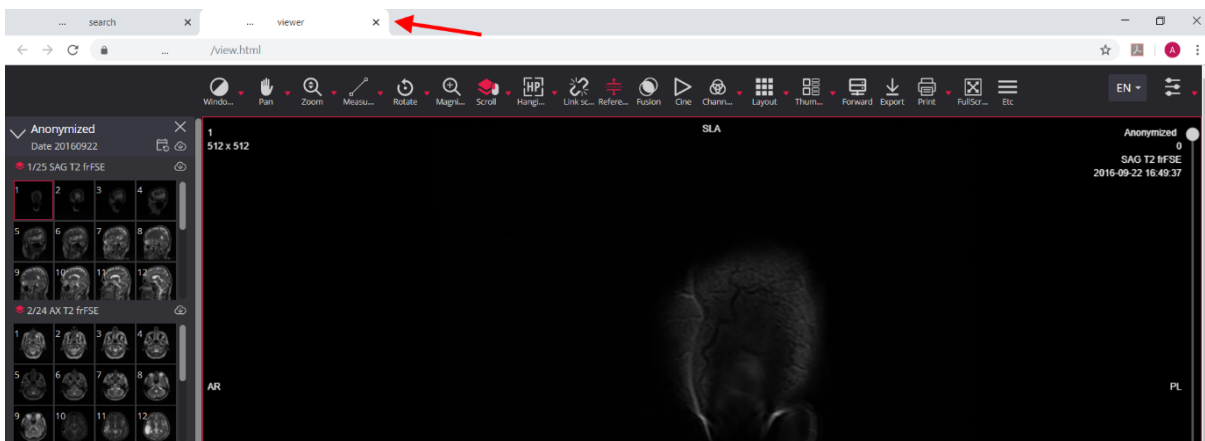

Figure 32. Viewer window in new tab

NOTE! The image of the first series opens, if Auto Open Image conditions are met (see description in [Settings](#)).

NOTE! If one series thumbnail is configured for modality, the first or middle instance is opened depending on configuration.

3a. If you need to open more than one study in the same Viewer window (e.g. to compare images from different studies), please do the following:

- From Viewer window tab go back to the Search window tab.
- Find and click the study in search results, as described in step 1.
- The Viewer tab automatically activates and the selected study is opened in Viewer window. The study description is displayed at the bottom of the thumbnail zone and expanded. Descriptions of all the previously added studies are collapsed:

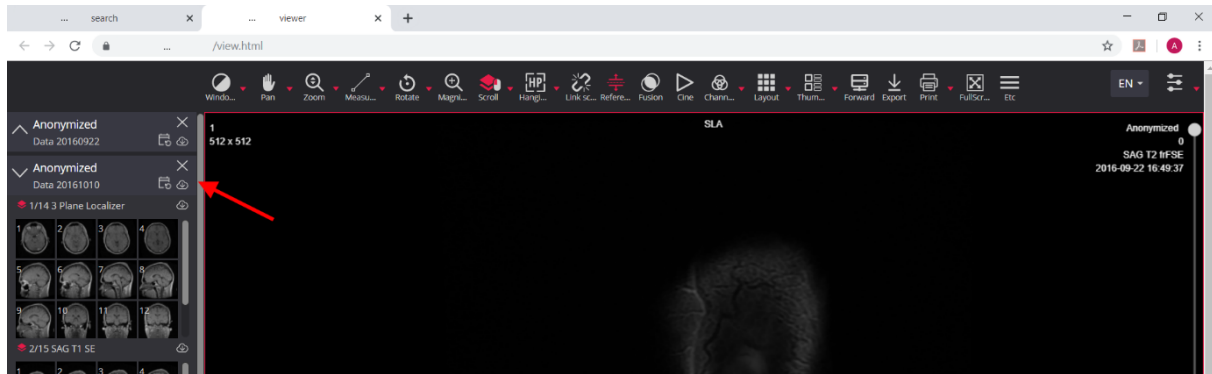

Figure 33. New study opened in the same Viewer window

NOTE! In case the first study image should be opened according to [Settings](#), the image is opened in the first (top right) viewport and only if this viewport is empty.

NOTE! Repeat the actions of this step, if you need to open the third or more studies in the same Viewer window.

3b. If you need to open the study in a new Viewer window, please do the following:

- From Viewer window tab go back to the Search window tab.
- Find the study in search results and click it holding the CTRL key pressed down.
- The new browser tab pops-up and the new Viewer window with selected study opens in it.

Patient studies window

Patient studies window is displayed in the following conditions:

- URL with parameters is used for opening the studies in the Viewer,
- the passed URL parameter is patient ID for only one patient,
- and the system is configured to show Patient studies window instead of directly opening the studies in the Viewer window.

Patient studies window displays the **Patient studies list**, that is retrieved based on patient ID and storage data in URL:

PATIENT STUDIES

Anonymized — 0[STOWRS-10.2.29.30-20190805100743]

	<input type="checkbox"/>	ID	Name	Modality	Description	Date Time	Source AE
2023	<input type="checkbox"/>	0[STOWRS-10.2.29.30-20190805100743]	Anonymized	OPT		2022-10-06 14:14:03	SENDTOPACS
2021	<input type="checkbox"/>	0[STOWRS-10.2.29.30-20190805100743]	Anonymized	PR, KO, MR	R/KNEE	2022-09-22 00:35:05	MEDDREAM
2017	<input type="checkbox"/>	0[STOWRS-10.2.29.30-20190805100743]	Anonymized	PR, MR, SR	BRAIN CRANIAL	2022-09-19 20:14:49	MEDDREAM
2014	<input type="checkbox"/>	0[STOWRS-10.2.29.30-20190805100743]	Anonymized	PR, MR	RMN DELL ADDOME COMPLETO, S	2022-09-16 15:44:09	MEDDREAM

Figure 34. Patient studies window

You can sort, search, and open studies from Patient studies list (see detail functionality description in section “Patient history”).

NOTE! The system may be configured to display the different study information in patient studies window and patient history window.

NOTE! It is not possible to sort and filter the patient’s studies list if working in mobile mode.

NOTE! You won’t be able to reopen the Patient studies window from the Viewer. But the patient studies list may be accessed in Patient history window, if the patient history viewing is allowed.

Patient history

Patient studies list provides a quick overview of all patient research history. The Patient history window opens by clicking the displayed patient’s history icon  in thumbnail zone, or Series modal of the Viewer window:

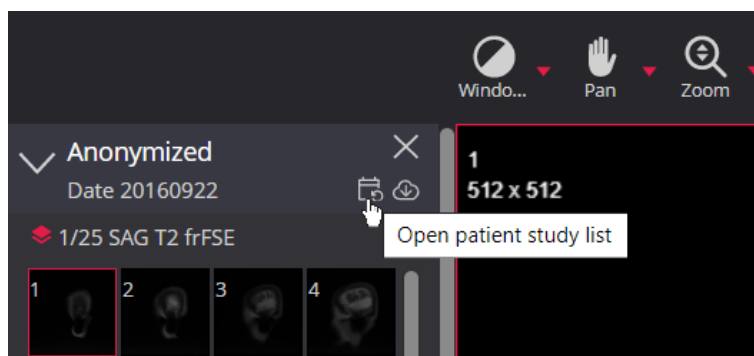

Figure 35. Opening the Patient history window from the header of viewed studies

NOTE! The patient’s history icon is visible only if the viewing patient’s history is allowed by system configuration, and the user rights.

Patient history window displays the patient studies:

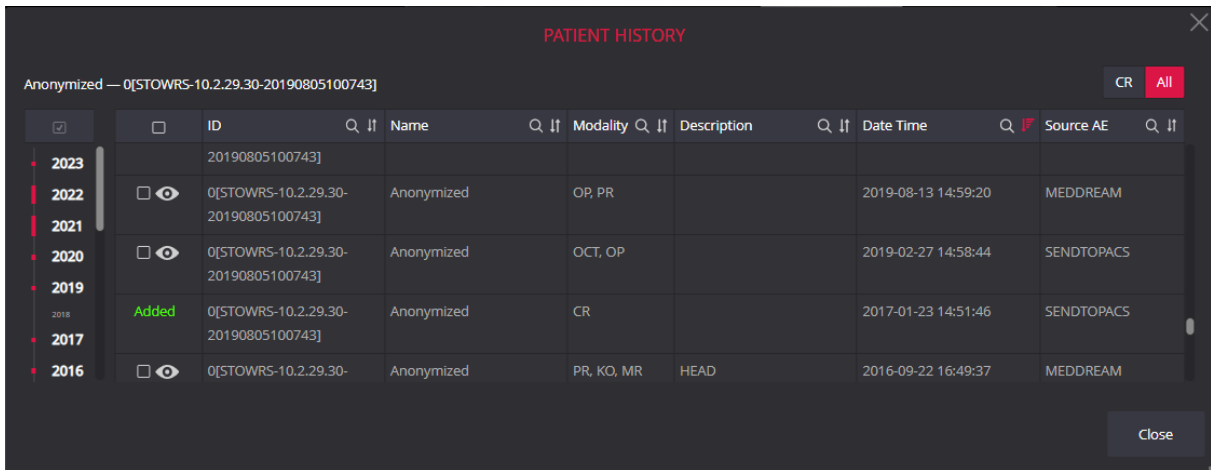

Figure 36. Patient history window

NOTE! The system may be configured to search for patient studies either in all storages, or in the storage of the viewed studies.

CAUTION! Be aware, that access to the storages may be restricted by the user rights. If search for patient studies is configured in all storages, searching is performed in the storages, that are granted for the user.

By default, the following study information is provided in **Patient studies list**:

- **ID** - patient's identification number,
- **Name** - patient's name and surname,
- **Modality** - the method which was used to obtain the study images (modality),
- **Description** – the study description,
- **Date Time** – study date and time,
- **Source AE** – device from where the study was sent to the PACS.









NOTE! The system may be configured to display other study information in patient studies list.

You can use the modality filter at the top right corner of the Patient history window. Possible filter options:

- The modality of the study from which the Patient history window was opened (**IO** in the figure);
- **All** patient historical studies. This option is the default value when you open history window.

You can do the following action in **Patient studies list**:

- Sort the patient studies list. Sorting is possible by all columns. The sort-related functionality:
 - By default, the list is sorted in descending order by **Date Time** when patient studies list is displayed.

- To sort the list according to the selected column, or to change the sorting order, you need to click the sort button in the in the heading of the selected column. The action performs the sort and changes the sort icon as follows:  sorted ascending,  sorted descending,  unsorted.
- It is allowed to sort only by one column at a time. Sorting by another column automatically cancels the previous sort.
- To filter or search the studies list:
 - To apply the modality filter, click the modality button in the top right corner of the patient history window  . The highlighted button indicates, that modality filter is applied. Click "All" to reset modality filtering.
 - To view the studies for a particular year, use year filter on the left of the window. Click the year that has studies indicator on the left, and the highlighted year  indicates, that year filter is applied. You may filter the studies for several years by holding CTRL button pressed and clicking the years in the year filter. The option "NA" is available at the end of the filter, if there are studies without study date. To remove the particular year filter, click on the highlighted year. The check box at the top of the filter removes all the year filters.
 - Filter/search is possible by all columns with a search icon . To perform a search, click on the column name – the system highlights the search icon and search criteria input field. Enter a search phrase in the highlighted input field - the system automatically filters the list based on the text you enter. The columns with an active filter have highlighted search icon  in the column header.
 - Note, that it is allowed to have different filter applied at a time.
- Open the patient study for viewing:
 - To open one study, click on the eye icon  in the first column of the studies list.
 - To open multiple studies at once, mark the tick-box next to the studies you want to open and click the **Add studies to viewer** button. All the studies, that currently displayed in the list, may be marked or unmarked at once by clicking the tick-box in the header of the first column.
 - All the studies, that are already opened in Viewer, are highlighted as **Added** and haven't controls for opening.

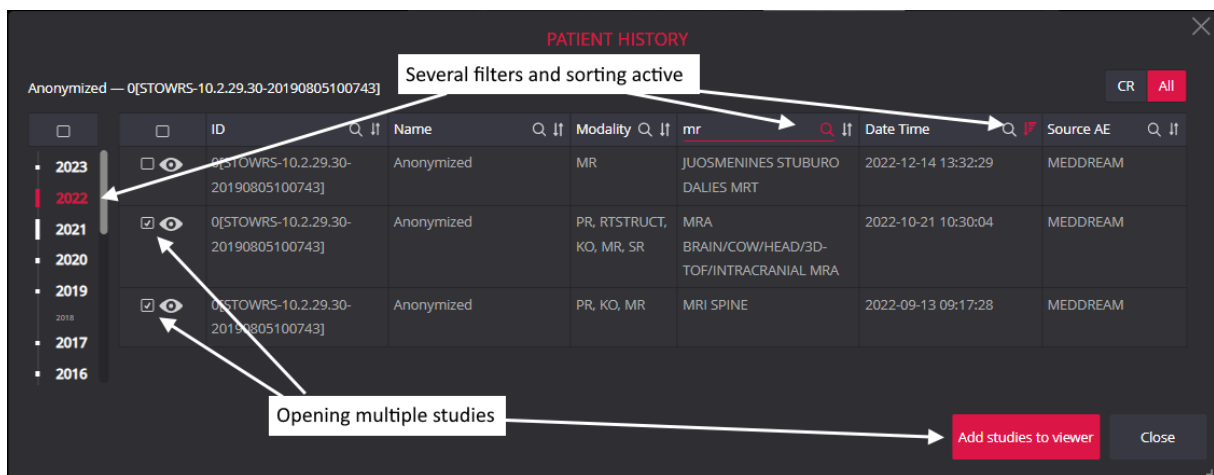



Figure 37. Searching and opening several studies from Patient history window

 **NOTE!** It is not possible to sort and filter the patient's studies list if working in mobile mode.

 **NOTE!** By default, patient history search is performed according to the *Patient ID*. Contact your system administrator regarding the system configuration, if multiple patients ID are displayed.

Tools for image manipulation and analysis

NOTE! In section “Toolbar Properties” you can configure, what buttons and in what order are shown in toolbar.

To adjust and to analyze the study images according to the criteria you need, use the image manipulation tools:

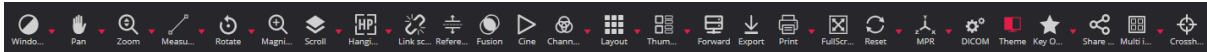



Figure 38. Image manipulation tools

Windowing



Windowing button is used to adjust image contrast and brightness (Level and Window values). You can change the brightness using the mouse or from menu.

For changing the brightness with mouse, assign the mouse button to Windowing function . Hold down the assigned button and drag the mouse upwards or downwards (to change Level values), and right or left to change Window values.

The windowing values may be applied for the same series in different viewports. By default, this feature is disabled, and you should use the **Sync Windowing for Same Series** menu to enable it.

NOTE! Sync Windowing feature is also applicable for the reconstructed orthogonal series.



Also, you can click the red triangle on the right of the button and select the windowing from the menu:



Figure 39. Window button menu example

The brightness level menu consists of static and dynamic elements - groups and options. Dynamic menu elements are only displayed if they are applicable to the active image.

The description of Windowing menu elements:

- Static group **DICOM Windowing**. Group contains the following options:
 - **Auto** – the system analyses the image and adjusts the brightness and contrast automatically. Static menu option. Auto windowing is applied, if no other options available in DICOM Windowing group.
 - Dynamic menu options - all the Window and Level value pairs from image DICOM data: windowing title, w value, and l value are displayed. The first option is automatically applied, if available.
- **VOI LUT** (*Value Of Interest Look-Up Table*) dynamic group is displayed only if VOI LUT configurations are found in image DICOM file. This transformation gives greater weight to the range of values of interest. The DICOM Standard Window Center and Window Width are linear VOI LUT where only 2 parameters are specified - center and width of the interval. Meanwhile, the non-linear VOI LUT uses a free shape curve in the form of a table. In MedDream user environment VOI LUT is called non-linear transformation.
 - The VOI LUT group displays all VOI LUT configurations that are available in the active image DICOM file. The names of VOI LUT configurations specified in the DICOM file are displayed. If VOI LUT configurations exist, the first VOI LUT configuration is automatically applied, along with Auto w and l values.
- The **Color LUT** group displays the **COLOR PALETTE** menu, if COLOR PALETTE is found in image DICOM file. If there is a Color Palette, it will be applied during the study loading process. After applying another Window Leveling perfusion, the Color palette will not be applied automatically. To apply the color palette after changing the windowing level, click the **COLOR PALETTE** menu.
- **Custom Windowing** dynamic group holds the custom windowing options that are define in settings (see in section “Windowing settings”), if the active image modality adheres to settings.
- **Invert** – the static option that is used to invert the image.
- **Sync Windowing for Same Series** – static option that allows applying windowing values for the for the same series displayed in different viewports (including MPR projections). Windowing synchronization is enabled if the synchronized windowing icon on the left side of the menu is highlighted . Windowing synchronization settings are stored in your browser's local storage and only apply to the same browser.
- **Color Palette Selection** – static option that enables applying color palette for the series in the active viewport (see in section “Color palette for monochrome images”). Color palette selection is enabled if icon on the left side of the menu is highlighted .

Shortcuts can be used to change values of windowing:

- The **Auto** is linked to shortcut [0] by default;
- The **DICOM** value is linked to shortcut [1] by default; if there is more than one value in the DICOM, the shortcut is linked to the first value and the next value has no shortcut.
- **Custom Windowing** shortcuts values are created dynamically from [2] to [9] the order in which the values in the menu are displayed. If you want to change the order of the shortcuts, you have to change the order of the custom values in the settings window.

Auto and DICOM-first values can be assigned additional shortcuts values. For more information see in chapter "Shortcuts".

Histogram



The **Histogram** can be opened from the Windowing menu by selecting the item **Histogram** or by pressing a keyboard shortcut (if one has been assigned by the system administrator).

Histogram - a bar graph showing the distribution of pixel intensity data in an image: the horizontal axis of the graph represents the change in values and the vertical axis represents the total number of pixels for that value. The yellow curve crossing the graph represents the windowing W/L values.

Three graph scales can be selected  :

1. "HU" - fixed scale HU units from -1500 to 2500;
2. "Min-Max range" - scale from the actual smallest pixel value to the actual largest value in the image (scale width and values depend on the open image data);
3. "Full range" - the maximum possible set of values under the pixel intensity storage tag "Bits Stored" ("16": [-32768, 32767]; "12": [-2048, 2047]; "8": [-128, 127]).

It is possible to specify how many bins the data should be split - **Number of bins** (possible values from 32 to 1024).

The user can change:

- the center of the range - the **Window Level (L)**;
- the range of the numbers is referred to as the **Window Width (W)**;
- the **lower bound** of width;
- the **upper bound** of width.

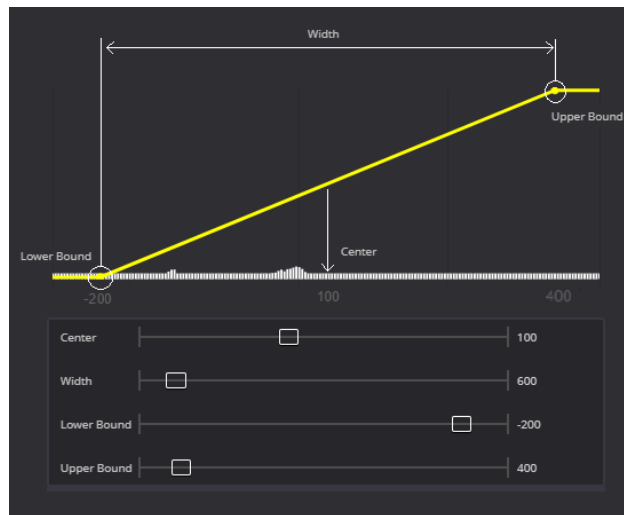



Figure 40. Managing W/L values in the histogram

Values can be changed with the slider bar, by entering values from the keyboard, or by using the arrows to change values within 10 .

NOTE! When entering a value from the keyboard, the system will only apply the entered value when Enter is pressed or when the cursor focus is changed.

NOTE! If the user enters a value lower than the possible value, the system automatically selects the lowest possible value. The system automatically selects the maximum possible value if a value greater than the possible value is entered.

NOTE! You can see the maximum and minimum values in the tooltip that appears when you hover the mouse over the input field.

In the Histogram window it is possible to select DICOM file, Auto and Custom values, in the same way as in the Windowing menu item. It is also possible to invert the image and activate the color palette.

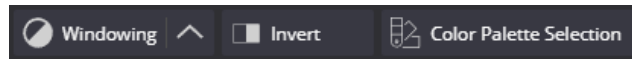
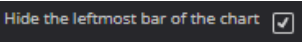
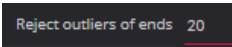

Figure 41. Additional buttons in the histogram window

The window contains a group of additional information



This part contains additional options:

- to unmark the flag to not hide the leftmost bar of the chart 
- the option to specify that reject outliers from ends less than  (the maximum possible value 20).

NOTE! If multiple viewports are open with different studies or different images, the histogram represents the information of the image on which is active.

Rotate the mouse wheel to zoom in on the histogram graph. Zooming in shows a more detailed range of values. The enlarged graph can be viewed by dragging it to any edge of the graph.

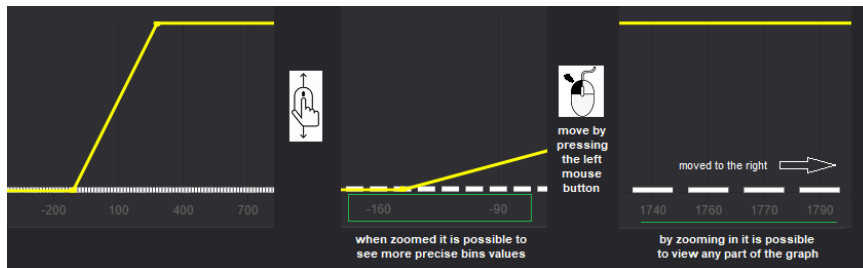

Figure 42. Zoom the histogram graph

For a more detailed view of the number of pixels with specific values, you can scroll the Y-axis slider bar.

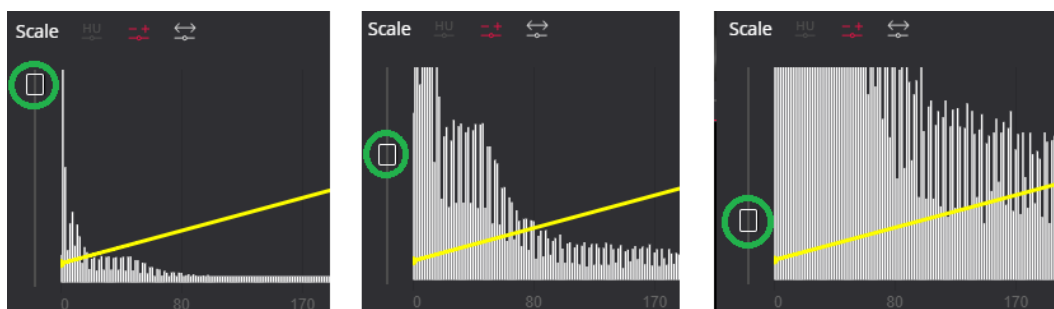



Figure 43. Zooming the Y-axis of the histogram graph

To cancel the zoom, select the button .

Pan



Pan button allows you to position images within the pane. You can change the image position using the mouse or alignment option from menu. This feature is especially useful when the image is larger than the pane, as it usually is after zooming in.

For changing the image position with mouse, assign the mouse button to Pan function . To move an image within the pane:

- press the selected mouse button on the image and drag the cursor to desired place or position;
- release the mouse button to leave the image in its new position.

You can use the Pan menu for changing the image alignment:

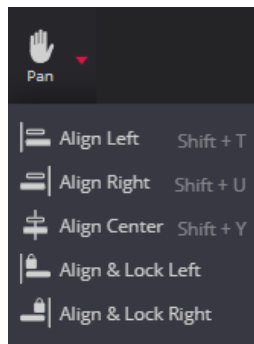



Figure 44. Image alignment options in Pan menu

Menu actions with the additional Lock function  not only align the image but also keep it aligned while working on images of the series. The lock does not allow the images to be moved away from the selected border.

When the Lock menu is activated, icons are highlighted .

To turn off locking, press the highlighted menu item again.

The system automatically turns off locking when you select alignment without locking or when you perform a Rotate action (either with the mouse or by selecting from the menu).

Align & Lock buttons available on the viewport in **MG** images.

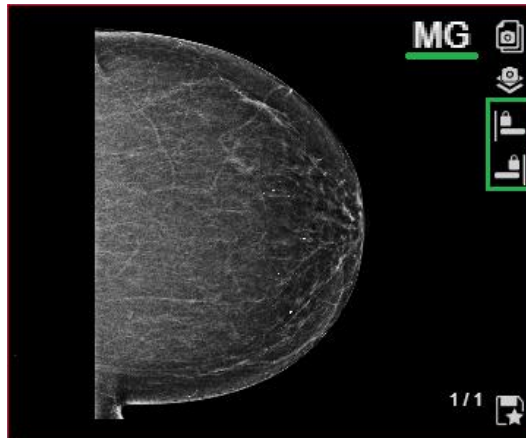

Figure 45. Align & Lock buttons on the viewport

Functionality can be activated which, when Align & Lock is activated, displays all labels and controls (buttons, slider bar, etc.) on the opposite side of the alignment image.

NOTE! Functionality should be activated in the settings.

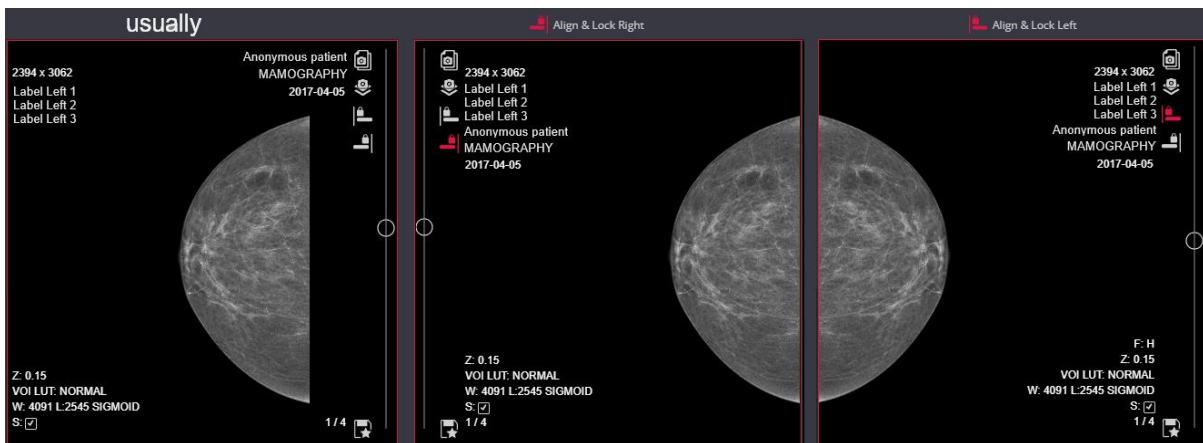

Figure 46. Align & Lock. Control buttons on the opposite side of the alignment

In addition, it is possible to define in the settings which labels must be displayed if the viewport height is small and all labels do not fit. For example, if you specify date and patient name as mandatory and if all labels don't fit, only defined labels are displayed, other labels are not displayed, but "..." is indicated



Figure 47. Align & Lock. Mandatory labels to be displayed

Zoom



Zoom button allows you to enlarge or reduce the image size. You can change the image size using the mouse or zoom option from menu.

For changing the image size with mouse, assign the mouse button to Zoom function . To zoom the image, do the following:

- choose which part of the image you want to zoom in/out,
- place the mouse cursor on the chosen part,
- click the selected mouse button and drag up or down,
- the chosen part will be zoomed in/out.



CAUTION! Be cautious and ensure, that you are viewing the right place, if working with a zoomed image.

Zoom button menu has the following options:

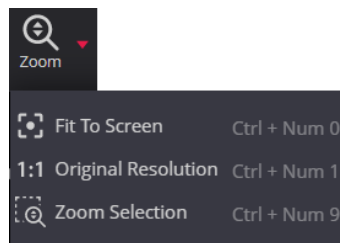

Figure 48. Zoom button menu

When you click **Fit to Screen** option, the size of the image is automatically adjusted so that the image would fill the entire viewport. So, if the image is too large, it is zoomed out, and if it is too small, it is zoomed in.

Clicking **Original Resolution** option, the size of the image changes into original size.

Clicking **Zoom Selection** option activates the area selection workflow in the active viewport:

- press the mouse button, that is assigned to the Zoom tool, at the corner of the region, which you want to zoom;
- drag the mouse to the opposite corner of the region, which you want to view – the system automatically draws the bounding rectangular;
- release the mouse button when the rectangular bounds the region, which you want to be viewed in the viewport;
- the system fits the selected region to the viewport.



NOTE! Rotation, flip, and horizontal alignment is maintained when zooming the selected region.



NOTE! Access **Zoom Selection** and **Fit to Screen** options from quick menu, or by shortcuts for quickly zooming to the region of interest and going back to whole image.

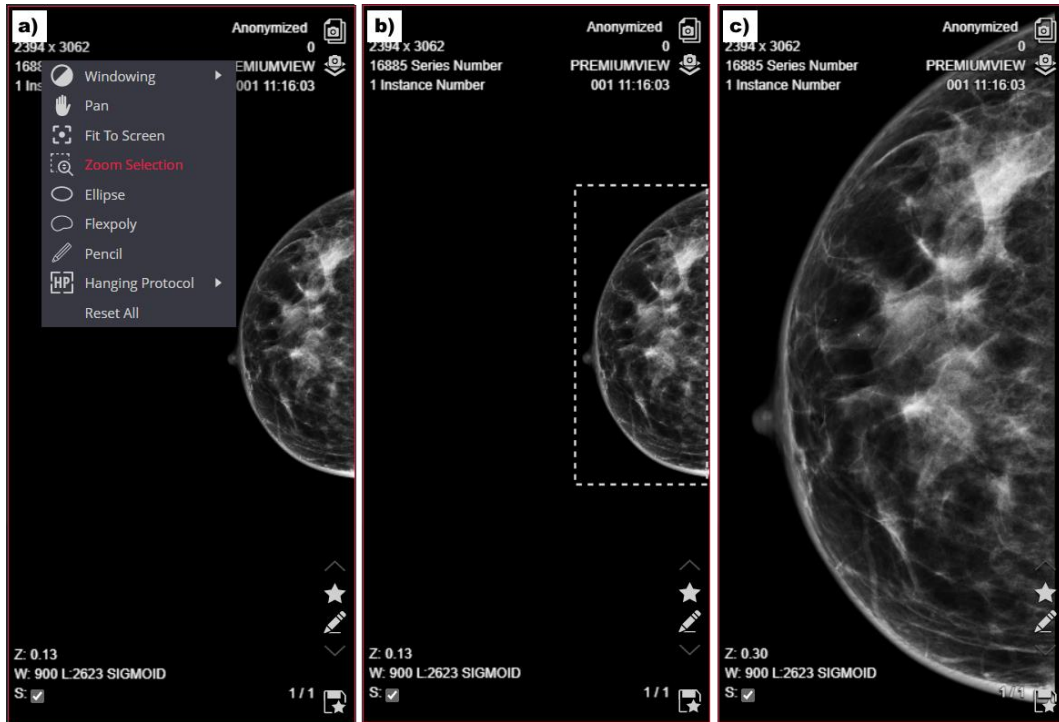

Figure 49. Zoom selection

Zoom selection steps: a) select Zoom Selection in quick menu; b) press and drag mouse to select region in viewport; c) release the mouse button to zoom the selected region.

Channels



Channels highlights a color component or two colors combination component in the image by showing selected color in white shades and other colors in black. This tool is enabled for image view. By default, no color component is highlighted. Click the red arrow in order to choose color(s) from the list:



Figure 50. Color selection in Channels button menu

The selected channel is applied and its icon is displayed on Channels button . To remove the color highlighting, select the **Default** menu option in Channels button menu.

Scroll



Scroll tool enables easy image scrolling with mouse and changing the active series using button's drop-down menu. You can scroll the series images by scrolling the mouse wheel in the desired direction.

For scrolling the series images with mouse without wheel function, assign the mouse button to Scroll function



. Once tapped it enables you to scroll through the series of images by using a vertical drag gesture: drag upwards to scroll towards the series beginning, and drag downwards to scroll towards the series ending.

By default, scrolling is done in scope of current series. To enable the scroll between series, use the **Activate fast scroll between series** menu.



NOTE! Scrolling between series apply for scrolling with mouse and does not apply for scroll bar function.

Scroll button can be extended:

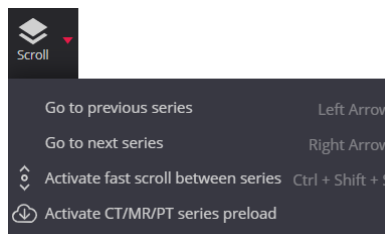



Figure 51. Scroll button menu

- To change the active series, use menu option **Go to previous series** (shortcut - Left Arrow in keyboard) or **Go to next series** (shortcut - Right Arrow in keyboard). In settings this functionality can be included in quick menu, for faster browsing through study series.
- To activate/deactivate of fast scrolling between series with mouse, use **Activate fast scroll between series** option. Series scrolling is enabled if the scroll icon on the left side of the menu is highlighted . The initial value is taken from Activate fast scroll between series setting. If changed, series scrolling settings are stored in your browser's local storage and apply instead of system settings.
- To automatically start series images preload on CT/MR/PT series opening, use **Activate CT/MR/PT series preload** option. Menu option is displayed, only if the not displaying series images thumbnails and automatic preload is configured for CT/MR/PT series, and progressive instances preload is not configures in settings. Automatic series preload is enabled if the preload icon on the left side of the menu is highlighted . Automatic preload settings are stored in your browser's local storage and only apply to the same browser.

Magnifier



Magnifier button is used to magnify (enlarge) a certain area of the image.



Assign the mouse button to Magnifier function . Click the selected mouse button on the desired image place - image area is enlarged. The enlarged area can be dragged to other place of the image in order to magnify it. The small circle shows the center of enlarged area.

You can change magnification in this area with the help of mouse wheel from 1 time (no enlargement) to 50 times. In order to enlarge, press the selected mouse button and scroll the mouse wheel until the desired

magnification is reached. The actual magnification value is displayed on the bottom left corner of the active viewport (M x [magnification coefecient]):



Figure 52. Magnification coefficient of Magnifier tool

To change the magnifier radius, press the selected mouse button, press Alt and scroll the mouse wheel till will reach the required size.

Tool magnification and radius can be different in different viewports.

The last changed values the system will apply in the newly opened viewport and the new session.

Digital Subtraction



Digital Subtraction button is used to subtract a pre-contrast mask image from subsequent images for better visualization of blood vessels in angiography series.

The Digital Subtraction tool is displayed in toolbar only if the active angiography image series or multiframe has the mask data, and the digital subtraction is enabled in configuration.

NOTE! By default, configuration the digital subtraction function is disabled. Contact your system administrator, if you want to use the digital subtraction for angiography series with mask data.

The automatic applying of digital subtraction at image opening may be configured, if subtracted is recommended viewing mode for angiography image series or multiframe. The digital subtraction icon is highlighted , if the digital subtraction is currently applied.



Figure 53. The angiography multiframe image without (on the left), and after the mask subtraction (on the right)

The digital subtraction also can be applied or cleared manually.

Click the highlighted Digital Subtraction button in the toolbar to revert the mask subtraction, and view the original series in the viewport.

Click the not highlighted Digital Subtraction button to subtract the mask from the displayed angiography series. The image tools like windowing, zoom, pan, may be applied for viewing and analyzing the subtracted series.

Montage



Montage button opens the Montage dialog window, in which the user can create the montage from the currently viewed images, and save this montage image as secondary capture DICOM.

To do the montage, click the Montage button with the selected mouse button. The system allows assigning the left, and the middle mouse button for montage tool. The right mouse button may not be assigned for montage tool. The mouse pictogram with assigned button is displayed , and the montage window is opened.

You can add the content of any not empty Viewer viewport to the montage by clicking on the viewport with the assigned mouse button:

- The system copies the viewport content to the first empty viewport in the montage image, if an empty viewport is available.
- If maximum montage layout size not reached, and empty viewport is not available, the system extends the montage layout, and copies the viewport content to the first empty montage viewport. The maximum allowed montage layout is 20 viewports.
- The system copies image pixels, measurements and annotations. The other content, like labels, reference lines, segmentation, fused layer pixels, is not copied.



Figure 54. Montage window

With the buttons in the top right corner of the Montage window, you can do the following:

- Delete the image from the montage by selecting the montage viewport and then pressing the Delete button. The montage layout is not changed and the empty viewports are left after deleting the particular image from montage.
- Reset all the montage by pressing the Reset button. All the images are cleared, and montage layout is set to one viewport.
- Save the current montage image as secondary capture DICOM by pressing the Save button. The system converts the montage image to secondary capture DICOM and stores it on the PACS. The stored image is automatically displayed as a new instance in the **Secondary captures** series, which is typically the last series in the study.



NOTE! Saving viewport content to DICOM function is available only if the used study storage provides DICOM saving functionality.

- Close the Montage window by pressing the Close window button.

Sync actions



Syn action takes the possibility to perform Windowing, Color Pallet, Zoom, and Pan action in several viewports: for the same series or for all viewports where are open images.

Select the menu and check in the drop-down list of actions that want to synchronize. If you want to synchronize all actions - Windowing, Color Pallet, Zoom, and Pan - mark the first group.

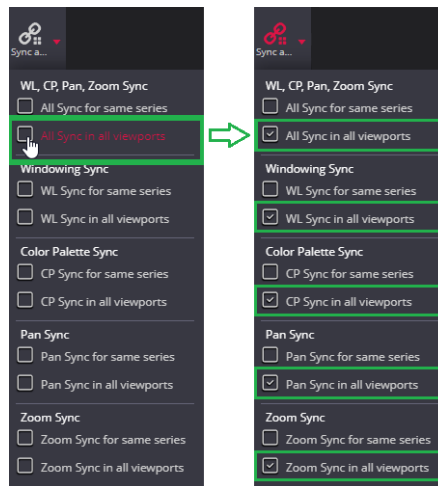

Figure 55. Sync all action

If you need not all actions or different selections, e.g. for Zoom in all viewports and Windowing only in open views in the same series, then select the required items one at a time by reopening the menu.

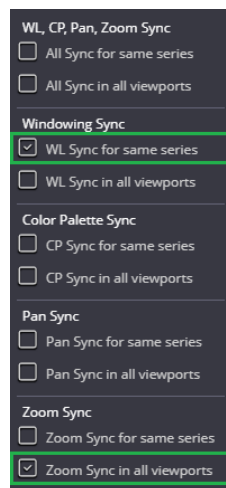

Figure 56. Sync some actions

The selection is saved in the browser's local storage and will be set when starting the viewer next time.

When the attribute is checked, the action is performed synchronously in the same series or in all viewports. For example, the Color Palette will be enabled in all of them, and changing the value in one viewport will change it in the others (or in the same series, or in all).

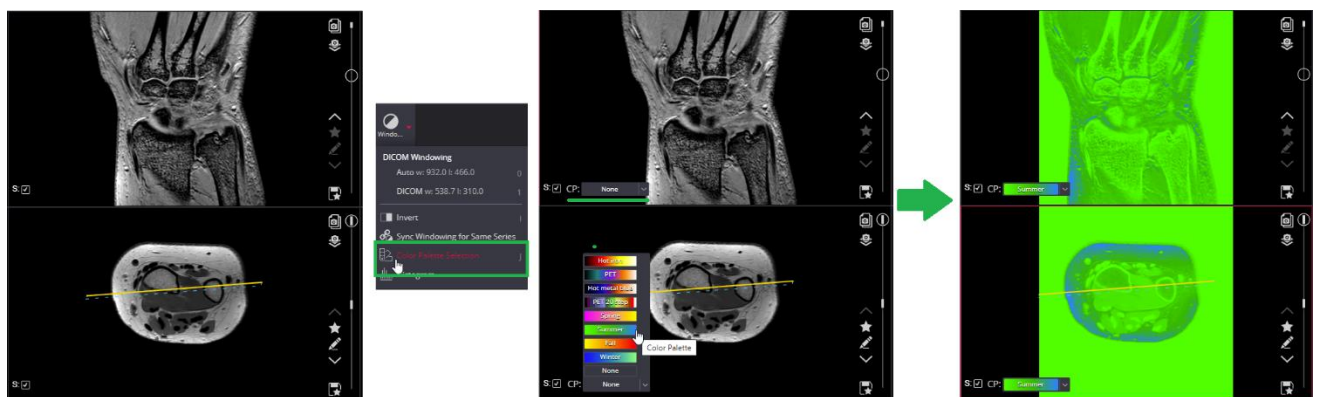

Figure 57. Sync CP in all viewports

NOTE! If the functionality is activated in different view states, e.g. Windowing has already been changed, or has already been moved, or has already been enlarged, or the viewport sizes are different, then the resulting visuals may be different because the action is performed in proportion to the current view state. It is not synchronized in absolute values.

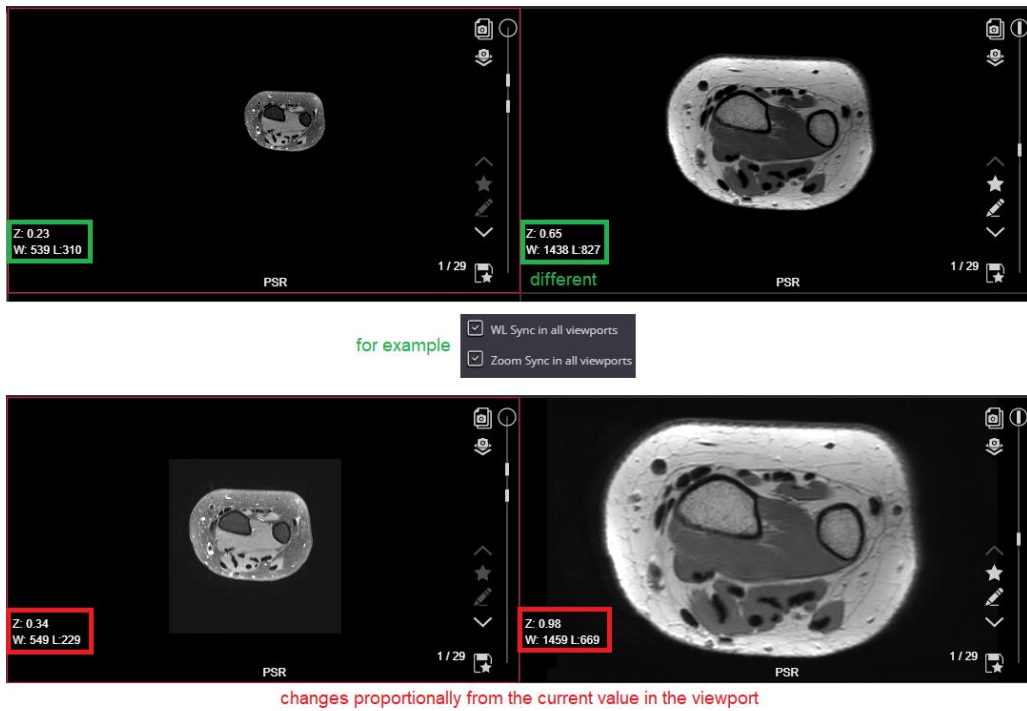

Figure 58. Proportional synchronization of actions

Layout and Multi image/series

Layout and **Multi image/series** functions allow dividing the view zone of the Viewer window for displaying the separate images in each division. It helps in analyzing and comparing the images.



Layout button divides the Viewers' view zone into viewports. Select the desired layout under the extendible **Layout** menu and the view zone will be divided in the selected number of identical size viewports. To change the viewports size, point the mouse cursor to division line (the cursor should obtain the divider look), hold the mouse button down and drag the line:

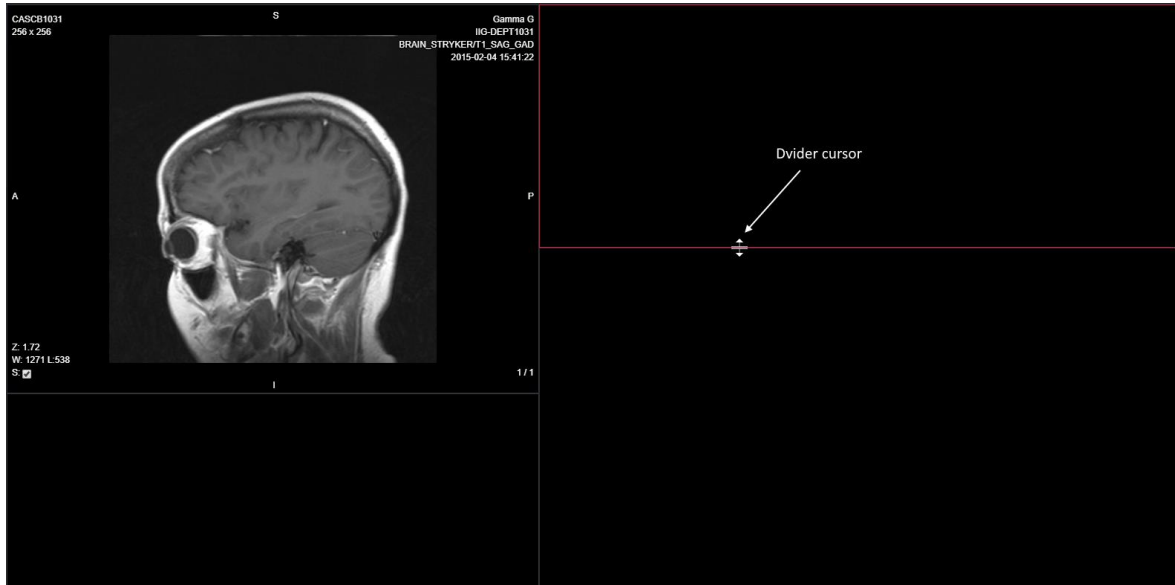
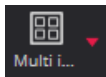

Figure 59. 2x2 layout view with manual viewports' size adjustment

NOTE! If the 2-panel setting is not activated, then double-click the left mouse button on the image for temporary viewing it on top of layout. Double-clicking the right mouse button on the enlarged image, returns to the previous layout. . If the 2-panel setting is activated, the image is enlarged only in one panel.

NOTE! The layout selection is saved in browser's local storage. If local storage does not contain the layout value, the layout is displayed according the system settings.



Select the menu from **Multi image/series** button drop down list to open the selected number of series images or series in the active viewport. The viewport is automatically divided to required number of sections. Each section has the same size and shows the separate image.

CAUTION! You cannot change the size of particular image that is opened as one of multi images. If the viewport size is changed, the size of multi images is automatically adjusted.

If any of the Multi image layouts is selected from the menu, the system applies the layout and opens the images of the current series in each section starting from the active image and following towards the end of the series. You can scroll the series in any of the multi image viewports using scroll bar or mouse. Opening the other image in the multi image viewport from the thumbnail bar automatically closes the multi image mode and opens the image in single viewport. Multi image or Multi series layout can also be closed manually by selecting the 1x1 Single image/series menu.

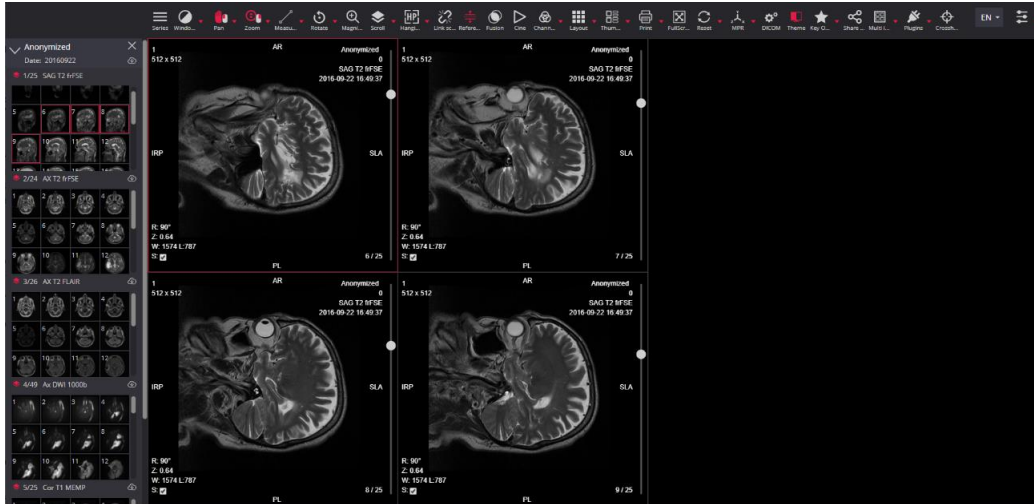

Figure 60. 2x2 Multi image menu applied in the first viewport of 1x2 layout

NOTE! Image manipulation functions (ex. **Scroll, Windowing, Rotate, Pan, Zoom**) affect the entire set of multi images that are opened in one viewport. For example, if you select **Bone** contrast mode for one of multi images, it will apply the **Bone** mode to all images that are viewed as multiple images in viewport though the changes do not apply to the image in other viewports.

If any of the Multi series layouts is selected from the menu, the system applies the layout and opens the first images of the different series in each section starting from the active series and following towards the end of the study. You can scroll the series in any of the multi series viewports using scroll bar or mouse, or open the other series from the thumbnail bar. You can quickly navigate through all the series of the study using shortcuts. By default, configuration, the **PageUp** shortcut opens the previous set of study's series, and the **PageDown** shortcut opens the next set of study's series in the multi series layout of the active viewport.

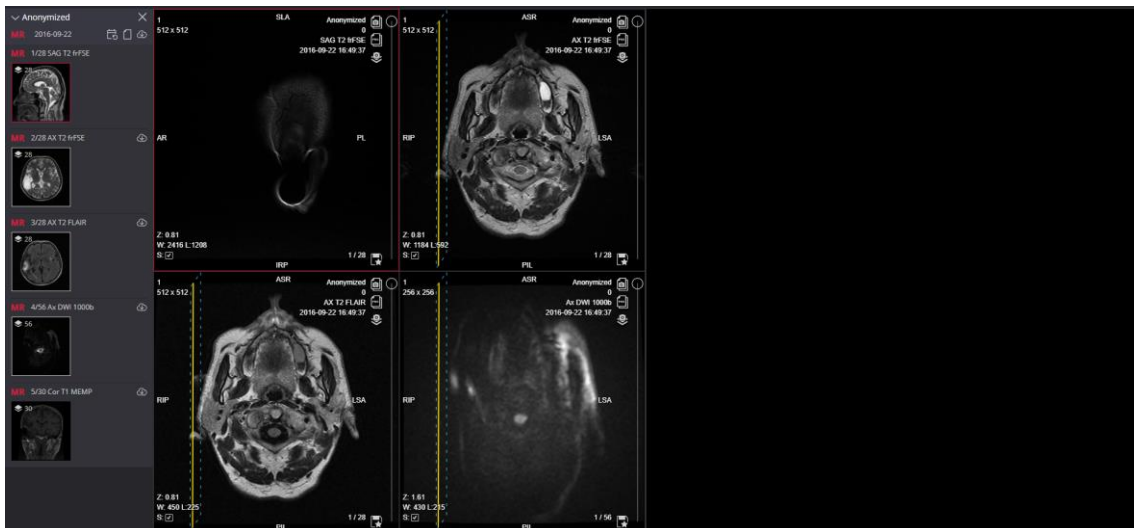



Figure 61. 2x2 Multi series menu applied in the first viewport of 1x2 layout

NOTE! If not more than two (2) Multi series layouts are opened in the viewer window, the **Alt+PageUp** and **Alt+PageDown** default shortcuts may be used for navigating through all the series of the study in the in the multi series layout of the other no active viewport.

Note, that default values of the shortcuts can be change. For more information see in chapter "Shortcuts".

Split layout

Provides the possibility to have two panels on one monitor, in which case a double-click on an open image will temporary enlarged inside one panel instead of the full viewport.

 **NOTE!** Feature must be activated in the settings.

When the user double-clicks on an open image, the image is temporarily enlarged inside one panel.

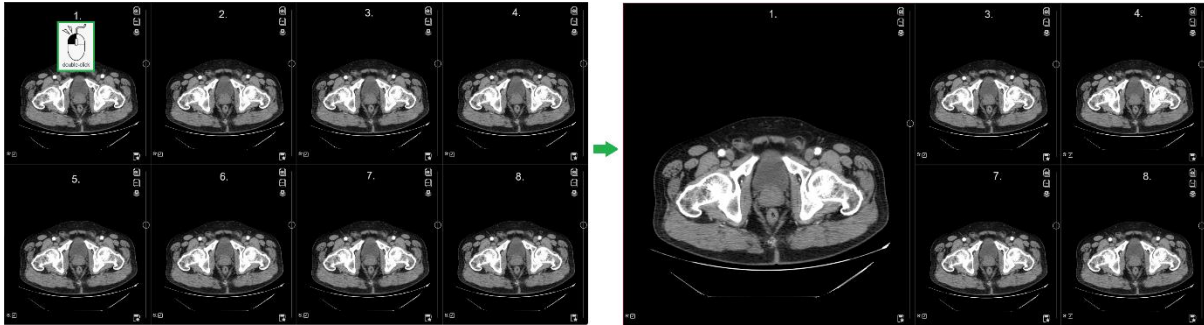

Figure 62. 2 panels. Enlarged inside one panel

Double-clicking on a zoomed image returns to the original layout.

When the user holds down Alt and double-clicks an open image, the image is temporarily enlarged in the opposite panel.

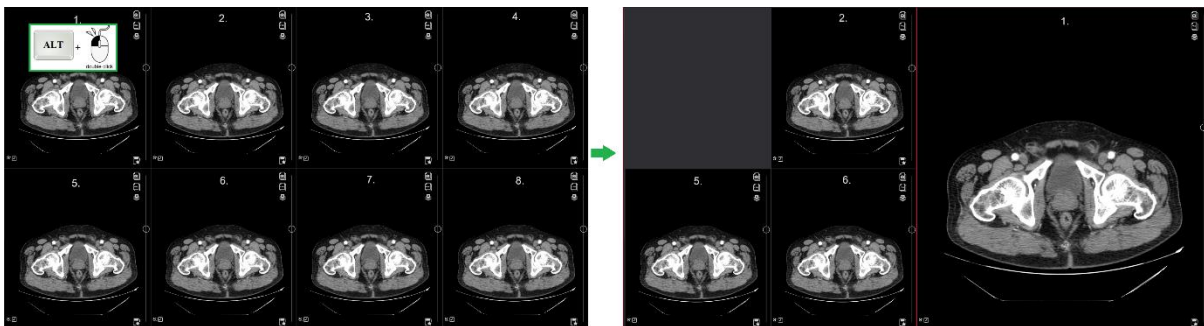

Figure 63. 2 panels. Enlarged in the opposite panel

Allows you to enlarge adjacent views in a single action by double-clicking on the edge of the viewport: by double-clicking on vertically or horizontally neighbouring viewport edges.

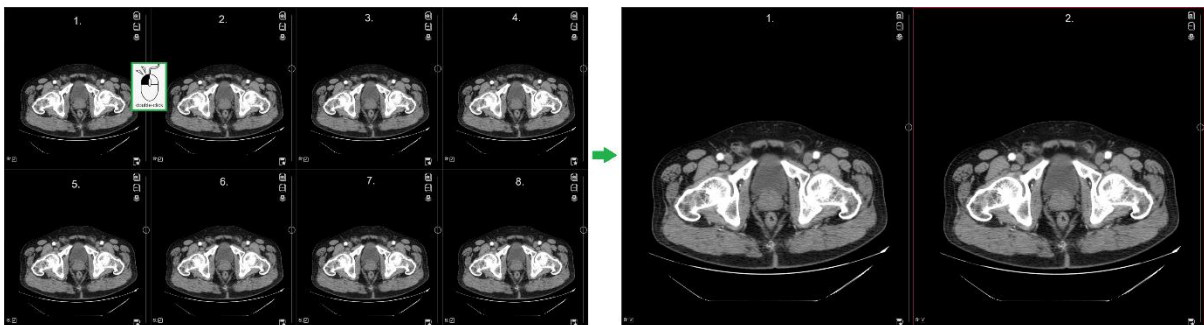

Figure 64. 2 panels. Enlarging two images. Side-by-side images

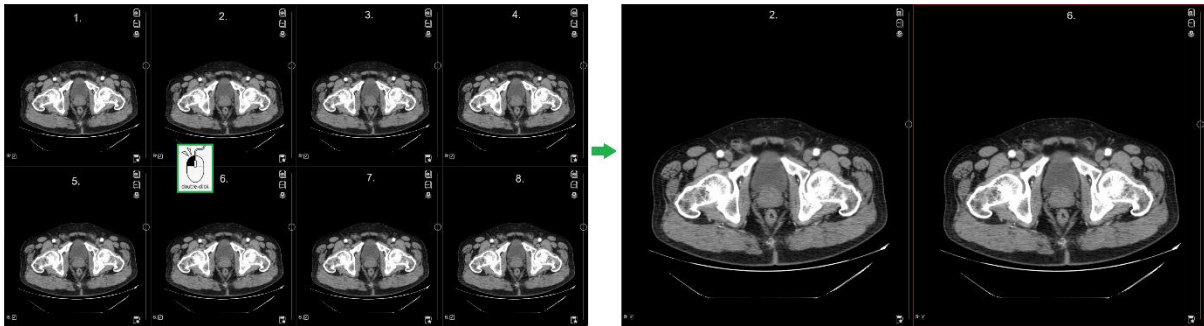

Figure 65. 2 panels. Enlarging two images. One image on top of another

Allows you to enlarge four images in one action: double-click on the corner connecting the four viewports.

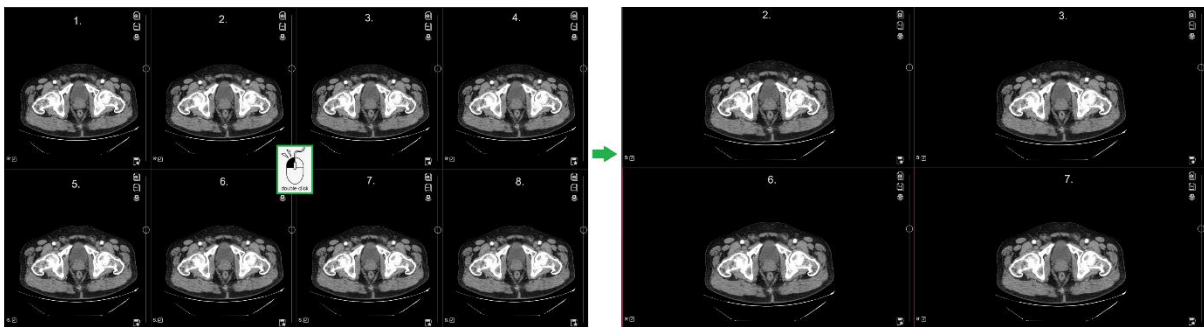

Figure 66. 2 panels. Enlarge four images

Double-clicking on any enlarged image returns you to the original layout.

With 2 panels and 1x1 layout, the performance is the same as with 1 panel, i.e. the image is magnified full viewport.

If the layout has an odd number of columns, e.g. 1X3, then the first two columns are mapped to the first panel and the third to the second.

NOTE! With 2-panel functionality enabled, it is no longer possible to manually resize the viewport by manually dragging the viewport edge.

NOTE! When working with two monitors, one panel on each monitor. Functionality not suitable for use with more than two monitors.

Reset

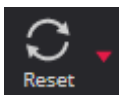

Reset button is used to reset the image, after using manipulations like **Windowing**, **Rotate**, **Pan**, **Zoom**, and clear measurements that you have been working on. You can choose to reset all images (**Reset All**), or to reset only active image (**Reset Selected**).

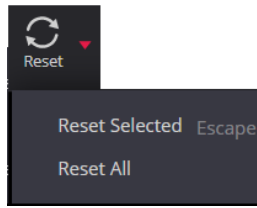

Figure 67. Reset button menu

Exception that **Reset** does not deactivate Align&Lock mode.

MPR



To start the multi-planar reconstruction, expand the **MPR** button menu and select the desired option in it:

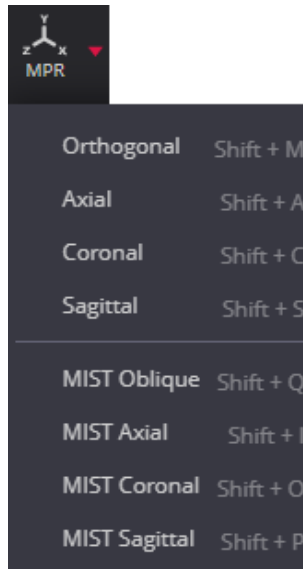
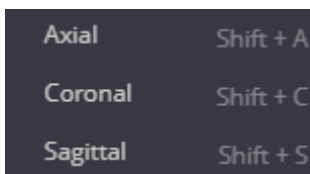

Figure 68. MPR button menu



NOTE! Multi-planar reconstruction (MPR) may be applied for CT, PT, NM and MR series having more than 2 images in series.

Axial, Coronal, or Sagittal



By selecting the corresponding menu option, you can launch the series image reconstruction in one of three planes: **Axial**, **Coronal**, or **Sagittal**. The program performs the following steps:

- Preloads the series images. The progress bar appears in the viewport during image preload process.
- Applies the required image transformation, if the selected plane differs from the original series data set. The transformation tag is displayed in the viewport, if applied.

- Displays the selected view (**Axial**, **Coronal**, or **Sagittal**) in active viewport. The scroll cursor is moved in the middle of the initial or calculated set of images.

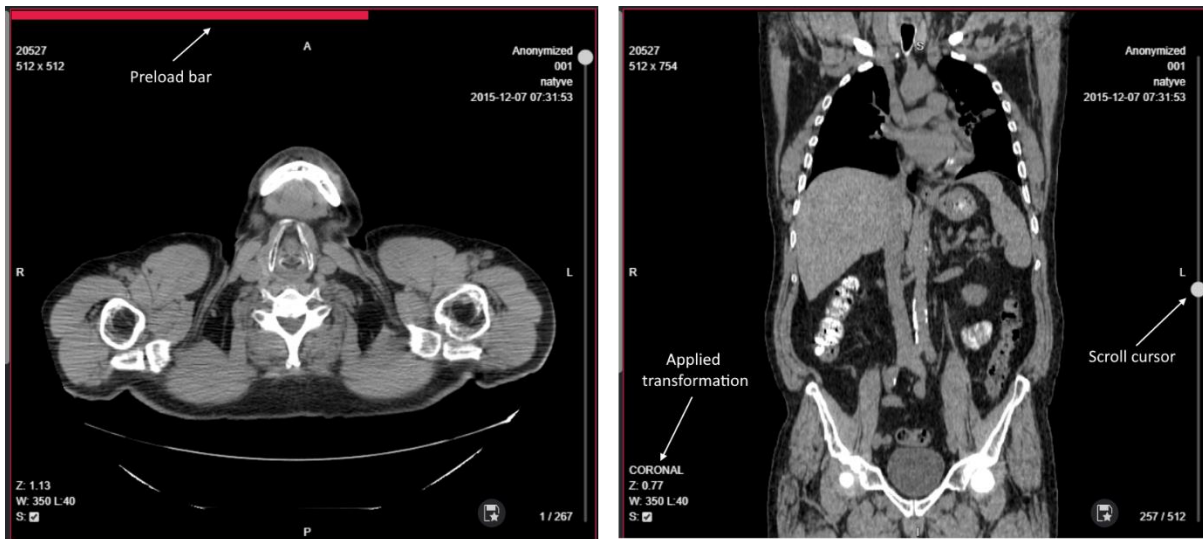
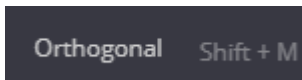

Figure 69. Steps of Coronal image reconstruction from axial series of images: axial series preload and calculated coronal view

Once the image reconstruction process is finished, you can use scroll bar or scroll function to see the images (slices) of the view (axial, sagittal, coronal) you have selected.

Orthogonal



Selecting the **Orthogonal** menu allows to get the series image reconstruction in two planes that are perpendicular to the original series plane. The program automatically applies the layout for displaying the original series and two reconstructed planes in separate viewports:



Figure 70. Orthogonal reconstruction from axial series of images

NOTE! To analyze images of the reconstructed series, use tools: **Windowing**, **Zoom**, **Pan**, **Scroll**, **Measure**, **Reference Lines**, **Crosshair**.

MIST Oblique

MIST Oblique Shift + Q

MIST Oblique is used for 3D reconstruction.

Images from one selected series are used for three-dimensional reconstruction. To perform a 3D reconstruction, load any image in the series into the selected viewport and press **MIST Oblique** from the **MPR** drop-down menu. The system divides the viewing area into four parts and starts the loading of the series of images and the image reconstruction process.

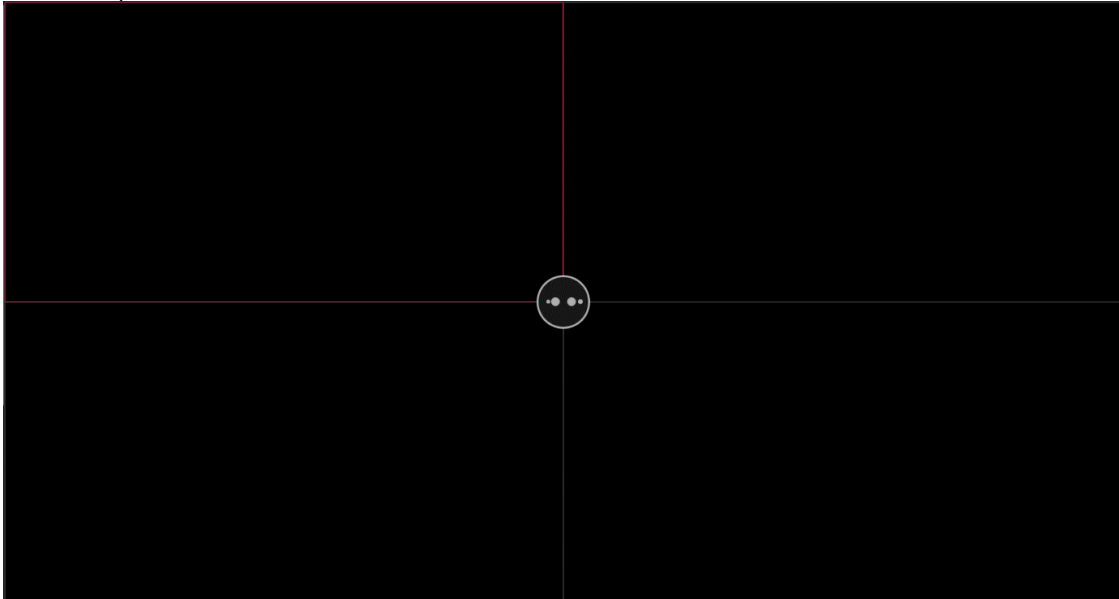

Figure 71. MPR MIST Oblique 3D indicator of the reconstruction process

The image data of the original series is converted to a spatial image. After the reconstruction process, parts of the viewport display the 3D image and slices of the transformed images in three perpendicular planes.

NOTE! Mozilla Firefox browser has certain memory limitations: MIST MPR functionality will fail on series where uncompressed DICOM data is larger than 2 GB.

NOTE! The system can be set to not generate a 3D image. In the case of such a system configuration, only sections of the transformed images in three perpendicular planes are visible in the result.

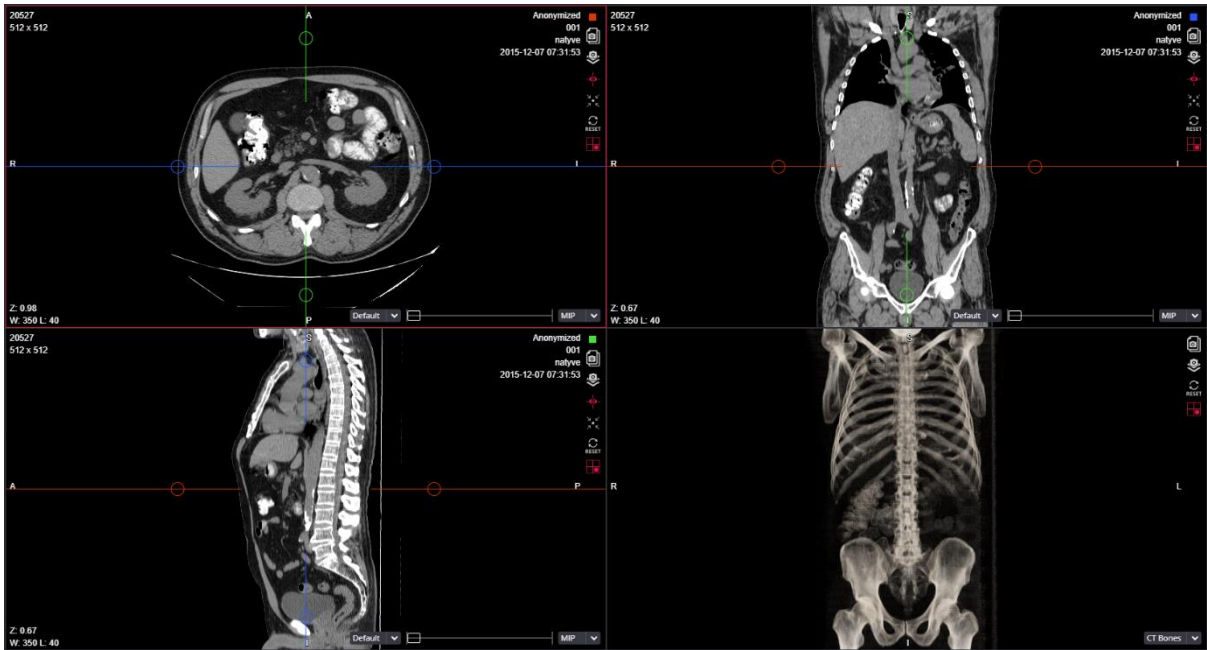

Figure 72. The reconstruction result of MPR MIST Oblique

Series of transformed images are displayed in the main anatomical planes: axial, coronal and sagittal.

- The first viewport (first row left column) shows a series of transformed images in the axial plane. The axial plane is indicated by a red square in the upper right corner of the viewport.
- The second viewport (first row right column) shows a series of transformed images in the coronal plane. The coronal plane is indicated by the blue square in the upper right corner of the viewport.
- The third viewport (first row right column) shows a series of transformed images in the sagittal plane. The sagittal plane is indicated by the green square in the upper right corner of the viewport.

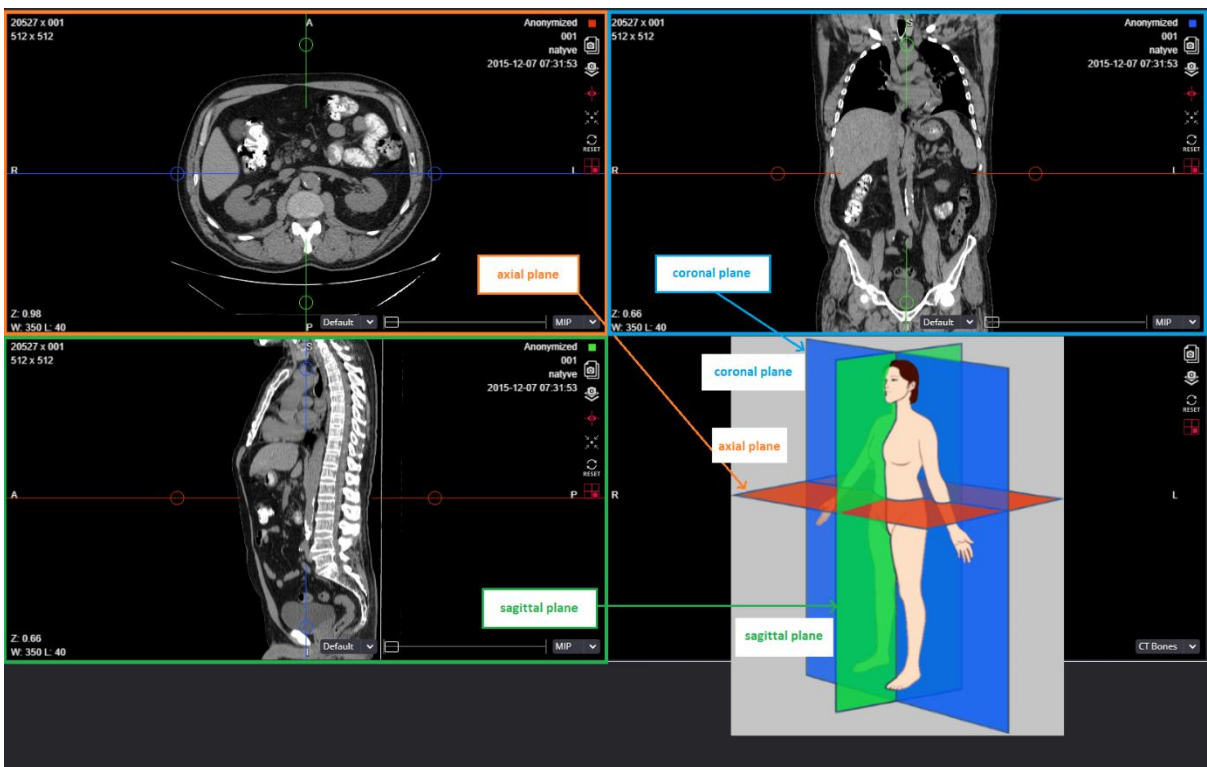

Figure 73. The Scheme of planes of transformed images

The anatomical direction of the transformed images in the viewing area is from left to right and from top to bottom:

- axial plane series images are displayed in the direction from R (left) to L (right) and from A (top) to P (bottom);
- coronal plane serial images are displayed in the direction from R (left) to L (right) and from S (top) to I (bottom);
- the sagittal plane serial images are shown in the direction from A (left) to P (right) and from S (top) to I (bottom).

The lower right corner of each plane image shows the thickness of the slice used for image preparation in millimeters and the method of image preparation.



Figure 74. The thickness of the section used for image preparation in millimeters and the method of image preparation

Slice thickness **Default** by default is 0.01 mm.

The slice thickness can be changed:

- selecting the thickness value from the list;
- by moving the cursor in the scroll bar

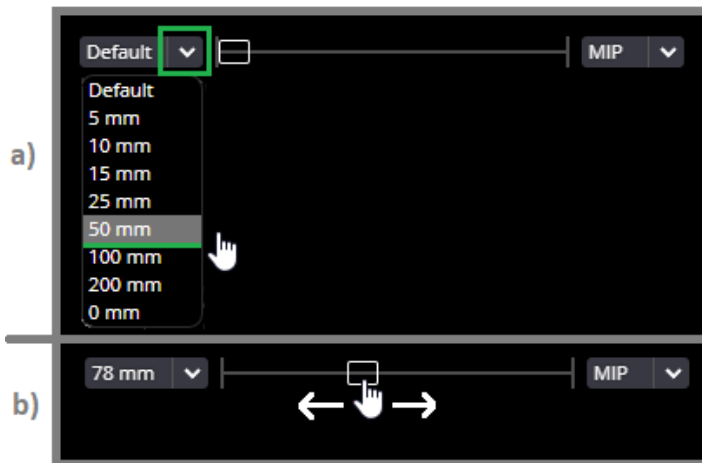

Figure 75. Changing the slice thickness

The image preparation method can be changed by selecting a value from the drop-down list.

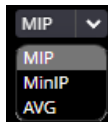

Figure 76. Changing the image preparation method

The values:

- **MIP** (Maximum Intensity Projection): the pixel of the generated image is assigned the maximum value from the images (layers) entering the section;
- **AVG** (Average Intensity Projection): the pixel of the generated image is assigned an average value calculated from the images (layers) entering the section;
- **MiniIP** (Minimum Intensity Projection): the pixel of the generated image is assigned the smallest value from the images (layers) entering the slice.

Actions with transformed images

To rotate the intersecting planes:

- place the mouse cursor on any axis rotation element - a circle,
- press the left mouse button
- while holding the button down, rotate the axis around the center point.



Figure 77. Rotation of intersecting planes

NOTE! When the user rotates the intersecting planes in one of the transformed image slices, the system rotates the other two slice images.

NOTE! As the plane is rotated, the system automatically updates the anatomical direction indicators displayed in the view areas of the rotated planes, which can be used to judge the direction of the cut in the patient's body.

To scroll along the intersecting planes:

- place the mouse cursor on the axis line in the selected section view;
- press the left mouse button,
- scroll the axis while holding the button down.

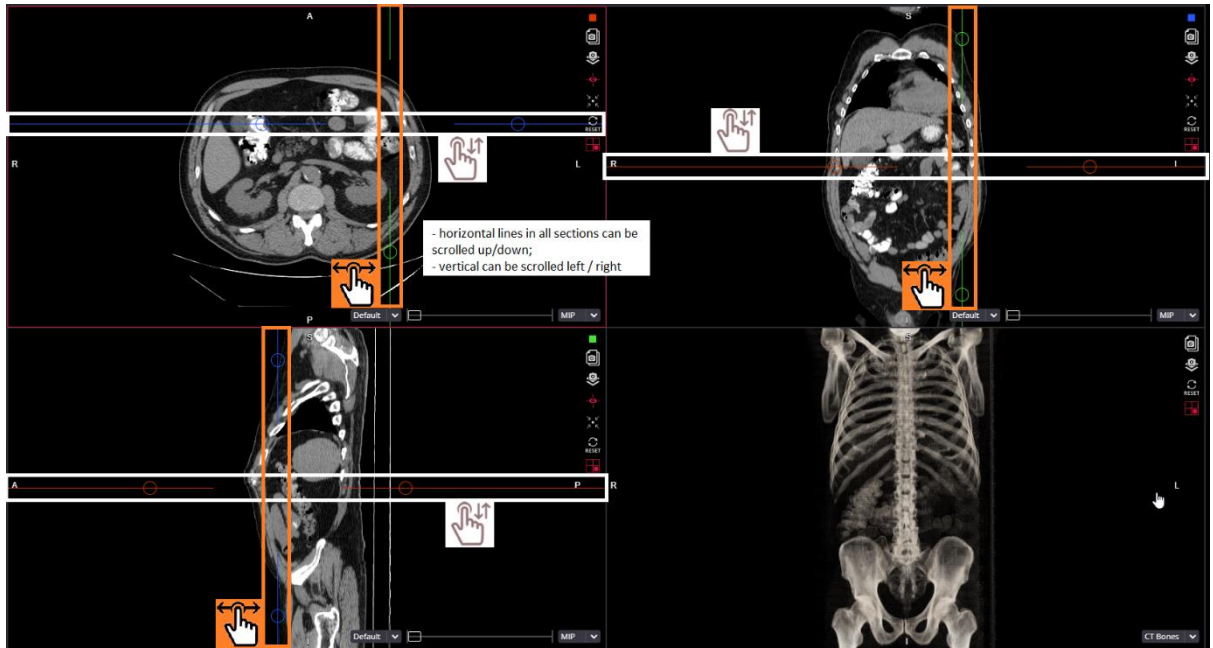

Figure 78. Longitudinal displacement of intersecting planes

NOTE! As the user longitudinally scrolls the intersecting planes in one of the transformed image slices, the system scrolls the images in the other two planes.

NOTE! The action can be performed after the axes have been rotated. Then you don't scroll up/down or left / right, but diagonally, depending on how the rotation was done.

Carry intersecting planes:

- place the mouse cursor on the intersection center of the axis lines in the selected section view;

NOTE! The center of intersection of the axes is not visible. Move the mouse out of the eye to estimate where the center point might be. If the exact center is not hit, the system moves the intersecting planes so that the center is where the mouse was clicked.

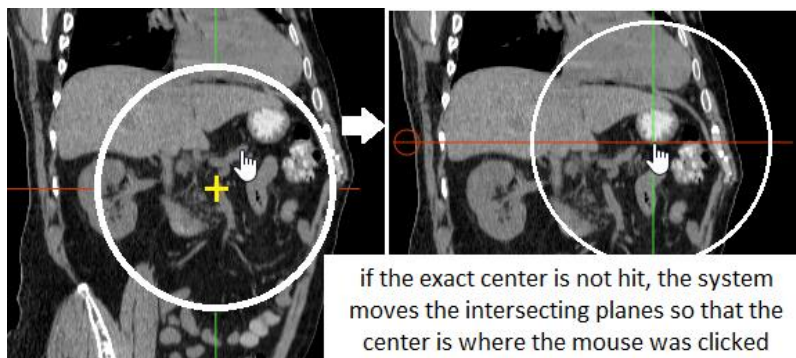

Figure 79. The center point of the intersecting planes

- press the left mouse button,

- the system redraws the axes so that the point of intersection is visible,
- hold down the button and drag the intersecting planes in any direction.

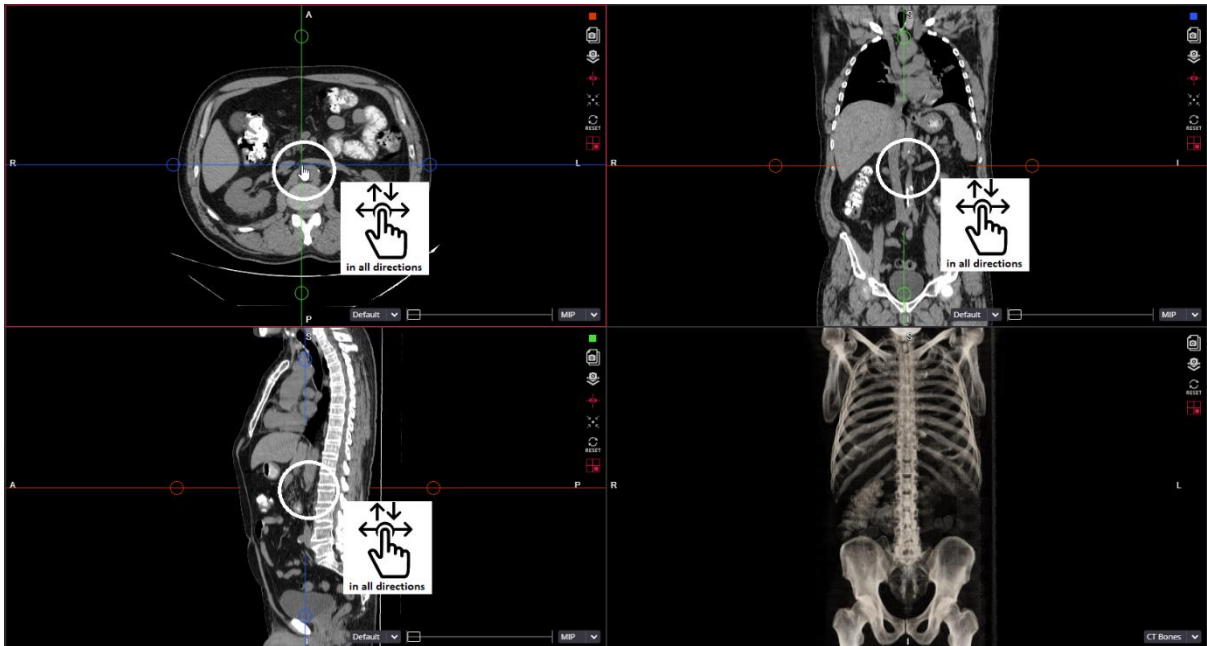

Figure 80. To carry the intersecting planes

NOTE! As the user moves the intersecting planes in one of the slices of the transformed images, the system scrolls the images in the other two planes.

Actions can be performed by selecting an action button in the viewport.

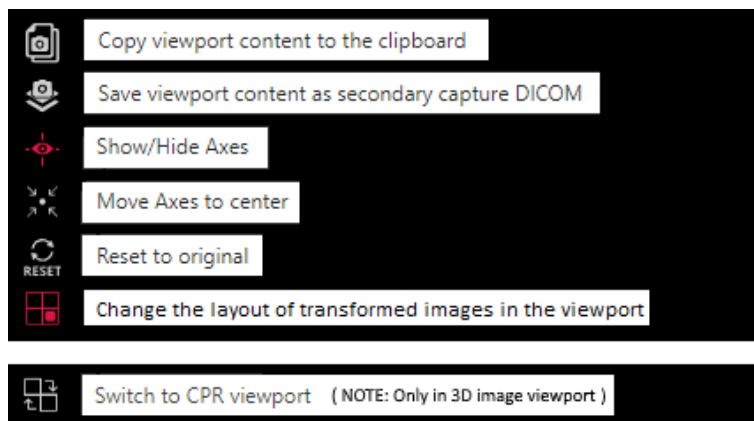





Figure 81. Action buttons in the viewport

The action  converts the content of the viewport to png format and copies it to the clipboard. After copying, the clipboard image can be pasted into any resource that supports the png format.

The action  converts the copied content of the viewport to a DICOM sub-input file and saves it to the PACS.

For a detailed description of actions  and , see in section “Copy viewport content”.

Show/hide axes. To hide the axes of transformed images, select . After the action, the button icon will change to white .

If the axes are not visible, selecting  makes the axes visible.

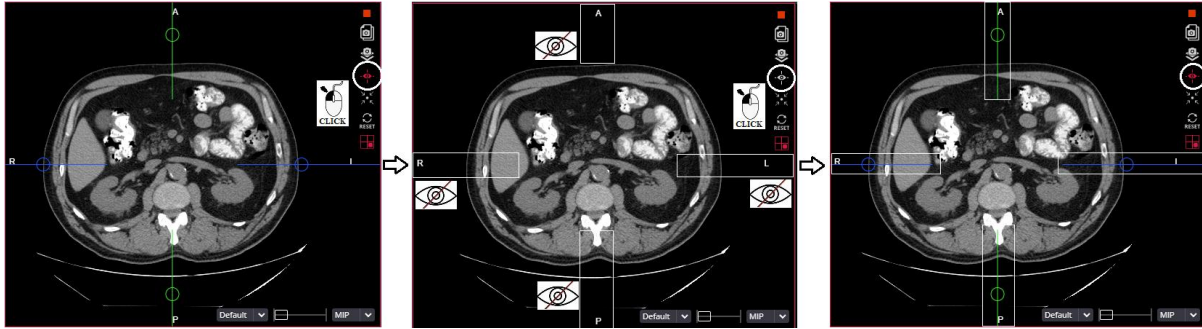





Figure 82. Show/hide axes

 **NOTE!** There is no action in the transformed spatial 3D view.

 **NOTE!** Selecting an action on any axial slice plane of the transformed image shows or hides the axes in all three planes: axial, coronal, and sagittal.

To center the axes. To see the transformed axial sections centered, to see the axial lines passing through the centers of the images, select .

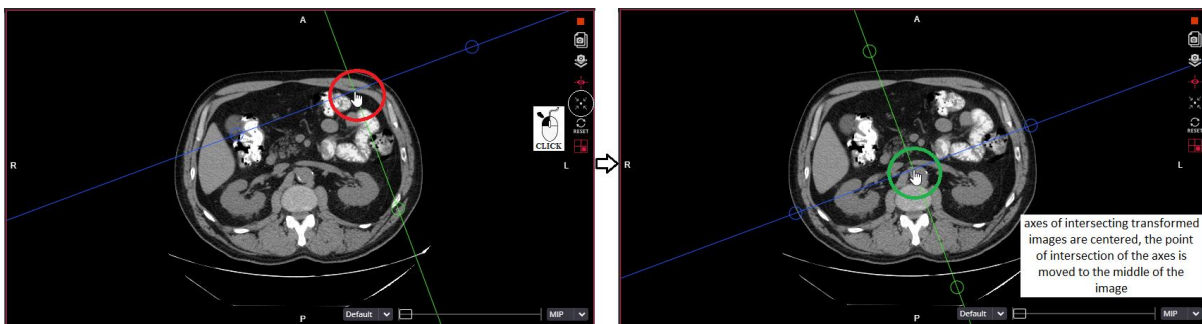





Figure 83. To center Axis

 **NOTE!** There is no action in the transformed spatial 3D view.

 **NOTE!** Selecting an action on any axial slice plane of the transformed image centers the axes in all three planes: axial, coronal, and sagittal.

 **NOTE!** If the axes of the transformed images have been rotated, the Center Axis action does not restore the rotation.

Restore the original image. After completing the actions with the axial sections of the transformed images, select . The system will reset the images to their original state.

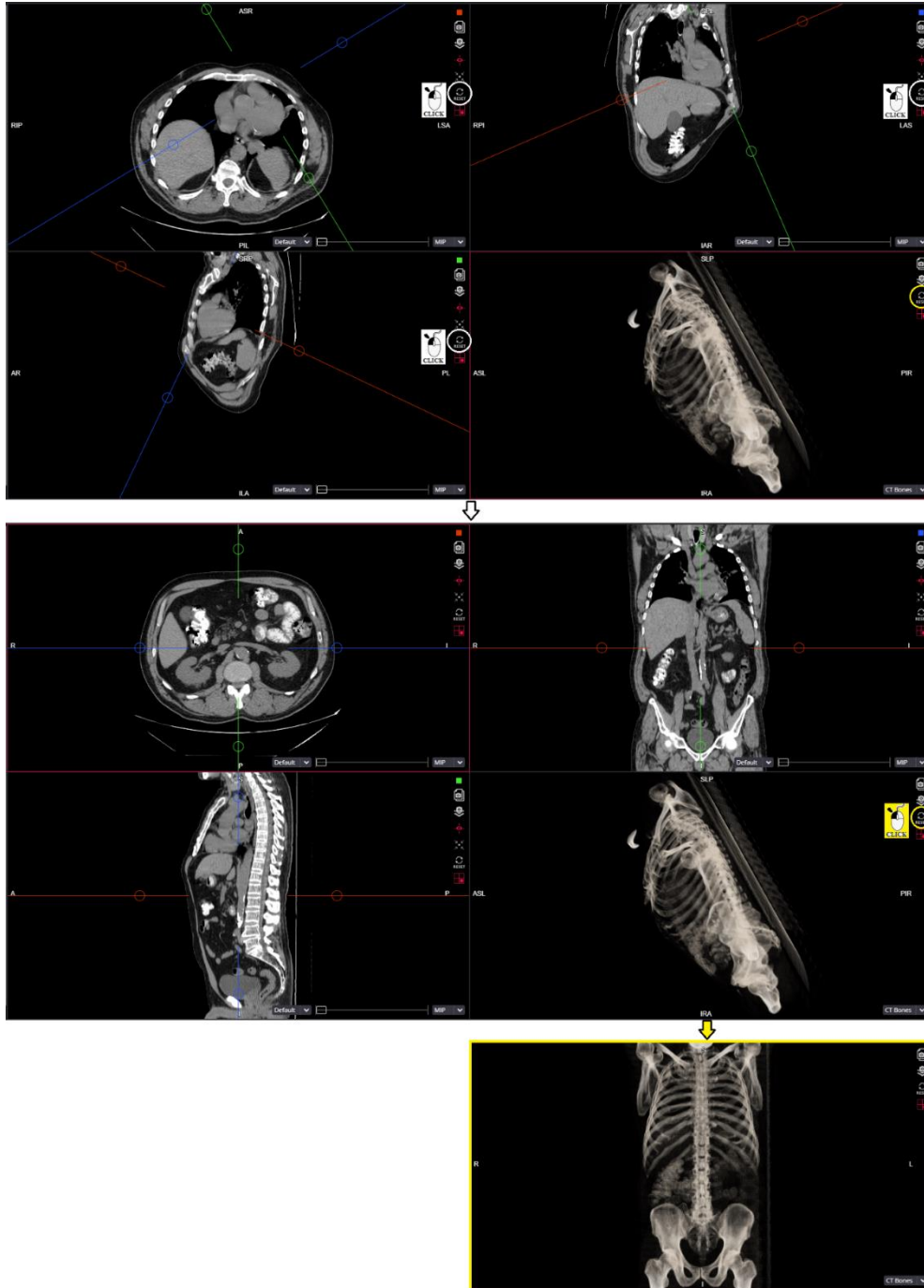





Figure 84. Action of restoring the original image



 **NOTE!** Selecting an action in any axial slice plane of the transformed image restores images in all three planes: axial, coronal, and sagittal.

 **NOTE!** Action  is also in the transformed spatial 3D image viewer. This action button works separately from the axial section view buttons.





To **Change the layout of transformed images in the viewport**, press . The system displays a list of possible image layout values.





Figure 85. The list of values for the layout of transformed images

 **NOTE!** After changing the layout of the images, the icon of the action button  changes to the icon of the selected layout, e.g. .

The layout  is applied when opening the transformed image. The **MIST Oblique** layout divides the field of view into four equal sections, three showing axial, coronal, and sagittal sections, and the fourth a three-dimensional view.

Layouts    represent axial, coronal, and sagittal sections, do not represent a three-dimensional image. The order of arrangement of axial sections can be changed by selecting .

The layout  shows axial, coronal and sagittal slices, in the right part of the MIST viewing window shows a three-dimensional view.

When selected , only the 3D spatial image is displayed. Axial views of the sections are not depicted.

When selected , the active image is magnified over the entire **MIST Oblique** viewport.

To **Switch to Curved Planar Reconstruction (CPR) viewport**, press  in 3D image viewport. The system converts the 3D viewport to 2D CPR viewport and displays the controls for enabling the curved planar reconstruction:

- Click the CPR line tool to activate it, the icon is highlighted .
- Draw the polyline for the plane you want to be straightened:
 - position the mouse pointer on the point from which you want to start, click and release the left mouse button;

- then move the cursor to the second, third, fourth, etc. points and each time click the left mouse button once and release it;
- when the cursor is moved to the last point, double click the left mouse button.
- The system straightens the curved plane and displays the reconstructed 2D view in CPR viewport.

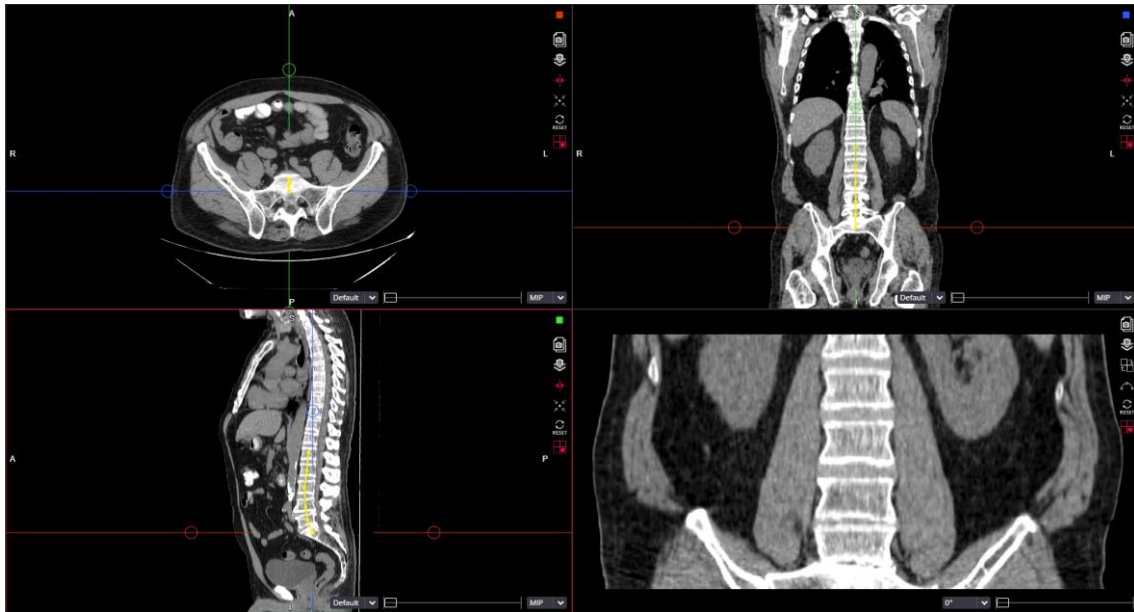

Figure 86. Curved plane reconstruction

- You can move the polyline points or the whole line in any of the 2D viewports to adjust the curved plane view.
- You can use rotation slider or rotation angle expandable list to rotate the reconstructed curved plane around the axis (straightened polyline).

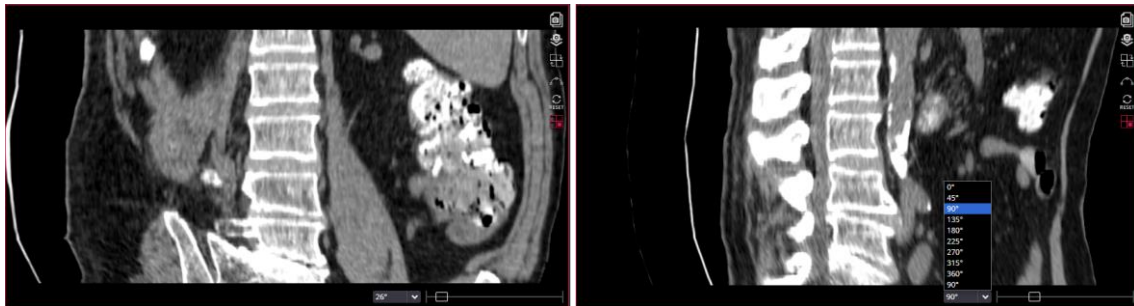





Figure 87. Reconstructed curved plane rotation using slider or angles list

When you have finished working with CPR, press  to return to 3D image viewport.

Implemented the possibility to perform actions with transformed series of images and with formed spatial image, **the buttons of which are available in the menu bar**: to change Windowing level, to move, to zoom in, to rotate, etc.

 **NOTE!** The actions that are selected in the menu bar are different when one of the slice views and the 3D

view are active. Actions **Measure**  and **Fusion**  can only be performed in axial, coronal and sagittal planes.

NOTE! The menu is controlled by the system settings, so the use of some functions may be restricted, the menu buttons may be unavailable.

Rotate  transformed image planes and 3D images in all directions. The system does not update other planes when rotating.

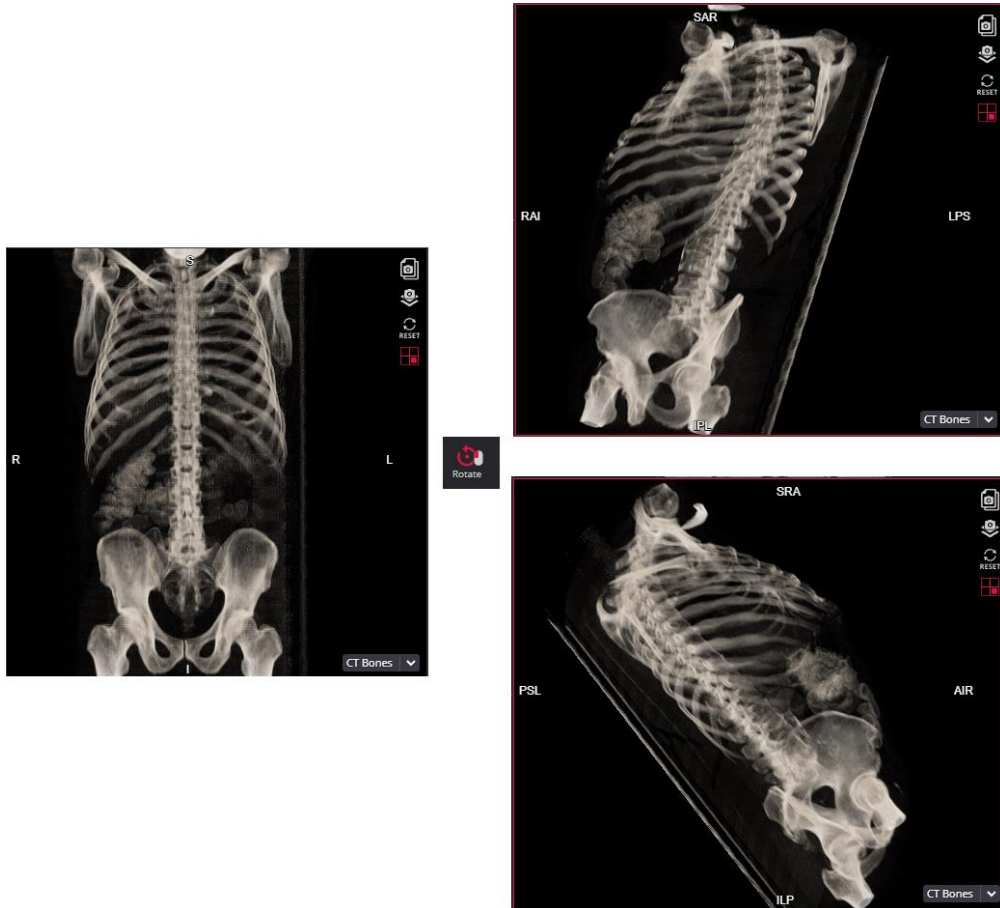
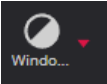

Figure 88. Rotation of the spatial image

In the axial, coronal and sagittal planes, the Rotate action menu additionally allows the selection of the **Flip Horizontal** and **Flip Vertical** functions.

It is possible to change the Windowing level by selecting an action  in the menu. It is described in detail in the “Windowing” section.

In the lower right corner of the spatial 3D image viewing window, it is possible to select programmed Windowing level presets.



Figure 89. Selection of expected Windowing levels in a spatial 3D image

NOTE! After selecting default 3D Windowing levels, the default values can be adjusted by selecting an  action.

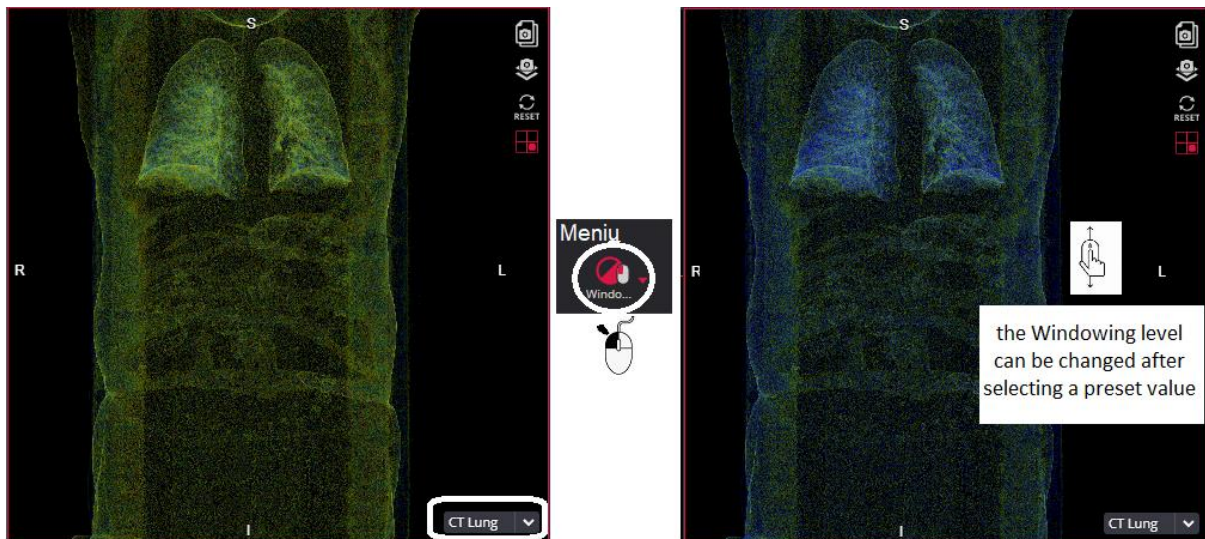

Figure 90. Changing the Windowing level after selecting the default value

After performing operations on transformed images, it is possible to switch to another viewing area of the application window, change the layout of the application window, create additional viewing areas, open images of the same study or another study in them and perform the desired actions on them, including transformation of images of another primary series MIST Oblique in another viewport.

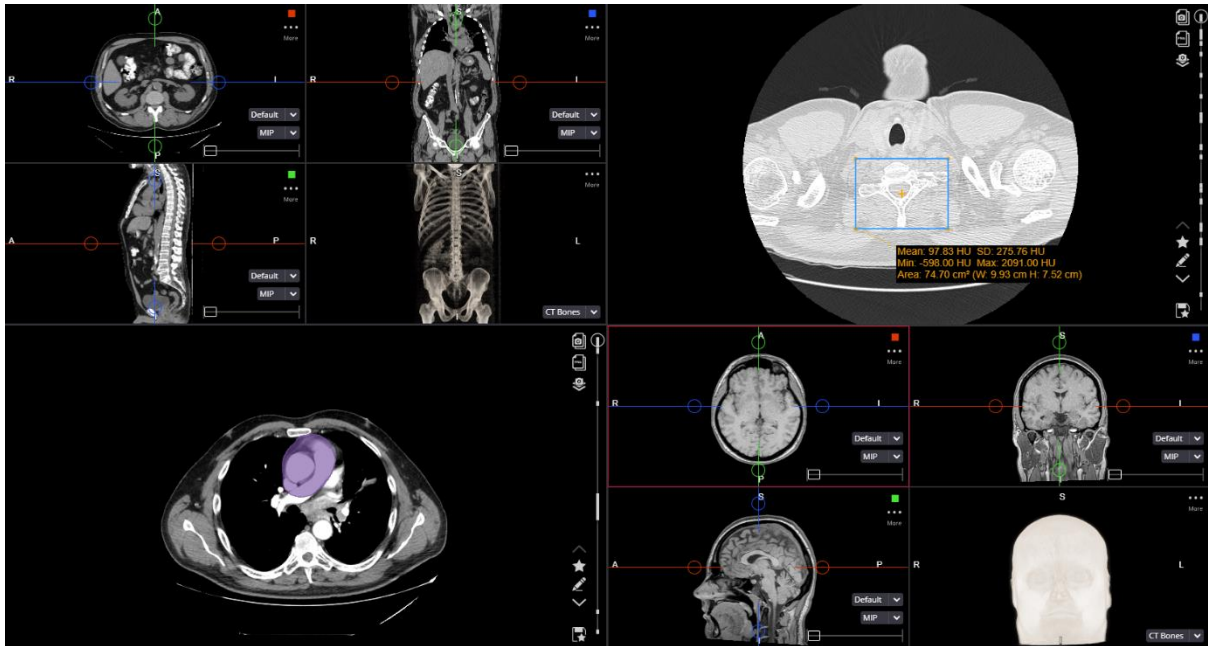

Figure 91. Additional Areas of Review

NOTE! Menu actions not described in this section work the same as opening an untransformed image in the viewport. Detailed descriptions of the actions in other sections of the document.

The reconstruction action **MIST Oblique** can be initiated with shortcut. By system value by default, the shortcut is Shift + Q.

This value of shortcut can be change. For more information see in chapter "Shortcuts".

MIST Axial, MIST Coronal, MIST Sagittal

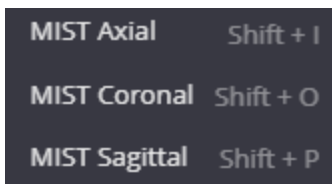

By selecting the corresponding menu option, you can launch the series image reconstruction in one of three planes: **MIST Axial**, **MIST Coronal**, or **MIST Sagittal**. The program performs the following steps:

- Preloads the series images. The progress bar appears in the viewport during image preload process.
- Applies the required image transformation, if the selected plane differs from the original series data set. The transformation tag is displayed in the viewport, if applied.
- Displays the selected view (**Axial**, **Coronal**, or **Sagittal**) in active viewport. The scroll cursor is moved in the middle of the initial or calculated set of images.

NOTE! Mozilla Firefox browser has certain memory limitations: MIST MPR functionality will fail on series where uncompressed DICOM data is larger than 2 GB.

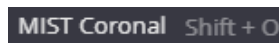
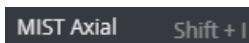



Figure 92. MIST axial, MIST coronal, MIST sagittal

The reconstruction action can be initiated with shortcuts. By system value by default, the shortcuts are:

- MIST Axial – Shift + I
- MIST Coronal – Shift + O
- MIST Sagittal – Shift + P

These values of shortcuts can be change. For more information see in chapter "Shortcuts".

The functionalities on transformed images are same that on MIST Oblique. See the section above.

Reference Line and Crosshair

Reference Line and **Crosshair** tools helps to localize the images in intersecting planes.



NOTE! The localization tools are mainly used for CT, MR and PT studies, that contains several series taken in several planes.

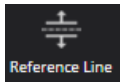

Overlaying reference lines allow you to indicate the location of an image slice on another image of an intersecting plane:

- Prepare Layout for image comparison. Move into viewports the images that you want to compare.
- Activate viewport with the image you want to know the location of in regard to other images.
- Click the button Reference Line. The button highlights  that indicates activation of reference line function in all the opened viewports.
- Yellow lines, indicating the location of the active image, appear in the images that are in the planes intersecting with an active image plane:

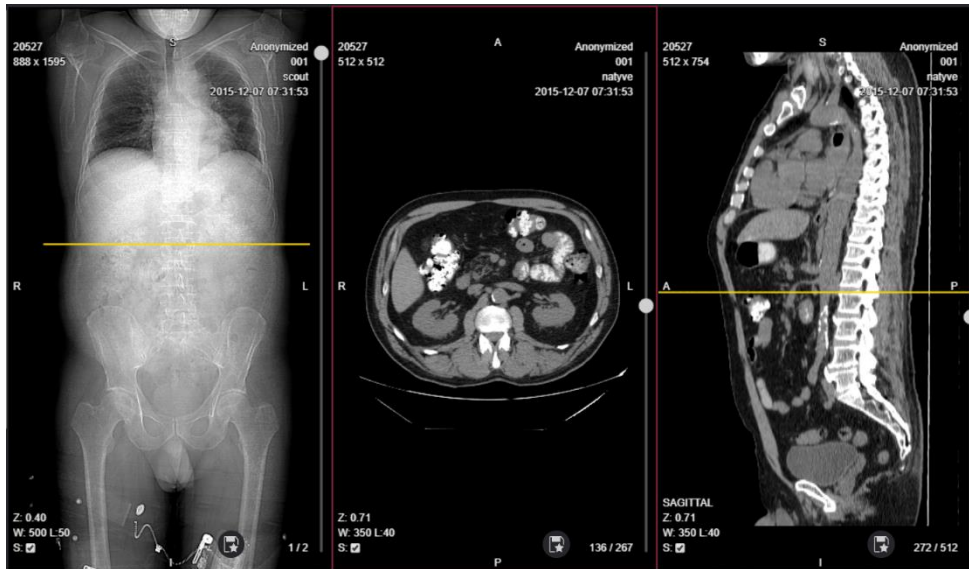

Figure 93. Image reference line in intersecting planes

- Scroll the active image series to see the reference line moving in intersecting planes.

NOTE! Reference line function is automatically applied in all active viewports if **Reference line** tool is activated (tool icon is highlighted). If the function is not needed, click the highlighted **Reference line** button to deactivate the tool.

The dashed rectangle near the reference line indicates the slope of intersecting plane in case the image plane and intersecting plane is not orthogonal:

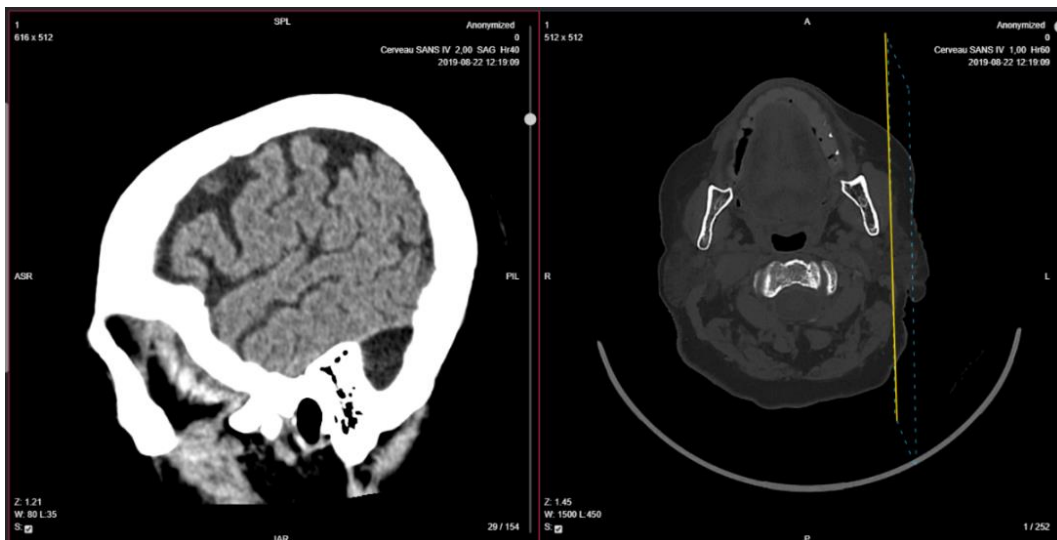



Figure 94. Not orthogonal intersecting plane view



Crosshair tool allow you to locate the images (slices) of the intersecting planes for the selected point on the active image:

- Prepare Layout for image comparison. Select the images from series that you are interested in and move them into viewports. You can also use the MPR function to generate the wanted axial reconstruction from the series.

- Activate the crosshair function by assigning the wanted mouse button . Hover over the point of interest for the image being analyzed and click the selected mouse button.
- The system automatically displays the intersection lines and locates the corresponding images (slices) in the viewports displaying series from intersecting planes. The intersection plane and plane's intersection line are marked with the same color (red, green or blue).

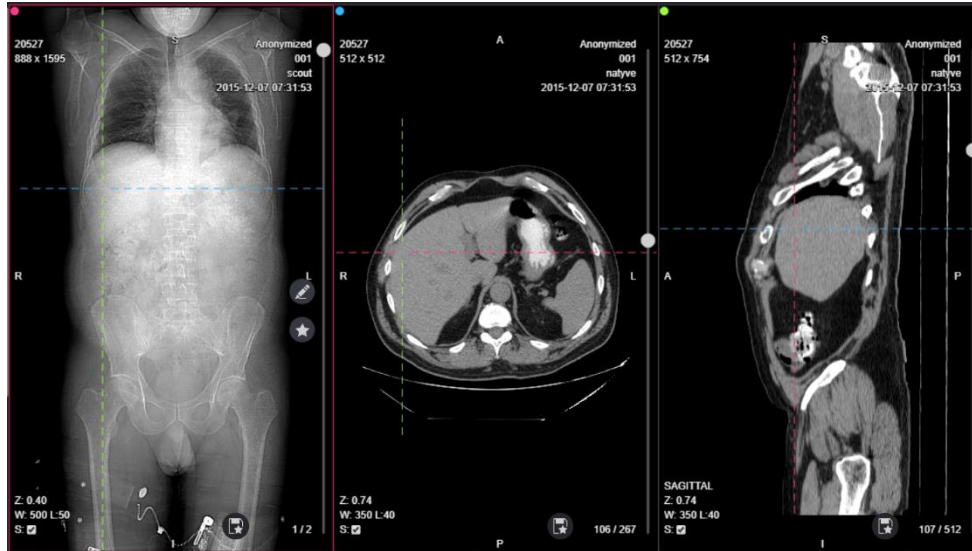



Figure 95. Crosshair tool

- Hold the mouse button pressed and drag the crosshair through the image to see the slices changing in intersecting planes.

 **NOTE!** In Oblique views, you can rotate the crosshair by holding the mouse button pressed and dragging one of the lines.

Rotate



Rotate button allows you to rotate and flip the image. You can rotate the image using the mouse or rotate option from menu.

To rotate the image with mouse, assign the mouse button to Rotate function . To rotate the image, hold the selected mouse button pressed on the any side of the image and drag it clockwise or counterclockwise wise. The rotation angle is displayed on the bottom left corner and changes when the image is rotated.

Use the **Rotate** button menu to rotate or flip the image:

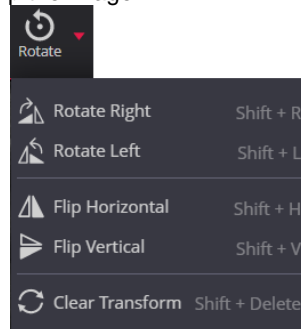

Figure 96. Rotate button menu

- **Rotate Right** – to rotate the image 90° clockwise.
- **Rotate Left** – to rotate the image 90° counter-clockwise.
- **Flip Horizontal** – to flip an image 180° about the horizontal axis.
- **Flip Vertical** – to flip an image 180° about the vertical axis.
- **Clear Transform** – revert to original image orientation.

DICOM



Click **DICOM** button to open the modal with DICOM tags of the active image:

Tag	Type	Value	Name
(0002,0001)	OB	binary data size 2	File Meta Information Version
(0002,0002)	UI	1.2.840.10008.5.1.4.1.1.4	Media Storage SOP Class UID
(0002,0003)	UI	1.2.826.0.1.3680043.8.1055.1.20160922221651448.622407897.1078374	Media Storage SOP Instance UID
(0002,0010)	UI	1.2.840.10008.1.2	Transfer Syntax UID
(0002,0012)	UI	1.2.40.0.13.1.3	Implementation Class UID
(0002,0013)	SH	dcm4che-5.10.6	Implementation Version Name
(0008,0005)	CS	ISO_IR 100	Specific Character Set
(0008,0008)	CS	ORIGINAL, PRIMARY, OTHER	Image Type
(0008,0016)	UI	1.2.840.10008.5.1.4.1.1.4	SOP Class UID
(0008,0018)	UI	1.2.826.0.1.3680043.8.1055.1.20160922221651448.622407897.1078374	SOP Instance UID
(0008,0020)	DA	20160922	Study Date

Figure 97. DICOM tag window

You can search the DICOM tag by selecting the appropriate criteria entry field and entering the text in it. Search according to **Tag**, **Value**, **Type**, and **Name** parameters can be done. The system filters the data automatically at the text entry:

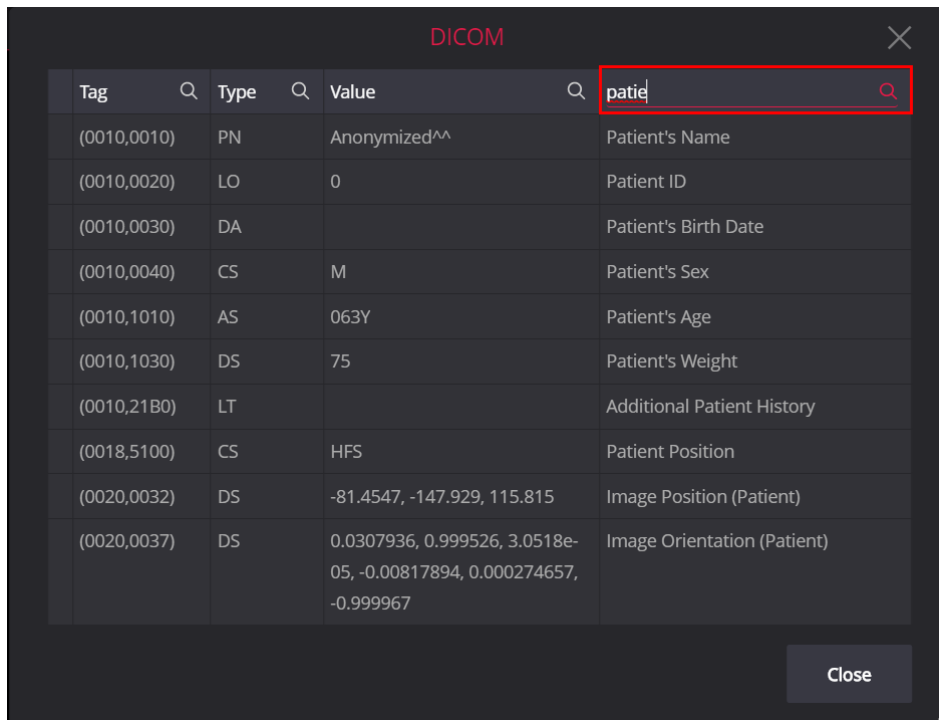

Figure 98. Search according DICOM tag name in DICOM tag window

'+' sign on the left of SQ tags indicates the container tag, that holds the other tags. Click the '+' sign to expanded the list and see the internal tags:

(0038,0010)	LO	Urgent	Admission ID
- (0040,0555)	SQ		Acquisition Context Sequence
(0040,A040)	CS	CODE	Value Type
- (0040,A043)	SQ		Concept Name Code Sequence
(0008,0100)	SH	5.4.5-33-1	Code Value
(0008,0102)	SH	SCPECG	Coding Scheme Designator
(0008,0103)	SH	1.3	Coding Scheme Version
(0008,0104)	LO	Electrode Placement	Code Meaning
+ (0040,A168)	SQ		Concept Code Sequence
+ (0040,B020)	SQ		Waveform Annotation Sequence

Figure 99. Expanding the SQ tags in DICOM tag window

Link scrolled series



Link scrolled series button is intended for making comparison on image slice location. Linking may be applied to currently viewed series with more than one image in series. There are three types of this button: **Disabled**, **Manual**, and **Automatic**.



Disabled mode indicates, that scroll is not synchronized.



In the Manual mode, the active series and all the other series having multiple images are linked for scrolling. System displays manual series link button in the top right corner of the viewport and switches scrolling on for all series by default.



In the **Automatic** mode, the active CT or MR series and all the other series with identical modality, frame of reference UID, and image orientation (patient) values and having multiple images are linked for scrolling. System displays automatic series link button in the top right corner of the viewport and switches scrolling on for all series by default.



In the distance mode, the active series and all the other series of the same anatomical axis and having data for calculating the slice distance from the referenced position are linked for scrolling. System displays distance series link button in the top right corner of the viewport and switches scrolling on for all series by default. The currently opened instance in all linked series is treated as the same body place and reference position.



NOTE! To change the reference position for the series, disable the distance link in the viewport, scroll to the corresponding image, and then enable the distance link.

By default, Viewer window opens with Link scrolled series mode set to **Disabled**, and you should change it manually by clicking the button. The icon is changed to the Manual mode, Automatic mode, distance mode, and back to Disabled mode correspondingly.

You can change the default Link scrolled series mode to Automatic with in **Link scrolled series** button menu:

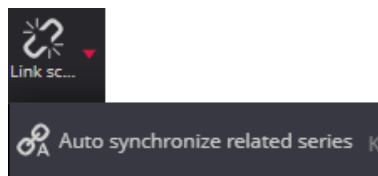



Figure 100. Link scrolled series button menu

Click the **Auto synchronize related series** menu option, or use shortcut K to change the current status. The highlighted icon  on the left side of the menu indicates, that default in **Link scrolled series** mode is changed to **Automatic**. The selection is saved in browser's local storage and **Automatic** Link scrolled series mode will be set when starting the viewer next time.

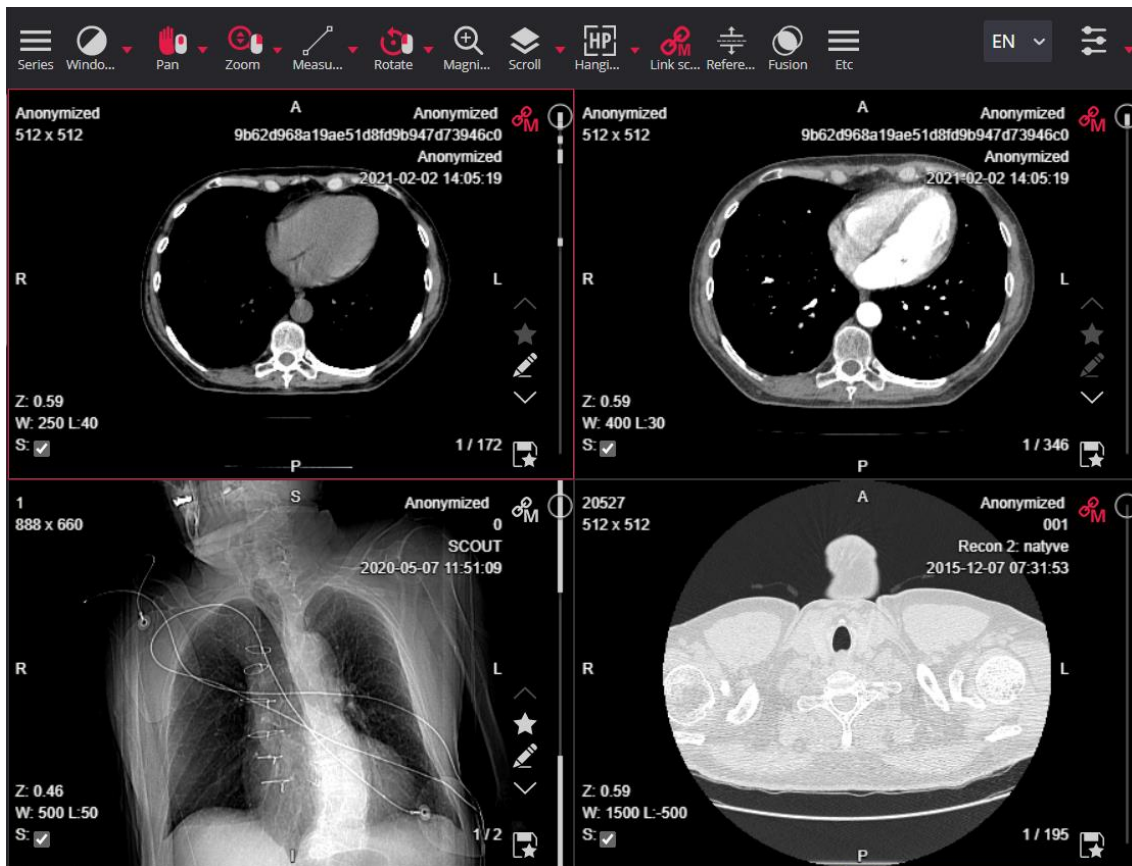

Figure 101. Manual link mode in Viewer with the disabled linked scrolling for one of the series

When automatic or manual link is enabled, and one or more viewports contains series with link button, you can do the following:

- Scroll the images of the linked series simultaneously:
 - In automatic mode, when scrolling images in the active series, the image in the linked series is selected according to the image position and slice thickness;
 - In manual mode, when scrolling images in the active series, the images in the linked series are scrolled one by one;
 - In distance mode, when scrolling images in the active series, the image in the linked series is selected according to the image position and distance from the reference image.
- Enable or disable the synchronous scrolling for a particular series by tapping the manual, automatic, or distance link button in the viewport. Highlighted icon indicates, that linking is enabled for the series.
- Open a new linked series in the viewer, if opening series meets the link criteria. The link button is displayed in the viewport, either with default value, or previous state, if the previous series was linked and the viewport already had link button displayed.

CAUTION! Note, that MedDream cannot guarantee that the manual series linking displays the images of the same patient and at the corresponding position.

NOTE! Link scrolling functionality works more efficiently when the series are preloaded.

Tools for measuring, and annotation saving

Measuring images



Measure button allows you to measure and analyze the images in number of ways. To pick the measure tool, use the **Measure** button drop-down menu:

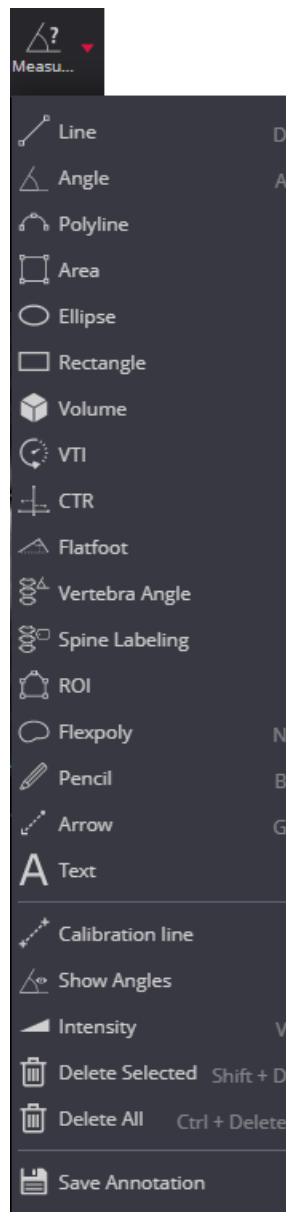

Figure 102. Measure button menu



NOTE! The tools in **Measure** button menu may vary depending on license type, active image type and system settings:

- **Measure** button is not displayed for structure reports (SR).
- ECG studies has different set of Measure tools (see [Presenter tool](#))



The presentation tool helps the user to temporarily mark an area of interest in a viewport to share knowledge with colleagues or students. The user can link one of the mouse buttons by selecting from three options:

Fading line,

Fading arrow,

Draw.

The first two certificates expire automatically after a set period of time. Selecting "Draw" keeps the highlight drawn by the user until the user selects "Clear All".



- Figure 293. Presenter tool
- The user can enable Laser pointer, which adds a dot to the cursor to help focus attention on the cursor position .
- The user can choose from 5 colours.

The colours that are selected from the menu are configured in the settings. It is also possible to change the fading time and the thickness of the line/arrow.



NOTE! Lines, arrows or curves drawn by the user are not redrawn when the layout is changed and remain on the screen where the user drew them.

- Special views).
- **TPA, Norberg Angle, VHS, Hip DI, and TTA** measuring is intended for veterinary usage. By default settings these tools are not shown in Measure menu for other than VET license types.
- **VTI** measuring is applicable and displayed only for US modality.

The top group of **Measure** menu contains the measuring tools. To use the measuring tool, assign mouse button to measure function: the mouse pictogram with assigned button is displayed . The system allows assigning the left, and the middle mouse button for measuring tool. The right mouse button may not be assigned for measuring tool. The highlighted tool pictogram indicates that tool is ready for measuring. You can change the active measuring tool by selecting the other tool in menu – the selected tool icon is displayed in Measure button:





 **NOTE!** You can use the tools, like zoom or pan, that are assigned to other mouse buttons, to adjust the image while performing the measurement.

 **NOTE!** The measuring tools is automatically deactivated after one measurement is finished: . To measure with the same tool several times, use the Pin measurement function.

The divider line in expandable **Measure** button menu separates the measuring tools from supporting functions. The detail measuring tools and supporting functions description is provided in following sub-sections.

 **WARNING!** MedDream cannot guarantee the accuracy of calibration data received from the modality. Note, that MedDream cannot guarantee that the manual calibration which is performed by users is done accurately.

 **WARNING!** The accuracy of the measurements is affected by the calibration status of the monitor. Monitor calibration ensures that tones that are lighter than black are displayed clearly separately from true black, and tones that are darker than white are clearly distinguished from true white. How to calibrate the monitors is described in the software installation instructions, which are provided separately in this user guide.

 **WARNING!** Note, that measuring functions in MedDream is approximate.

Line

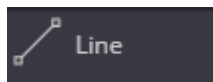

The **Line** tool helps to measure the distance between objects:

- select **Line** tool in **Measure** menu;
- place the mouse cursor on the starting point, click and release the selected mouse button;
- move the cursor to the end point, click the selected mouse button and release it;
- the distance will be displayed in yellow:



Figure 103. Distance measurement

Use „Alt“ key to draw vertical or horizontal lines. Hold the „Alt“ key pressed while drawing the line measurement. The system automatically aligns line horizontally or vertically, depending which direction is closer to current cursor position. Do not release the “Alt” key until line measurement is not finished.

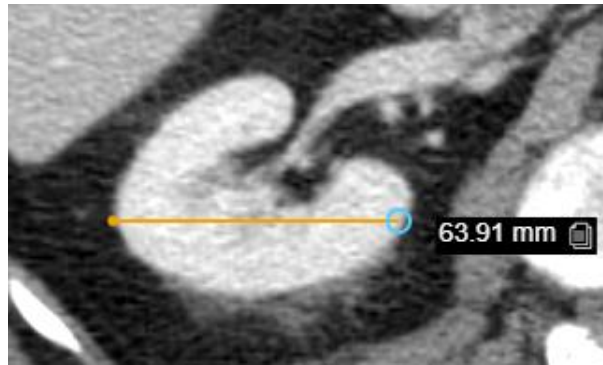
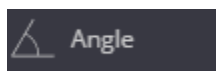

Figure 104. Horizontal line drawing, holding the "Alt" key pressed

Angle



Angle tool is used to measure the angle:

- select **Angle** tool in **Measure** menu;
- position the mouse pointer on the point from which you want to measure the angle, click and release the selected mouse button;
- move the pointer to the second point (the apex), click and release the selected mouse button again;
- move the pointer to the end point and click the selected mouse button again – the angle is displayed on the image:



Figure 105. Angle measurement

Cobb Angle

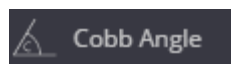

The **Cobb angle** button is used to measure angle between lines. To measure angle:

- select **Cobb angle** tool in **Measure** menu;
- click on image and draw two lines, parallel to the most tilted vertebrae,
- the system measures and displays:
 - the corner; the angle is measured at the point where two lines drawn by the user would intersect if they were extended as straight lines;
 - the distance between the midpoints of the lines drawn by the user;

- you can drag lines and line points, or the whole measurement object by dragging the white dotted line.

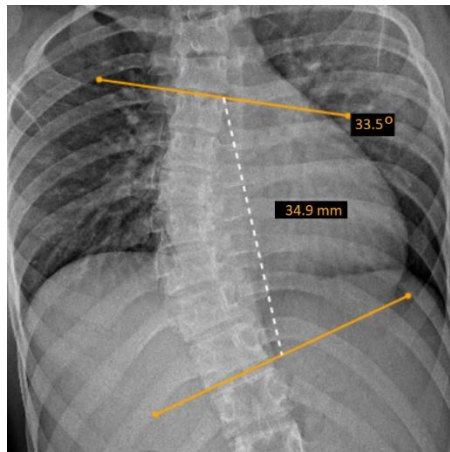
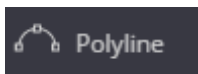

Figure 106. Cobb angle measurement

Polyline



The **Polyline** tool is used to measure the distance or perimeter of a region of interest:

- select **Polyline** tool in **Measure** menu;
- position the mouse pointer on the point from which you want to start measuring, click and release the selected mouse button;
- then move the cursor to the second, third, fourth, etc. points and each time click the selected mouse button once and release it;
- when the cursor is moved to the last point, double click the selected mouse button, and the total length of all the lines is displayed. If you place the last point on top of the first point, you will get the perimeter:

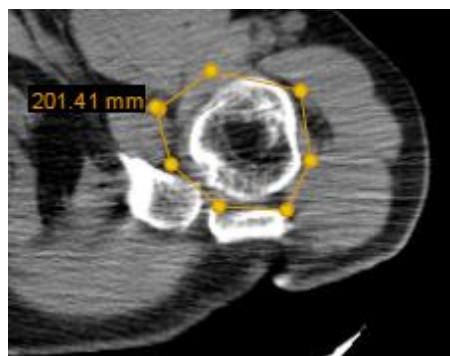

Figure 107. Perimeter measurement

Area



The **Area** tool is used to measure the area of a region of interest:

- select **Area** tool in **Measure** menu;
- mark points around the area of interest, as described in Polyline tool section;

- when you reach the last point, double click the selected mouse button twice - the area (in square millimeters) will be displayed:

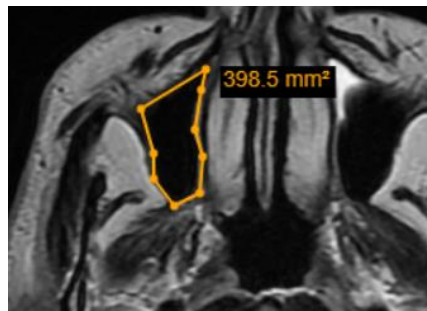
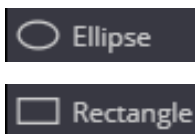

Figure 108. Area measurement

Ellipse and Rectangle



Ellipse and **Rectangle** is used to measure area in cm^2 units, length and width in cm units, minimum, maximum and medium brightness (marked *Mean*) in *HU* units and for the standard deviation (marked *SD*), which gives the variance of the random variables about the mean, in *HU* units:

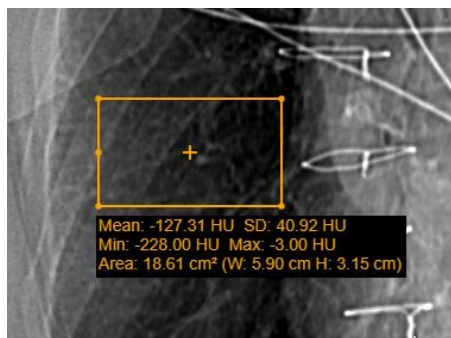
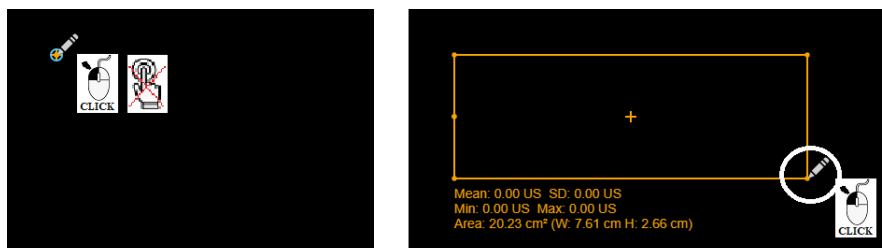

Figure 109. Rectangle measurement

To measure an area of interest using **Ellipse** or **Rectangle**, you can measure in two ways:

- press the left mouse button at the point that will be the starting point of the measurement, and immediately release the left mouse button; then move the mouse cursor to the opposite point of the **Ellipse** or **Rectangle** and click the left mouse button again to complete the measurement;



move the mouse, place the dot with "click" and release the left mouse button, move to the opposite corner of the rectangle, after reaching the right place, "click" the left mouse button again

Figure 110. The first way to measure Ellipse or Rectangle

- press the left mouse button on the point that will be the starting point of the measurement, and without releasing the left mouse button, drag the cursor to the opposite point of the **Ellipse** or **Rectangle**, then release the left mouse button, thus completing the measurement.

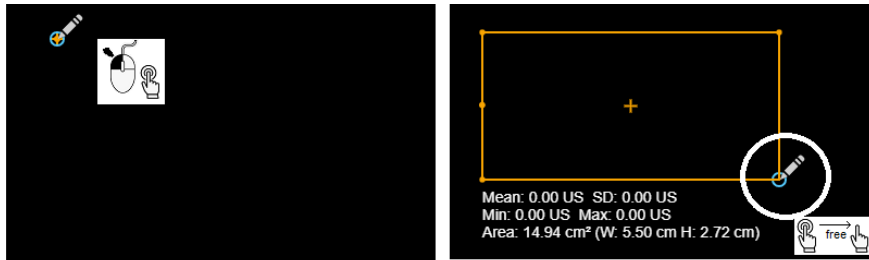

place a point, without releasing the left mouse button, move to the opposite corner of the rectangle, when you reach the right place, release the left mouse button

Figure 111. The second way to measure Ellipse or Rectangle

To mark the area of interest as **Circle** or **Square**, press the **ALT** key during the measurement. The system automatically:

- Ellipse** will be changed to **Circle** whose diameter is equal to the length of the shortest axis of the ellipse;
- Rectangle** will be changed to a **Square** whose sides are equal to the length of the shortest axis of the rectangle.

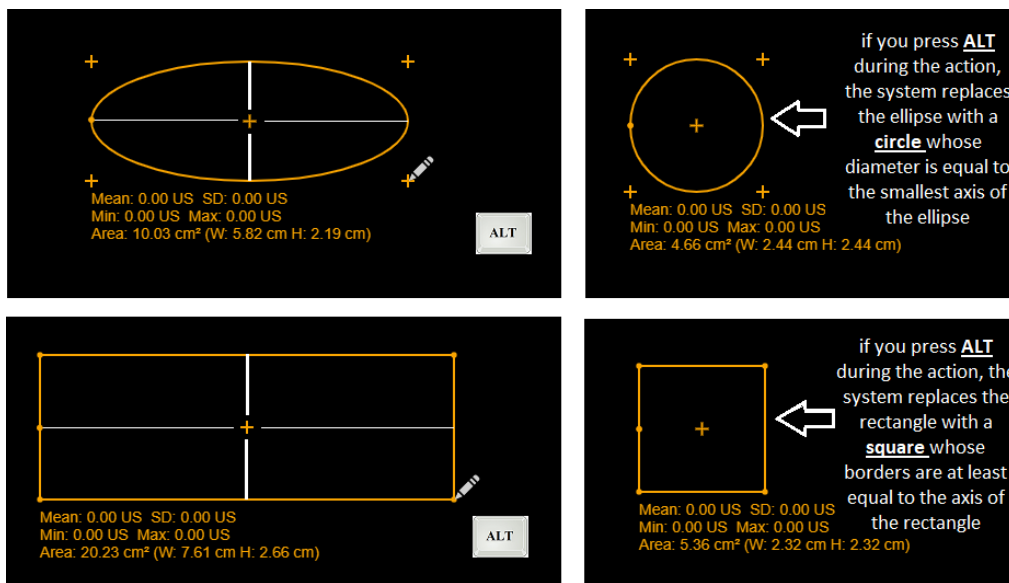

Figure 112. Replacing an ellipse with a circle. Replacing a rectangle with a square

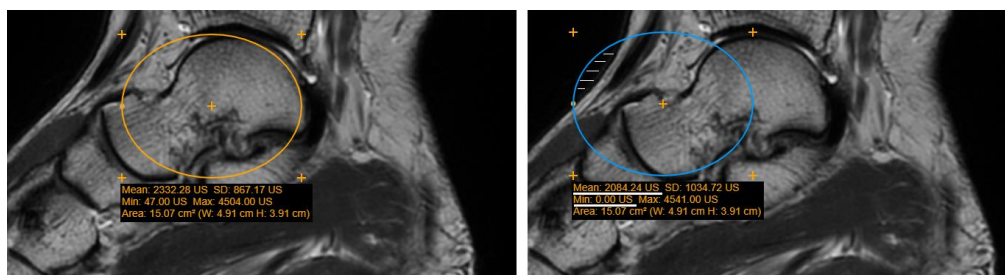



Figure 113. Ellipse measurement

NOTE! If the **Ellipse** or the **Rectangle** measurement range is defined beyond the body contour then the minimum brightness will be 0 and the average brightness may decrease significantly.

To resize **Ellipse**, mouse over any point outside the measurement that is marked with a plus **+**. The icon will change to a blue circle . Press the left mouse button and without releasing move the point in any direction, decreasing or increasing **Ellipse**.

If you press the **ALT** key during editing, the system will change **Ellipse** to **Circle** with a diameter at least equal to the axis of the ellipse.

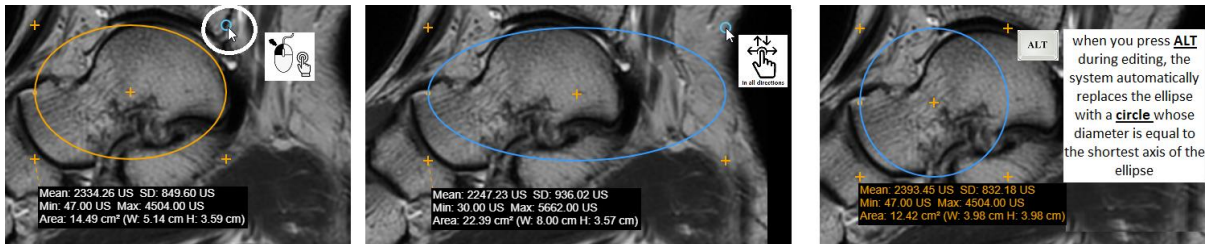



Figure 114. Ellipse editing

To change **Rectangle**, mouse over any corner point, the icon will change to a blue circle . Press the left mouse button and without releasing the point move the point in any direction, decreasing or increasing **Rectangle**.

If you press the **ALT** key during editing, the system will change **Rectangle** to **Square** with sides equal to the shortest axis of the rectangle.

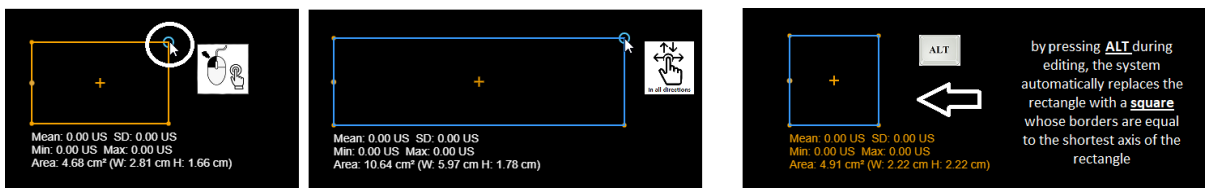





Figure 115. Rectangle editing

To change the position of the **Ellipse** or **Rectangle**, move the mouse cursor to the center point, which is marked with a plus **+**. The center icon will change to a blue circle . Press the left mouse button and without releasing move the **Ellipse** or **Rectangle** to another place in the image.

To rotate **Ellipse** or **Rectangle**, move the mouse cursor to the point , which is placed on the line , and when the point changes to blue circle, press the left mouse button and without releasing move the point.

Volume



The **Volume** button is used to measure the volume of the object.

The volume is calculated from a three-dimensional shape, which is obtained by rotating the left and right plane shapes around the axis of rotation by 180 degrees.

! **NOTE!** The user must predict the axis of rotation, the upper and lower points of the axis of rotation. The easiest way is to use other tools to draw perpendicular axes through the center of the area. The start and end points of one of the axes would be the upper and lower points of the axis of rotation.

With skill, it is possible not to use additional tools and the center and to predict the start and end points by eye.

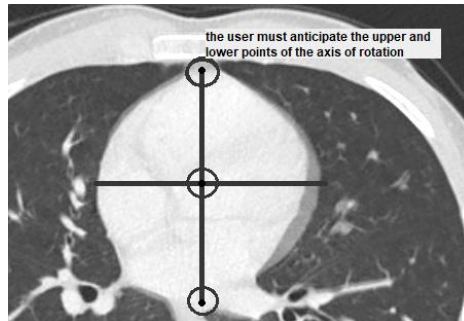

Figure 116. Volume measurement

In the **Measure** menu, select the **Volume** tool:

- place the mouse cursor on the upper point of the axis of rotation, click once and release the selected mouse button;
- then move the cursor to the second, third, fourth, etc. points by clicking and releasing the selected mouse button once on each of them;

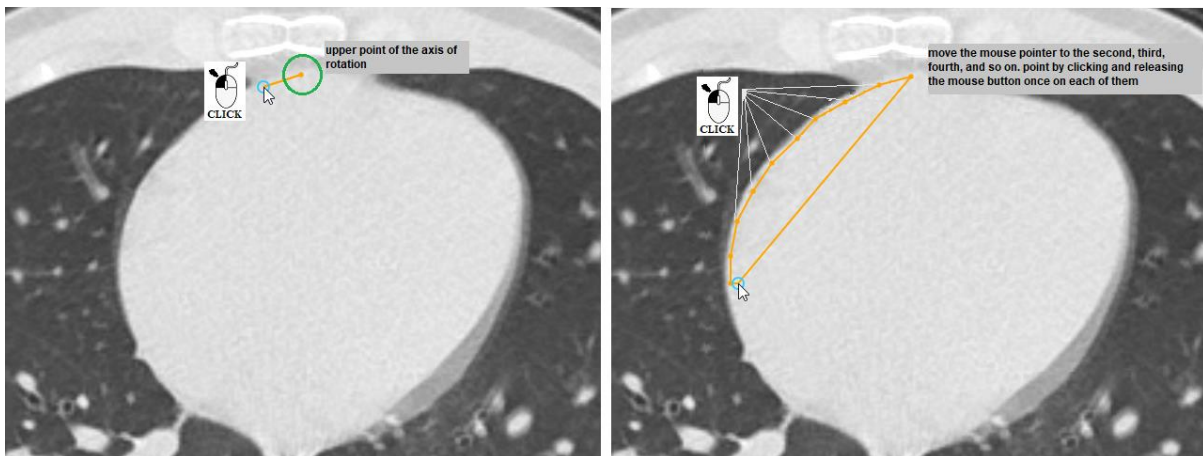

Figure 117. Start of marking the contour of the measuring area

- when you reach the bottom point of the axis of rotation, press the selected mouse button twice - the program marks the axis of rotation;

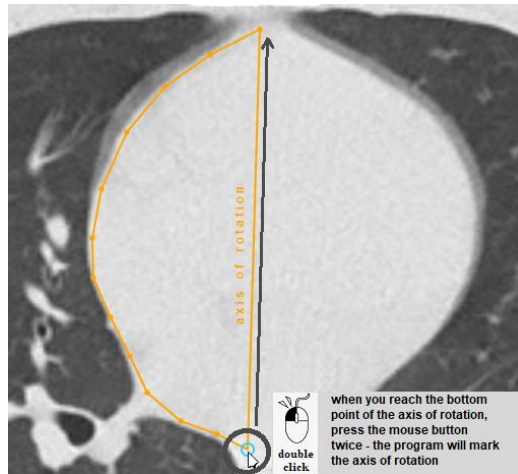

Figure 118. The axis of rotation

- continue marking points on the other side of the axis of rotation by clicking and releasing the selected mouse button once on each of the points;
- when you reach the last point, press the selected mouse button twice;

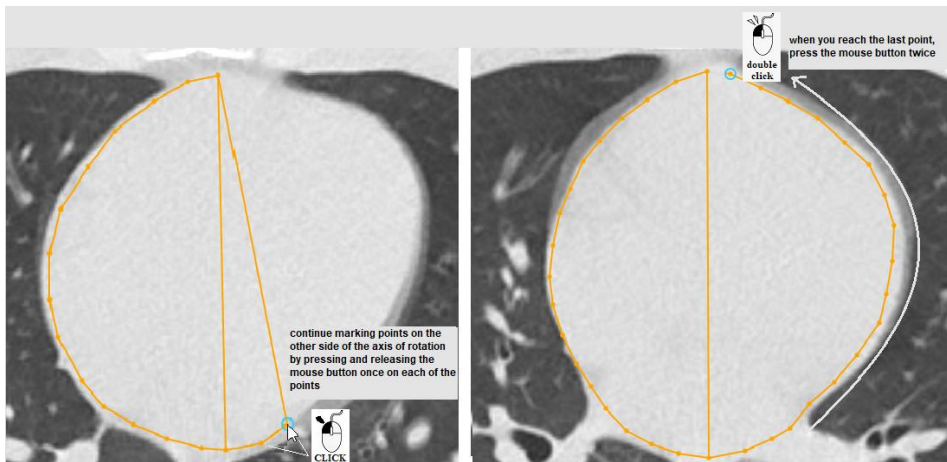

Figure 119. End of contour marking of the measuring area

- the last point is connected to the starting point of the axis of rotation; the left and right sides of the figure are rotated 180 degrees in space around the axis of rotation, at + 90° and -90°; the resulting three-dimensional figure;

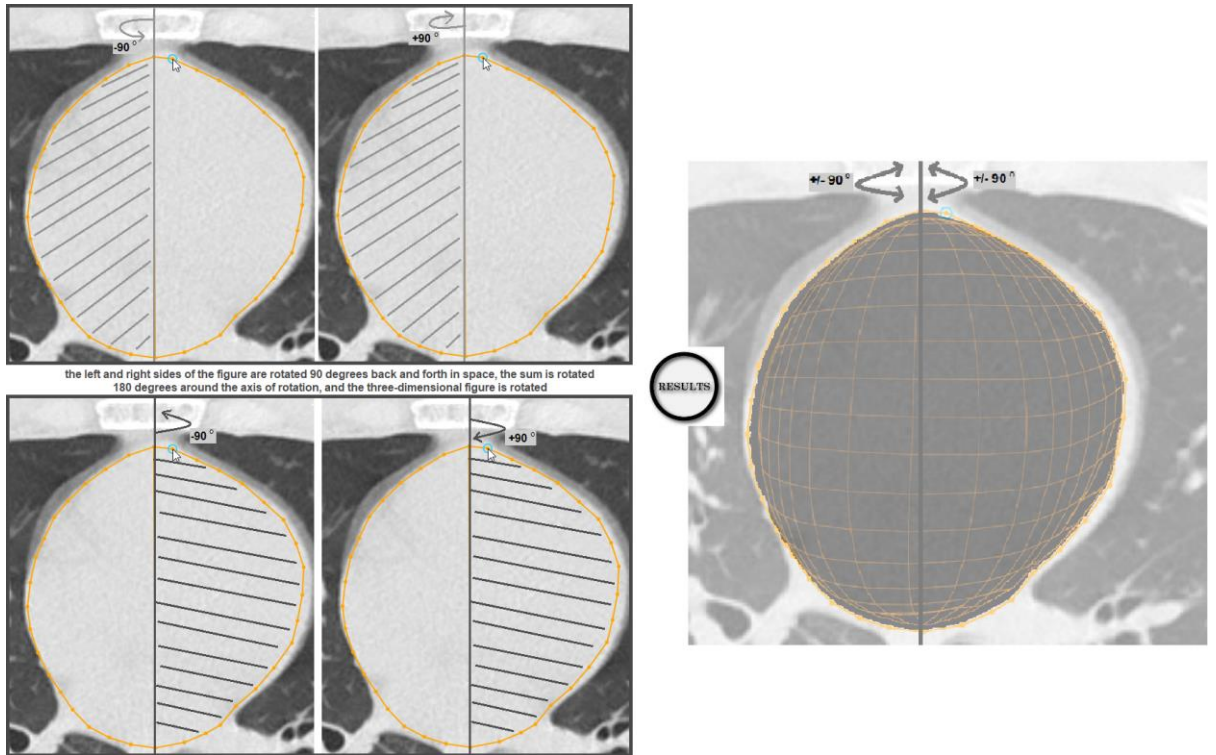

Figure 120. The three-dimensional shape formation

- when calculating the volume, the three-dimensional figure is divided into 20 equally spaced cross-sections; the result is a vertical section showing the transverse lines of the section;

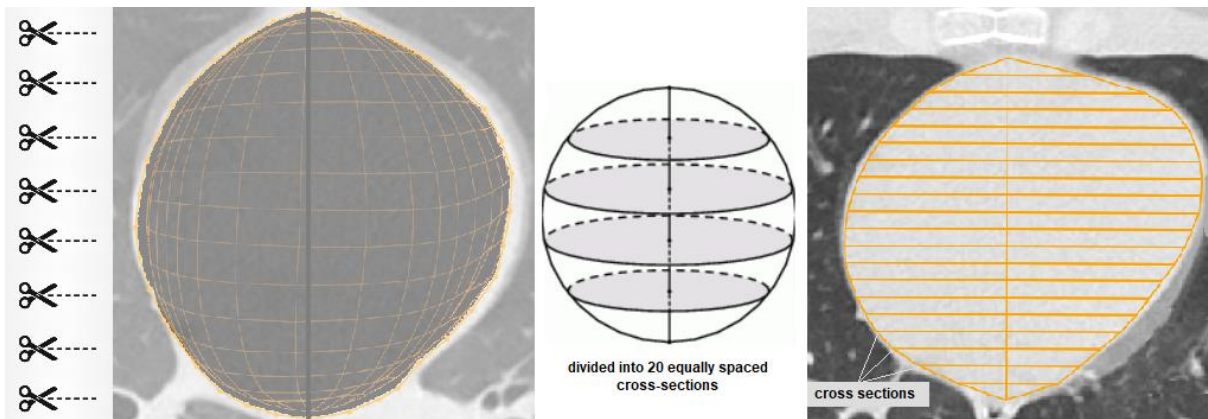

Figure 121. The Area calculation

- The result shows the perimeter (mm), area (mm²), and volume (mm³) of the resulting 3D three-dimensional shape.

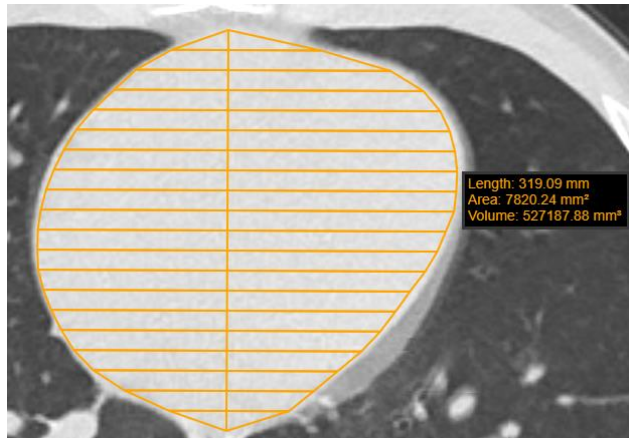

Figure 122. The result of volume calculation

The user can mark the area to be measured with different shapes, as needed, from which different three-dimensional shapes will be obtained.

For example, if the user defines two triangles, the result will be a cone:

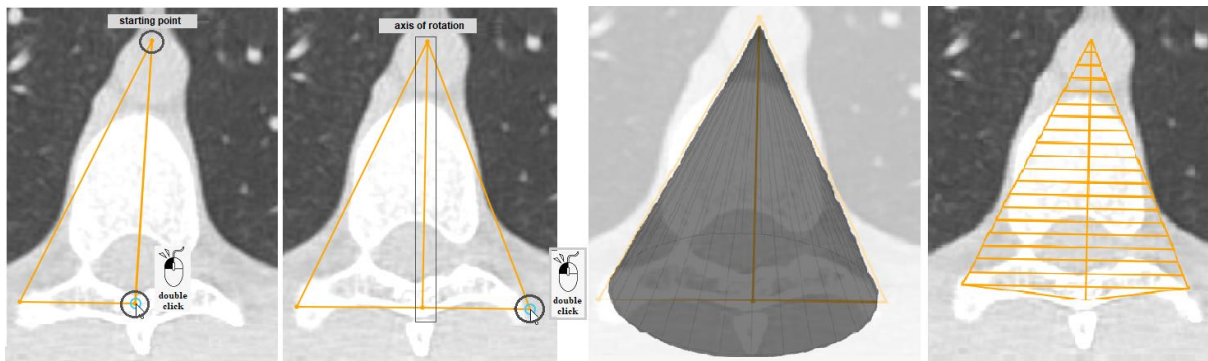

Figure 123. The cone volume

For example, if the user defines two rectangles, the result will be a cylinder.

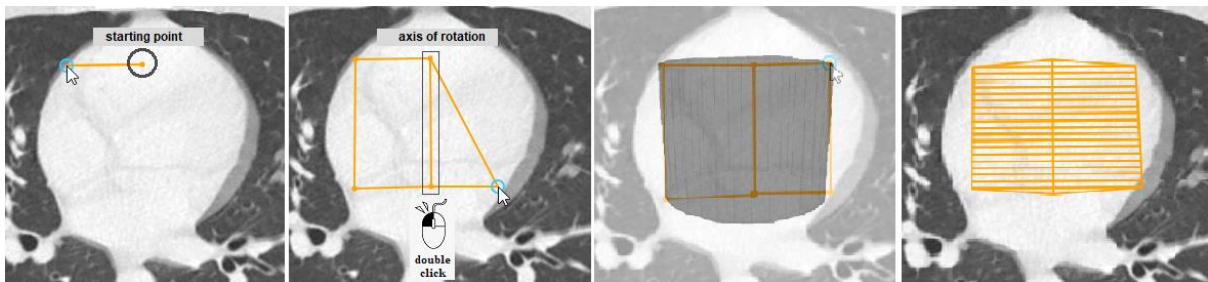

Figure 124. The volume of a cylinder

As the user draws more complex, irregular shapes, the three-dimensional shape becomes correspondingly more complex.

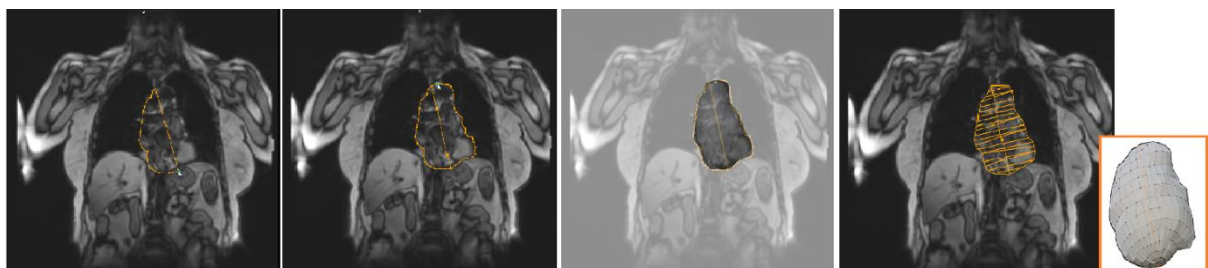

Figure 125. The volume of an irregular figure

NOTE! When calculating volume for three-dimensional shape, the system transforms the spatial shape by discarding the area behind the perpendicular lines drawn through the start and end points.

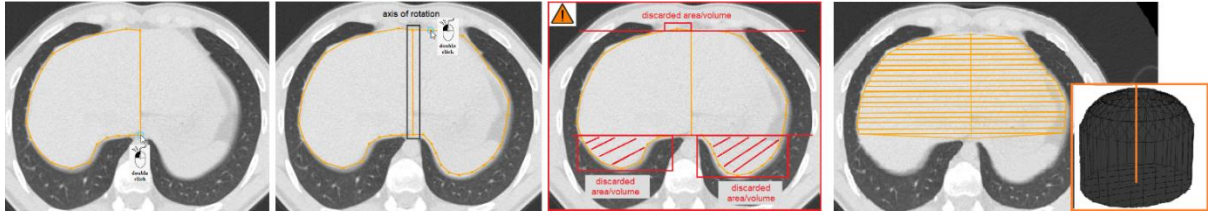

Figure 126. The area / volume outside the axis of rotation is rejected

NOTE! If, when the lower point of the axis of rotation is reached, the following points are marked on the same side of the axis of rotation, a hollow rotation is obtained.

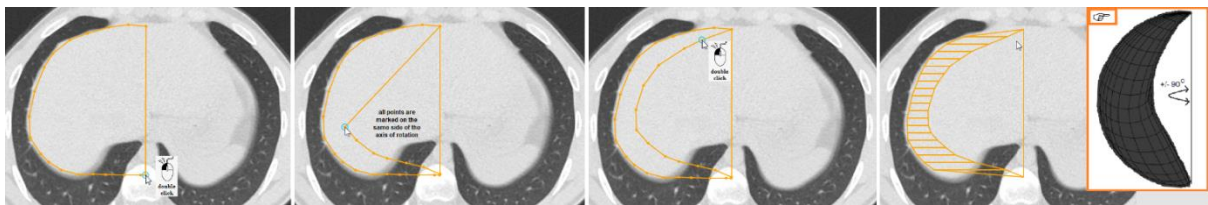
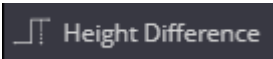

Figure 127. The hollow three-dimensional shape

Height Difference



The **Height Difference** measures the vertical distance between two points and the angle between the horizontal line and the line connecting the points, and may be used for measuring the shoulder balance, for example. To perform a height difference measurement:

- open the radiograph image,
- select Height Difference tool in Measure menu,
- place the mouse cursor on the first point, for example at the highest point of the right clavicle, and click the selected mouse button,
- move the cursor to the highest point of the left clavicle and click the selected mouse button again,
- the system draws the connected horizontal lines, and measures the vertical distance and angle between the horizontal line and the line connecting the points.

NOTE! The height difference measurement is performed in image coordinate system. Vertical distance is measured in absolute value. Angle is measured in range from -90 degrees to +90 degrees.

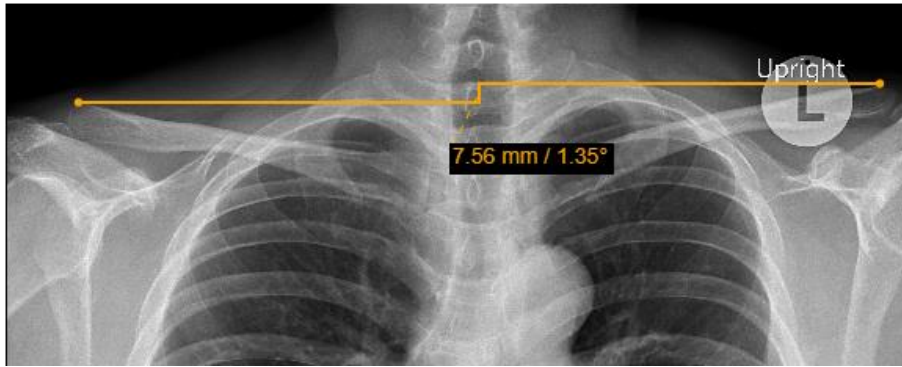

Figure 128. Height difference measurement

You can adjust the measurement according to your needs by dragging the points or the whole measurement.

Velocity Time Integral (VTI)



The **VTI** (*Velocity Time Integral*) button is used to measure the distance over which the blood was ejected per interval of time:

- select **VTI** tool in **Measure** menu;
- place the mouse cursor on the point from which you want to measure the velocity time integral, click and release the selected mouse button;
- then move the cursor to the second, third, fourth, etc. points of measured blood velocity profile and each time click the selected mouse button once and release it;
- when you reach the last point, double click the selected mouse button, and measurements of marked velocity profile are displayed:

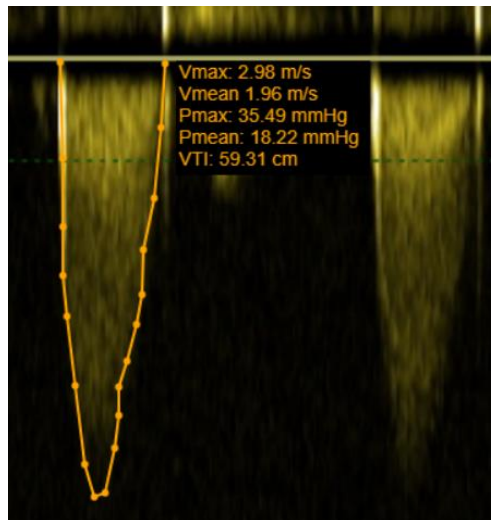

Figure 129. VTI measurement



NOTE! VTI measuring tool is applicable only for the images of "US" modality with visible blood velocity profile.

Tibial Plateau Angle



The **TPA** button is used to measure angle between two lines: the tibial plateau slope line and the line that is perpendicular to tibia axis line.

To measure angle:

- select **TPA** tool in **Measure** menu;
- draw the tibia axis line (A):
 - start from the ankle. Point the mouse cursor on the edge of the talus, click the selected mouse button, move the mouse to the center of talus, and click the mouse button - the system automatically draws the circle for better location of the talus center when moving the mouse;
 - then move the mouse to the other side of the tibia and click the mouse button – the system automatically draws the line while moving the mouse;
- draw the tibial plateau slope line (B) by clicking mouse button on one and the other end of the line;
- through lines intersection point the program draws the line (dashed line C), that is perpendicular to the tibia axis line A, and displays the angle between the line C and tibial plateau slope line B:



Figure 130. Tibial Plateau Angle (TPA) measurement

- you can adjust the circle size by dragging the dot on the circle, drag the line points, or the whole measurement object simultaneously.



NOTE! TPA, Norberg Angle, VHS, Hip DI, and TTA measuring is intended for veterinary usage. By default settings these tools are not shown in Measure menu for other than VET license types.

Norberg Angle

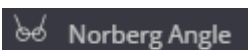

The **Norberg Angle** button is used to evaluate canine hips. To measure the angle:

- zoom in the selected image and select **Norberg Angle** tool in **Measure** menu;

- point the mouse cursor on the surface of femoral head, click the selected mouse button, and draw the circle, fitting the femoral head - the first circle of the Norberg angle:

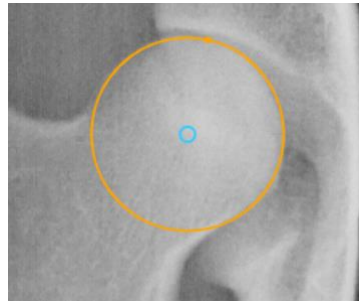

Figure 131. Norberg angle circle with the center in femoral head

- repeat the same process on other femoral head – draw the second circle of the Norberg angle;
- the program joins the circle centers with a line and draws a line from each center at 105.0 degrees - the Norberg angle for good hip:



Figure 132. Norberg angle measurement

- drag the upper points of lines to fit the cranial acetabular rim for measuring the actual Norberg angle:



Figure 133. Adjusted Norberg angle measurement

- you can adjust the circle size by dragging the dot on the circle, or adjust circle position by dragging the circle center, or the whole measurement object by dragging the center line.



NOTE! TPA, Norberg Angle, VHS, Hip DI, and TTA measuring is intended for veterinary usage. By default settings these tools are not shown in Measure menu for other than VET license types.

Verbal Heart Scale



The **VHS** (Vertebral Heart Scale) button is used to measure heart size and provide an accurate assessment of true cardiac enlargement. To perform a VHS measurement:

- select **VHS** tool in **Measure** menu;
- place the mouse cursor and click the selected mouse button on the point from which you want to start measuring Long Axis (L),
- move the cursor to the end point of long axis and click the selected mouse button again - the Long Axis line will appear:

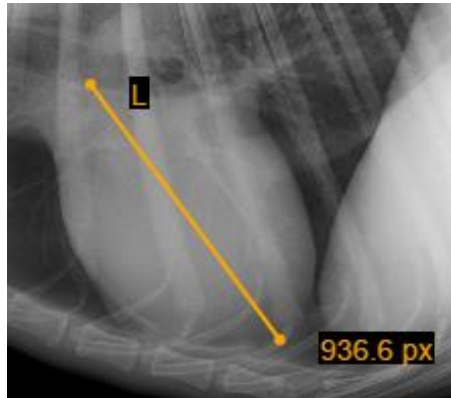

Figure 134. Long axis of VHS measurement

- place the mouse cursor and click the selected mouse button on the point from which you want to start measuring Short Axis (S);
- move the cursor to the end point of short axis and click the selected mouse button again – the Short Axis line will appear:

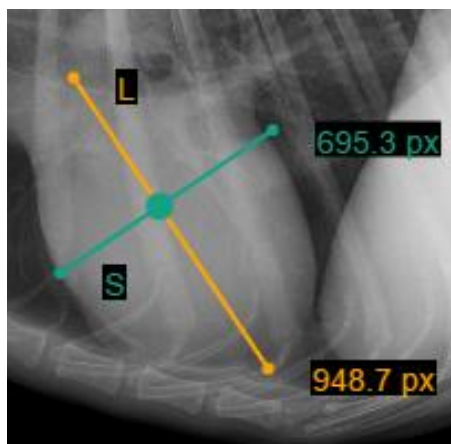

Figure 135. Short Axis of VHS measurement

- In order to define SL point, place your mouse cursor and click the left mouse button on the point from which you want to measure S and L lines - S and L lines will appear:

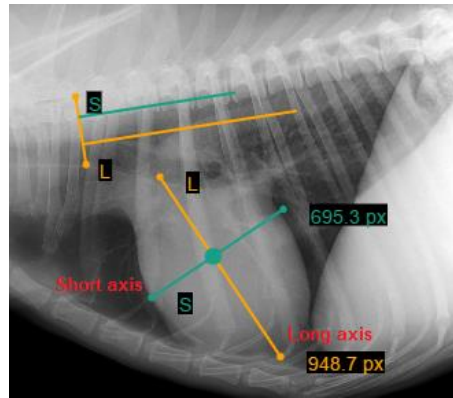

Figure 136. VHS measurement

You can rotate lines by dragging the ends of the line (dots) according to your needs. Click the left mouse button on the yellow dot (highlighted in red) and drag the line into a position where you want it to be. Middle vertical line (S and L line intersection point) allows to move S and L lines at the same time:

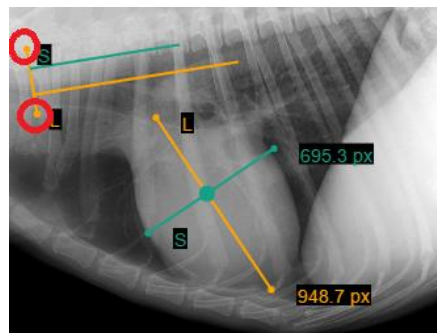

Figure 137. S and L lines rotation



NOTE! TPA, Norberg Angle, VHS, Hip DI, and TTA measuring is intended for veterinary usage. By default settings these tools are not shown in Measure menu for other than VET license types.

Hip distraction index



The **Hip distraction index (DI)** measurement allows evaluating the laxity of hip joint. The DI is calculated as ratio of distance between centers of acetabulum and femoral head, and radius of femoral head. To measure the hip distraction index:

- zoom in the selected image and select **Hip DI** tool in **Measure** menu;
- point the mouse cursor on the surface of acetabulum socket, click the selected mouse button, and draw the circle, fitting the acetabulum socket;
- point the mouse cursor on the surface of femoral head, click the selected mouse button, and draw the next circle, fitting the femoral head;
- the program draws and measures the distance between centers of circles, the radius of the second circle (femoral head), and calculates the distraction index from the measured values:

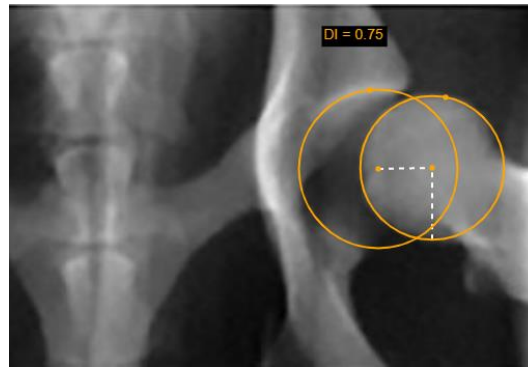

Figure 138. Hip distraction index measurement

- you can adjust the circle size by dragging the dot on the circle, or position of individual circle by dragging the circle center, or move the whole measurement object by dragging the distance or radius lines.



NOTE! TPA, Norberg Angle, VHS, Hip DI, and TTA measuring is intended for veterinary usage. By default settings these tools are not shown in Measure menu for other than VET license types.

Tibial tuberosity advancement



The **TTA** measurement allows estimating the cage width of tibial tuberosity advancement (TTA) in the surgical stabilization of the dog's knee joint. Common tangent parallel lines method is applied for measuring. To measure the cage width:

- zoom in the selected image and select **TTA** tool in **Measure** menu;
- point the mouse cursor on the surface of tibial plateau, click the selected mouse button, and draw the circle, fitting the area of contact of the tibial plateau;
- point the mouse cursor on the surface of femoral condyle, click the selected mouse button, and draw the next circle, fitting the joint surface of the femoral condyle;
- point the mouse cursor on the most proximal point of the tibial crest and click the selected mouse button;
- the program joins the circle centers with a line, draws two parallel ruler lines with measured distance between them, and the guideline, perpendicular to all the three lines:



Figure 139. TTA ruler lines displayed by the program

- drag the outer ruler line to touch the distal patellar pole at the origin of the patellar ligament - the system measures the distance between ruler lines, that corresponds to the TTA cage width:



Figure 140. Adjusted TTA cage width measurement

- you can adjust the position of ruler lines by dragging the lines, or circle size by dragging the dot on the circle, position of individual circle by dragging the circle center, or the whole measurement object by dragging the perpendicular guideline.

⚠ NOTE! TPA, Norberg Angle, VHS, Hip DI, and TTA measuring is intended for veterinary usage. By default settings these tools are not shown in Measure menu for other than VET license types.

Cardiothoracic ratio



The **CTR** (Cardiothoracic ratio) button is used to measure the ratio of maximal horizontal cardiac diameter to maximal horizontal thoracic diameter and aids in the detection of enlargement of the cardiac silhouette. To perform a CTR measurement:

- select **CTR** tool in **Measure** menu,
- place the mouse cursor and click the selected mouse button on the point at the inner border of rib in the widest place of thoracic cavity to start measuring thoracic diameter,
- move the cursor to the inner border of the same rib on the other side of thoracic cavity and click the selected mouse button again - the thoracic diameter line and measurement description with length of the line will appear while drawing:



Figure 141. Drawing the maximal inner thoracic diameter line of CTR measurement

- place the mouse cursor and click the selected mouse button at the most left point of the cardiac shadow,
- move the cursor towards the right edge of the cardiac shadow - the cardiac shadow transverse line and processing note in measurement description will appear while drawing:

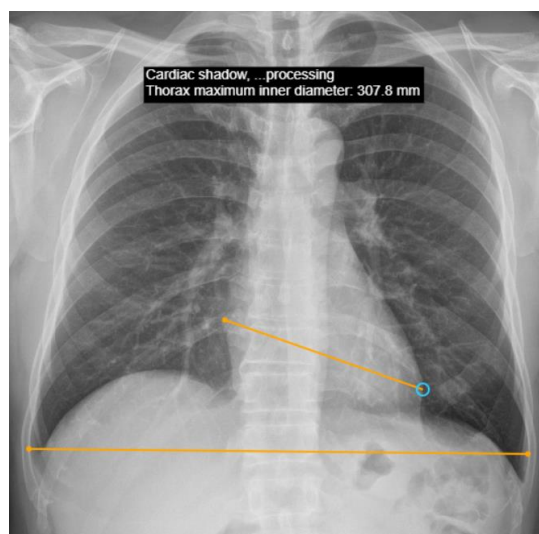

Figure 142. Drawing cardiac shadow transverse line of CTR measurement

- click the selected mouse button at the most right point of the cardiac shadow to finish the cardiac shadow transverse line to finish the CTR measurement,
- the system draws the midline of the thorax, and cardiac shadow diameter as two perpendiculars from the ends of the cardiac shadow transverse line to the midline. The cardiothoracic ratio is calculated as the percentage ratio of cardiac shadow diameter to maximal inner thoracic diameter, and displayed in the measurement description:

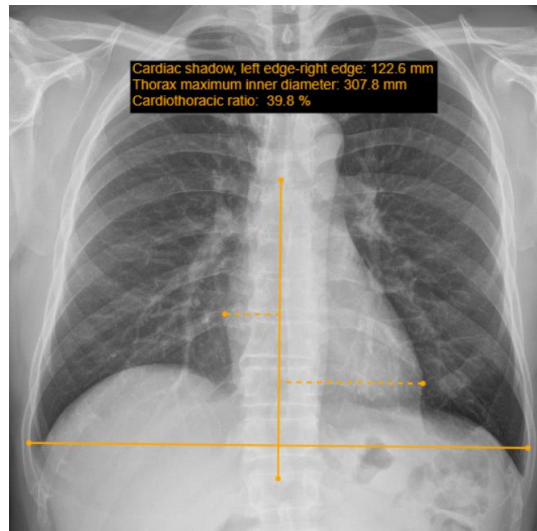
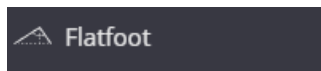

Figure 143. CTR measurement

You can adjust the measurement according to your needs by dragging the ends of the lines, or the whole thoracic diameter line, or the midline.

Flatfoot



The **Flatfoot** button is used to measure the angle and height of the foot medial longitudinal arch and aids in the detection of the longitudinal flatfoot. To perform a foot medial longitudinal arch measurement:

- open the foot radiograph image,
- select Flatfoot tool in Measure menu,
- place the mouse cursor on the point at the lower margin of calcaneus and click the selected mouse button,
- move the cursor to the lowest margin of cuneonavicular joint and click the selected mouse button again – the line connecting the point and cursor will appear while moving the cursor,
- move the cursor to the lowest margin of the first metatarsal and click the selected mouse button to finish the foot medial longitudinal arch measurement - the line connecting the second and third points will appear,
- the system measures and displays arch angle on the image,
- the system draws the line through the angle's end points and measures the distance from the angle vertex to this line.



Figure 144. Flatfoot measurement

You can adjust the measurement according to your needs by dragging the vertices of the angle.

Goniometry

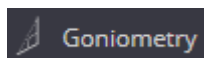

The **Goniometry** button is used to measure the lengths of femur and tibia, and the femoral-tibial angular deformities (genu varum and genu valgum). To perform a goniometry measurement:

- open the lower limb radiograph image;
- select Goniometry tool in Measure menu;
- draw the circle around femoral head to define the center of the femoral head:
 - point the mouse cursor on the edge of femoral head, and click the selected mouse button to start drawing,
 - move the cursor towards the center of the femoral head to draw the circle around the femoral head, and click the selected mouse button when done;



Figure 145. Drawing the femoral head circle of Goniometry measurement

- draw the knee transverse line to define the center of knee:
 - point the mouse on the most lateral point of the knee joint, and click the selected mouse button to start drawing,
 - move the cursor towards the most medial point of the knee joint to draw the knee transverse line, and click the selected mouse button when done;

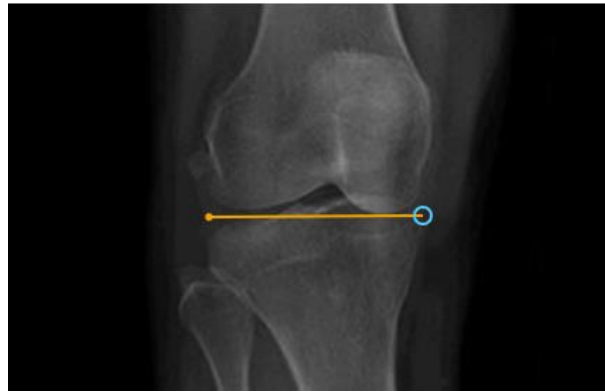

Figure 146. Drawing the knee transverse line of Goniometry measurement

- draw the talus and ankle contact line to define ankle center:
 - point the mouse on the most lateral point of the talus and ankle line, and click the selected mouse button to start drawing,
 - move the cursor towards the most medial point of the talus and ankle line, and click the selected mouse button when done;

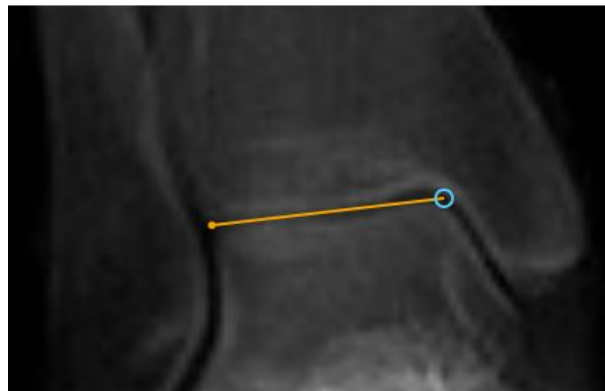

Figure 147. Drawing the talus and ankle contact line of Goniometry measurement

- the system draws the femur axis from the center of the femoral head to the center of the knee transverse line, and measures its length;
- the system draws the tibia axis from the center of the knee transverse line to the center of tibia and ankle line, and measures its length;
- the system shows the sum of measured leg segments (femur and tibia) length;
- the system measures and shows angle between femur axis and tibia axis.



Figure 148. Goniometry measurement

You can adjust the measurement by dragging the end points of the knee or ankle lines, or the whole lines. The center of the femoral head may be adjusted by dragging the dot on the circle, or dragging the circle center.

TT-TG Distance

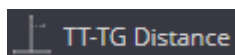

The **TT-TG Distance** button is used to measure the tibial tuberosity to trochlear groove distance for quantifying of the knee patellar instability. To perform a TT-TG distance measurement, the series should have the axial images of the femoral condyles, and the tibial tuberosity:

- open the image with the clearly visible femoral condyles and trochlear groove;
- select **TT-TG Distance** tool in Measure menu;
- draw the line along the posterior femoral condyles:

- point the mouse cursor on the edge of one femoral condyle, and click the selected mouse button to start drawing,
- move the cursor towards the edge of other femoral condyle to draw the line along the femoral condyles, and click the selected mouse button when done:

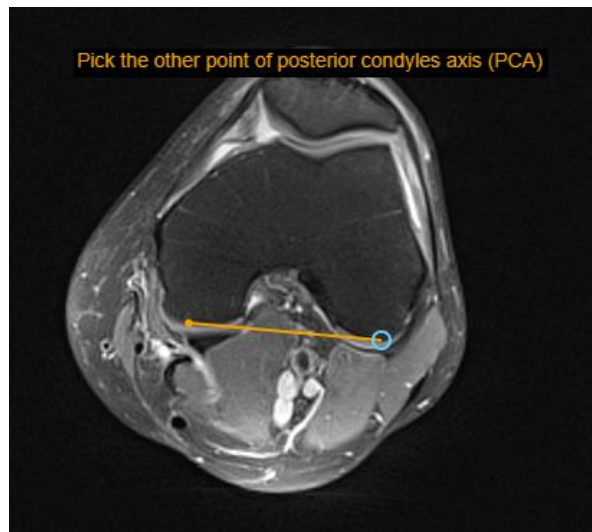

Figure 149. Drawing the line along the posterior femoral condyles of TT-TG Distance measurement

- the system finishes the femoral condyles line and displays the guidance for the next step;
- move the mouse to the deepest point of the trochlear groove, and click the selected mouse button to finish the TG line:

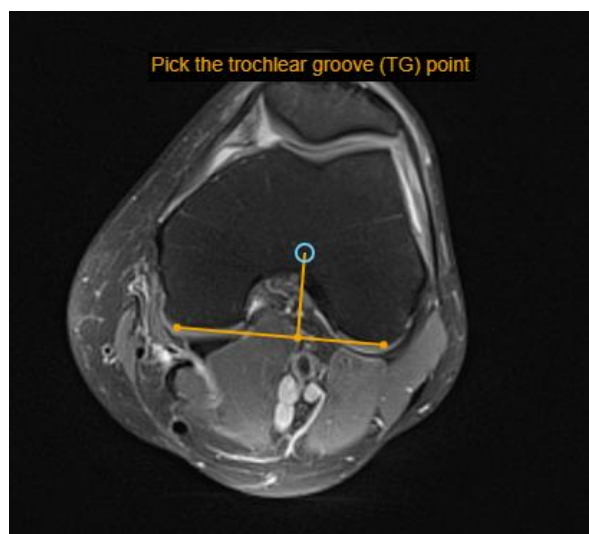

Figure 150. Drawing the TG line of TT-TG Distance measurement

- the system finishes the TG line, that is perpendicular to femoral condyles line, and displays the guidance for the next step;
- scroll the series to find the image with the clearly visible tibial tuberosity, and the system displays the already performed drawings and guidance while scrolling;

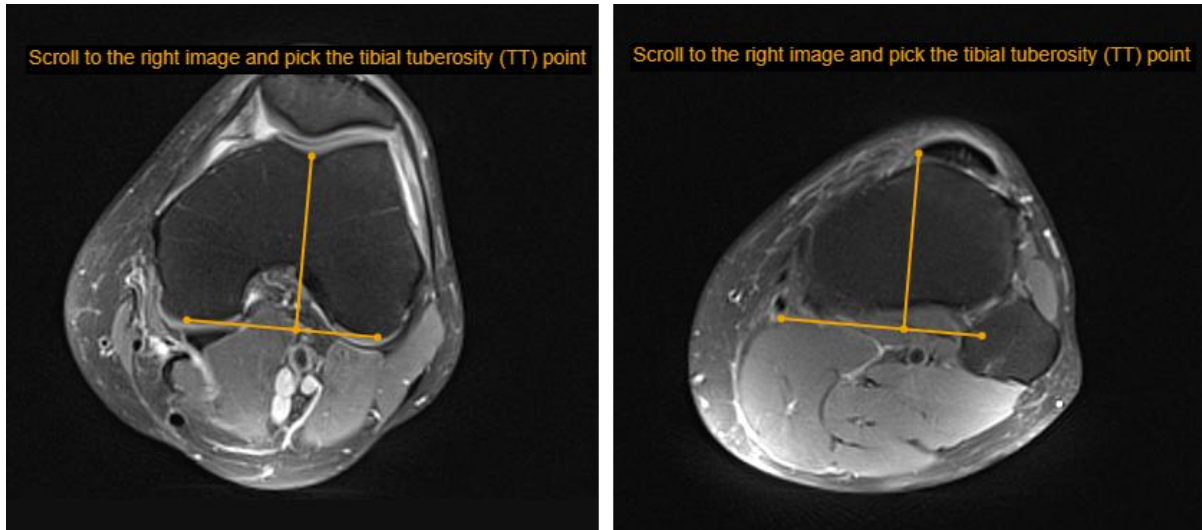

Figure 151. Finding the tibial tuberosity image in TT-TG Distance measurement

- when the right image is found, point the mouse on the most anterior point of the tibial tuberosity, and click the selected mouse button to draw the TT line;
- the system finishes TT-TG distance measurement:
 - the system finishes the TT line, that is perpendicular to femoral condyles line,
 - the system measures and shows the distance between parallel TT and TG lines,
 - the system fuses the femoral condyles and the tibial tuberosity images, on which the drawings were performed, and displays the opacity slider in the viewport:

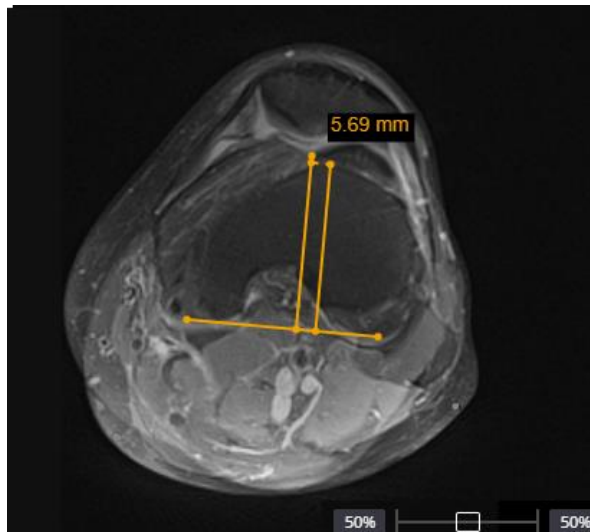
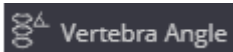

Figure 152. TT-TG Distance measurement

You can adjust the measurement by dragging the end points of the lines, or the whole measurement. By default, the 50% to 50% image fusion ration is applied. You can change the ratio with opacity slider, if better viewing of the one or the other image is needed for measurement adjustment.

! **NOTE!** If saved as presentations state, the TT-TG distance measurement is related only to the one image, for which the saving is performed. The editing and image fusion options are not available for saved presentation state.

Vertebra angle



The **Vertebra Angle** tool measures the angle between user drawn vertebra axis and horizontal axis of the image:

- Select the **Vertebra Angle** tool in **Measure** menu;
- place the mouse cursor on the starting point, click and release the selected mouse button;
- move the cursor to the end point, click the selected mouse button and release it;
- the angle between the line and the horizontal axis of the image will be displayed:

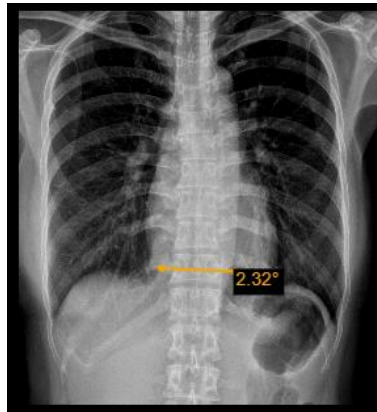
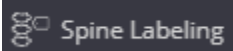

Figure 153. Vertebra angle measurement

Spine Labeling



The **Spinal Labeling** measurement is used to annotate the vertebrae of the spine. To perform the **Spine Labeling** measurement:

- open the image that shows the vertebrae of the spine;
- select the **Spine Labeling** tool in Measure menu;
- place the mouse cursor on the middle of the selected first vertebra and press the left mouse button;



Figure 154. The first vertebrae labeling

- in the action definition window, select the vertebrae that you clicked in the previous step, from which you want to start marking;

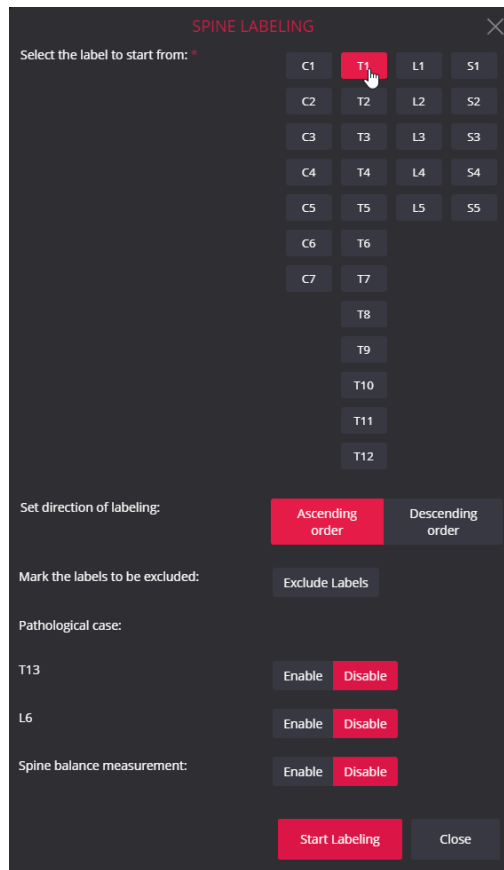

Figure 155. Spine Labeling Action Definition Window

- if the marking intended to perform from the last vertebra, on the image must be marked the relevant vertebral and changed the direction of labeling from the default “Ascending order” to “Descending order”;

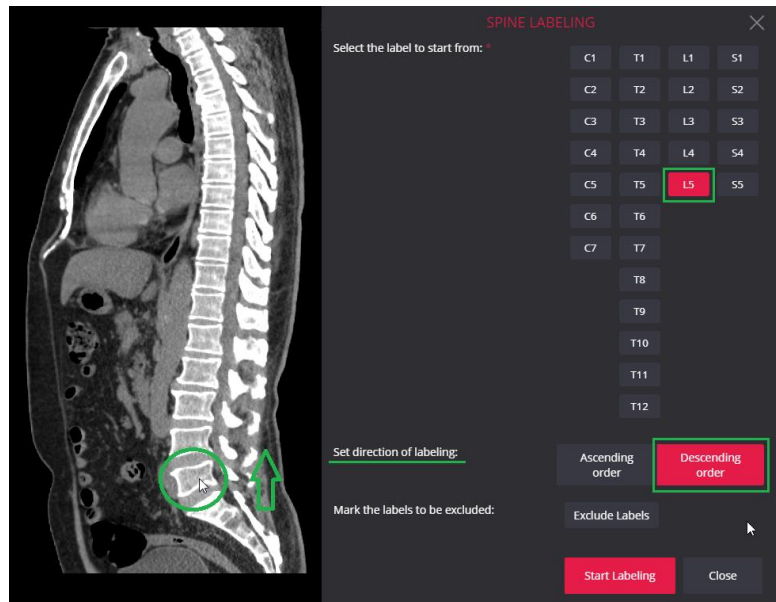

Figure 156. Spine Labeling action in descending order

- if some vertebrae do not need to be marked, select "Mark the labels to be excluded" → "Exclude labels" (1) in the action definition window, then in the list of labels use the mouse to highlight each unnecessary label (2) and confirm "Save labels" (3), the result - the marked labels will be skipped;

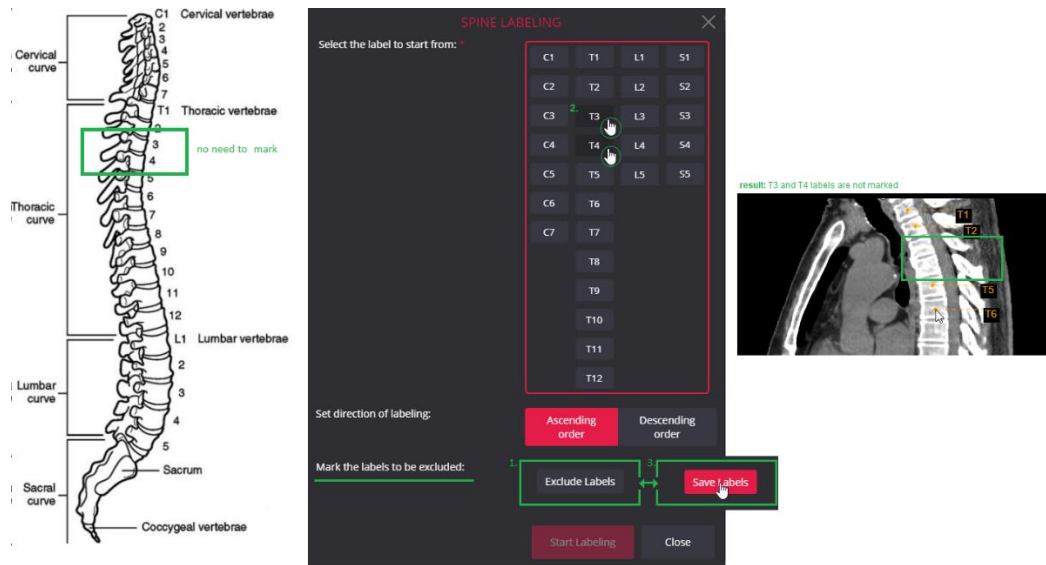

Figure 157. Definition of labels to be included in the Spinal Labeling action

- if the patient needs to mark pathological T13 and/or L6 vertebrae, activate the vertebrae in the lower part of the action window by selecting **Enable**, T13 and/or L6 vertebrae become visible in the list of vertebrae;

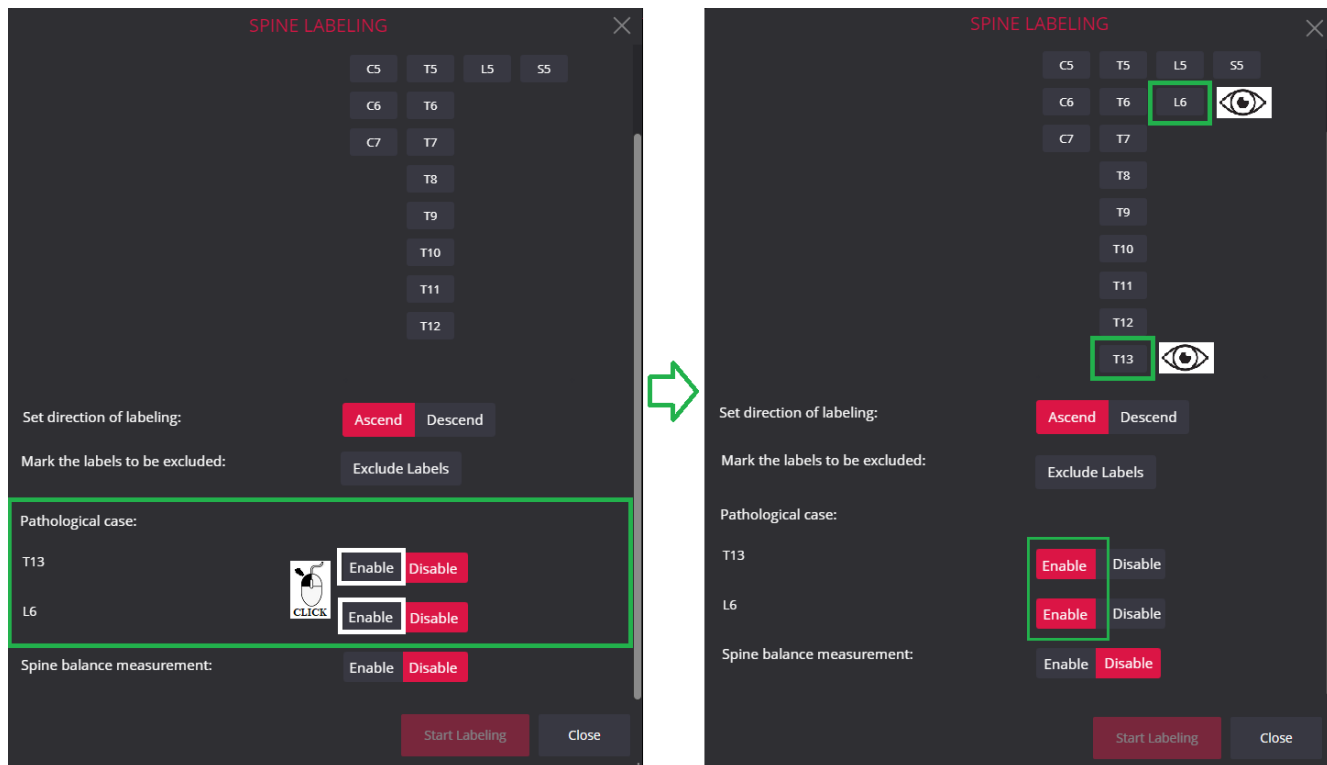

Figure 158. Spinal labeling pathological vertebrae T13 and L6

- to see the estimated spine balance between the C7 and S1 vertebrae at the end of the measurement, activate the measurement in the lower part of the action window by selecting **Enable**;

NOTE! Information on how the measurement is performed, what results are presented, is described in detail in the subsection of this chapter “Spine balance measurement”.

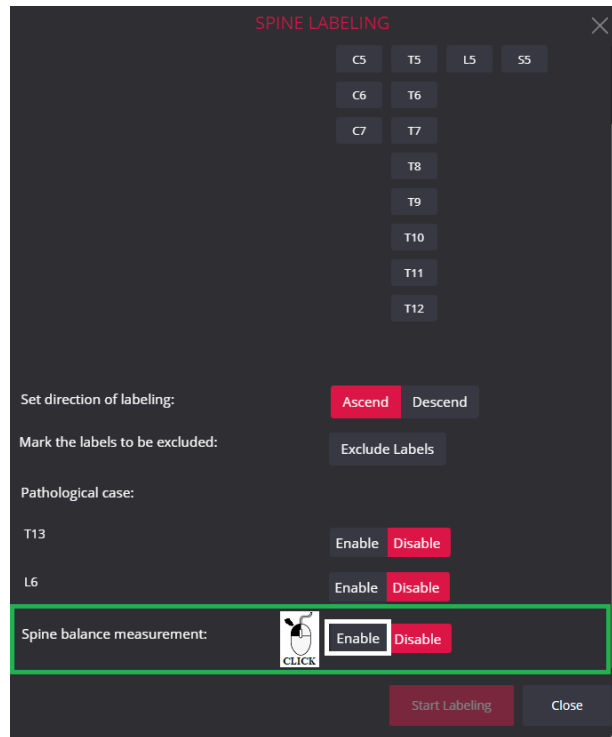

Figure 159. Enabling spinal balance measurement

NOTE! Selected values will be provided by default during the following step.

- to start the measurement, select “Start Labeling” in the action definition window or press the “Enter” button;

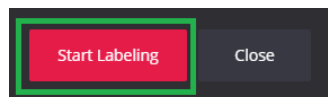

Figure 160. Beginning of the Spinal Labeling action

- the program closes the action definition window, marks the first vertebra in the image with a dot, nearby the dot includes labels and activates the next marking point with the label (the next dot is shown in a blue circle, the next label is shown in white);
- move the mouse cursor in the chosen direction and click the left mouse button on the middle of the next vertebra - the second vertebra is marked with a dot and a label is displayed nearby;

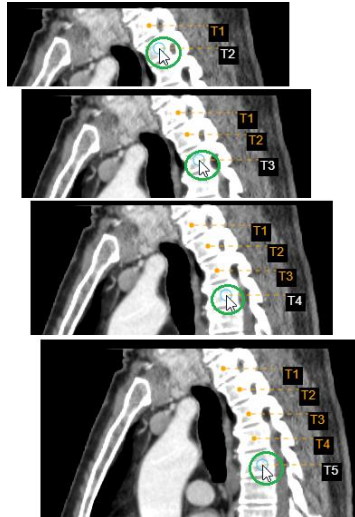

Figure 161. The course of the Spinal Labeling action

- repeat the action until you reach the last vertebra you want to mark, double-click the last point with the left mouse button;

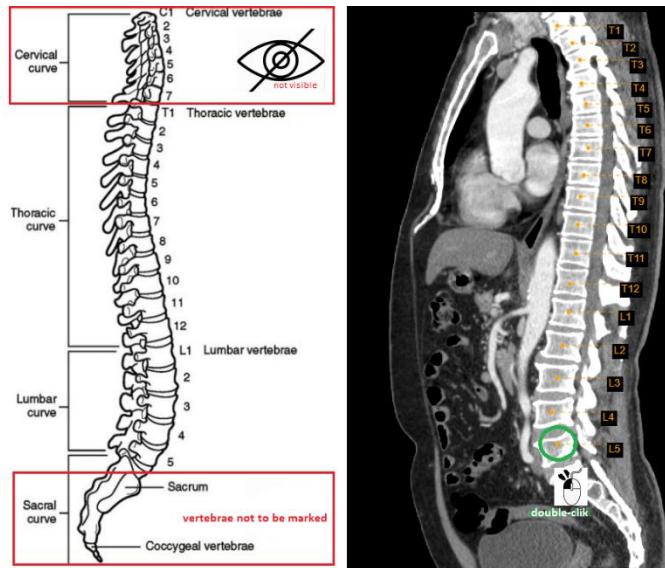

Figure 162. End of the Spinal Labeling action by double-clicking

- if there is no double-click with the left mouse button, the measurement ends with the dot with the last label;

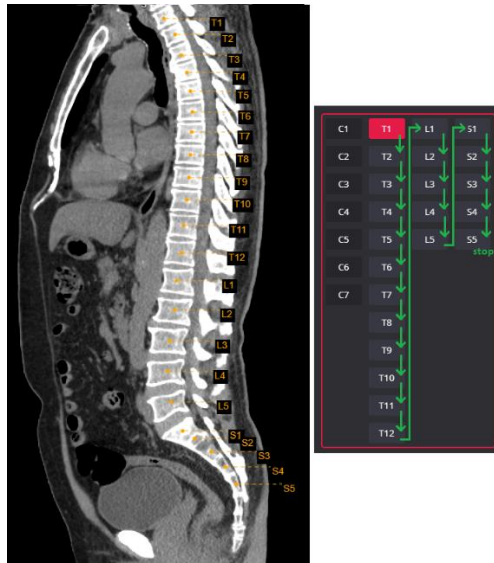

Figure 163. End of the Spinal Labeling action

- until the measurement is saved, the position of each point with the label can be changed:
 - place the mouse cursor over any of the measurement points and click the left mouse button once (1);
 - in the image, all points are marked with blue circles (2);
 - place the cursor on any blue circle, press the left mouse button (3) and without releasing the button move the cursor to any desired location on the image (4), then release the left mouse button;

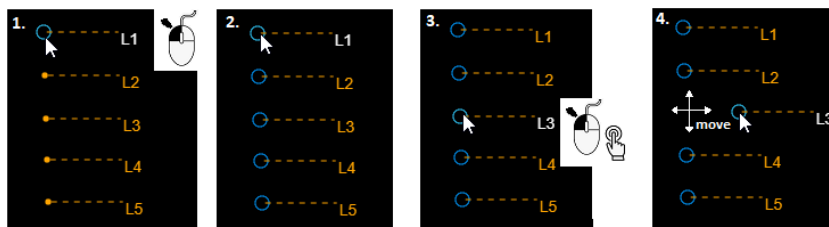

Figure 164. Changing the position of points in the Spinal Labeling action

- until the measurement is saved, the position of each label or all labels can be changed:
 - place the mouse cursor over the label which position you want to change and press the left mouse button;
 - the label text turns white;
 - without releasing the button move the cursor to any desired location on the image, then release the left mouse button;

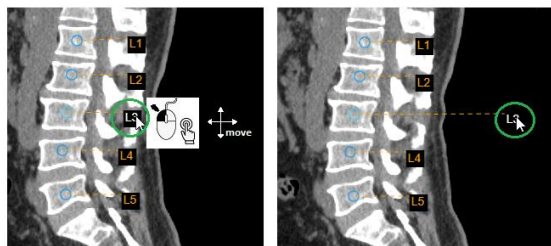

Figure 165. Changing the position of one label

- if you want to change the position of all labels in one step (1), place the mouse cursor over any label, press and hold the left mouse button for at least 5 seconds (2), then release the button - all labels will turn white (3), then again press left mouse button and without releasing button move the cursor to any desired location (4), then releasing the left mouse button (5);

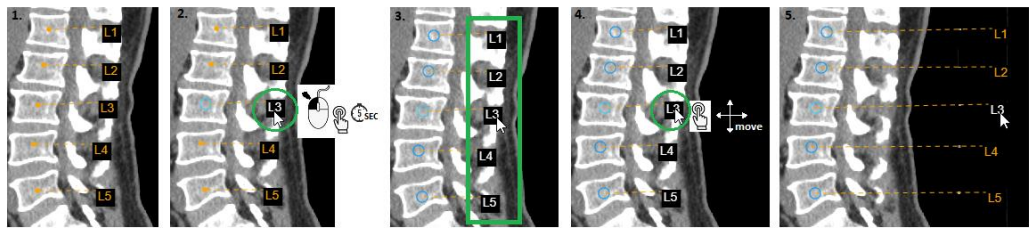

Figure 166. Changing the position of labels in the Spinal Labeling action

- until the measurement is saved, the position of the entire measurement can be changed:
 - place the mouse cursor over any of the measurement points, press and hold the left mouse button for at least 5 seconds (1);
 - then release the left mouse button - all points are marked with blue circles, all labels will turn white (2);
 - then again press left mouse button and without releasing button move the entire measurement to any desired location (3), then release the left mouse button (4);

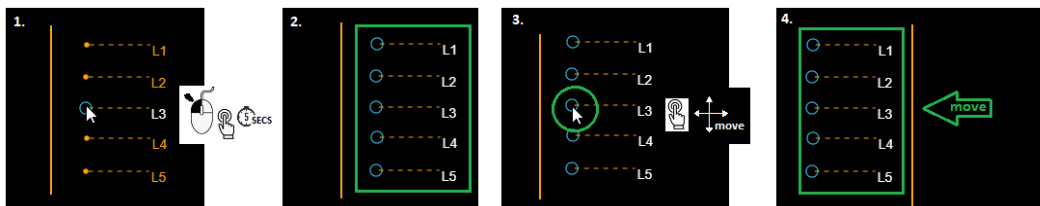

Figure 167. Changing the position of entire measurement in the Spinal Labeling action

Spine balance measurement

To perform a spinal balance measurement, enable the setting in the dialog at the beginning of the action.

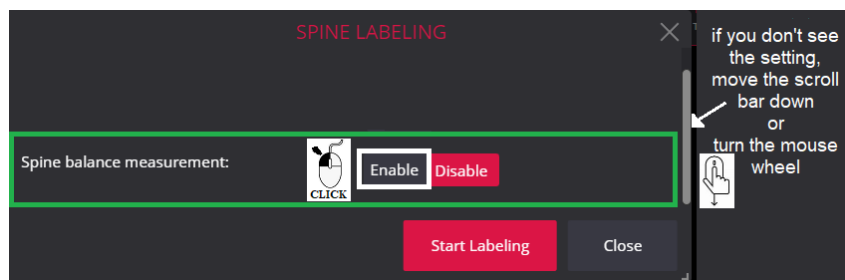

Figure 168. Setting of spinal balance measurement

After the user marks the C7 and S1 vertebrae, the system returns the result at the end of the spine labeling action

- calculated horizontal distance between C7 and S1 vertebrae,
- visually marked projection of vertebra C7 **+** at the height of the S1 vertebra,
- provides qualification based on the calculated distance:
 - Positive (if C7 is more than -2 cm to the left);

- Neutral (if C7 is less than or exactly 2 cm to any side);
- Negative (if C7 is more than 2 cm to the right of S1).

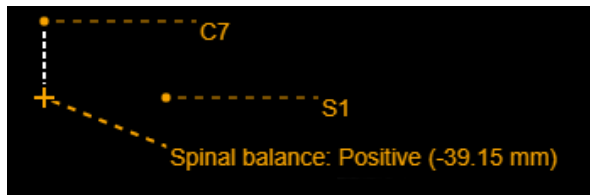

Figure 169. Measurement of spinal balance

NOTE! C7 and S1 vertebrae must be marked for the measurement to be performed. If at least one of these vertebrae is not marked, the measurement is not performed.

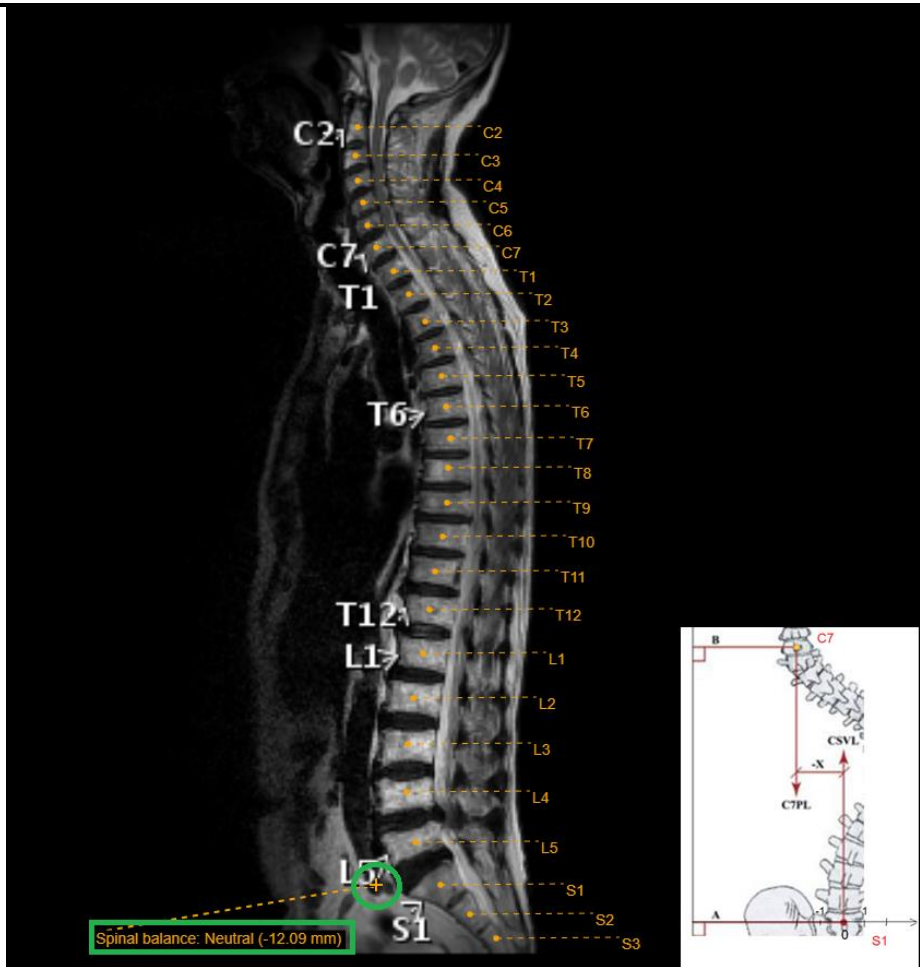

Figure 170. The result of spine balance measurement

After completing the marking of the vertebrae, the user has the option to change the position of the marking point. When changing the position of C7 and/or S1, the system recalculates the measurement result.

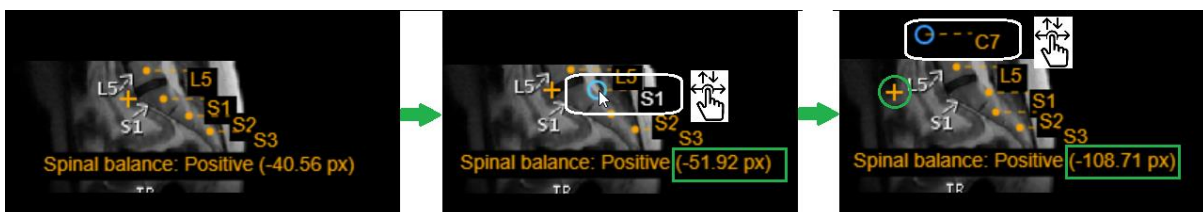
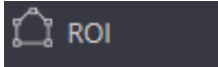

Figure 171. Recalculation of spinal balance measurement when replacing C7 and S1

Region Of Interest



The **ROI** (Region Of Interest) is the same as area measurement only without measurements.

Closed polygon and Repulsor

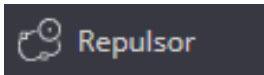
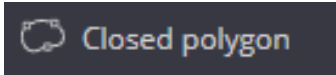

The **Closed polygon** is used to mark the region of interest. As in case of ROI, the area is marked by placing the points around it, but the points are connected with curved lines. To perform the closed polygon measurement:

- select **Closed polygon** tool in **Measure** menu;
- mark points around the area of interest by clicking the selected mouse button;
- the system connects the points as you place them;
- double click the selected mouse button at the last point to finish the measurement:

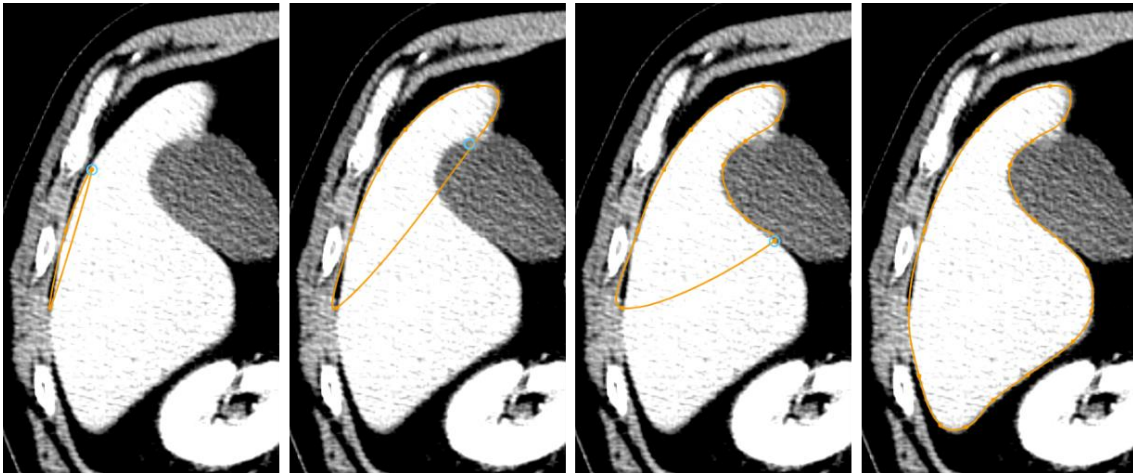

Figure 172. Marking region of interest with closed polygon tool

Until the **Closed polygon** is saved, you can move the whole measurement or adjust its contour as described:

- change the line by dragging any of the points;
- change the line by double-clicking any of the points and removing it;
- change the line by moving, adding, or removing points with Repulsor tool.

Select the closed polygon measurement you want to edit with Repulsor tool:

- select **Repulsor** tool in **Measure** menu;
- adjust the image scale and position, and click the selected mouse button near the line from the side you want to push;
- the system places the Repulsor tool on the image;

NOTE! The system automatically adjusts the Repulsor radius according to the distance from the line. You can change the radius by holding the CTRL button and scrolling mouse wheel. The minimum and maximum allowed Repulsor radius is calculated depending on image width.

- hold the selected mouse button pressed and drag the Repulsor tool towards the line;
- the system adjusts the closed polygon line when the Repulsor tool touches it;
- release the mouse button if you need to cross the polygon and push with Repulsor from the other side.

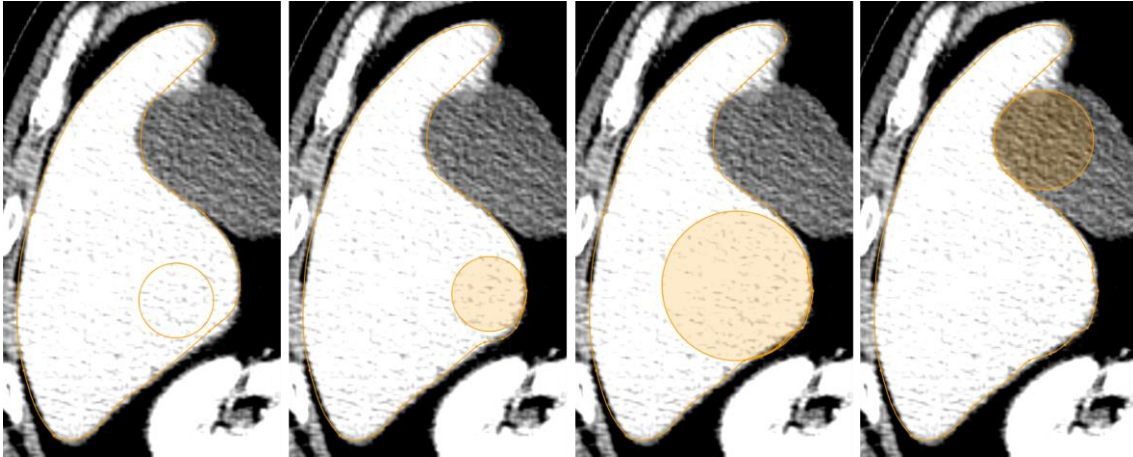
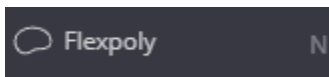

Figure 173. Adjusting closed polygon with Repulsor tool

Flexpoly



The **Flexpoly** is used to freely mark the region of the image for which the area is calculated at the end of the measurement. To perform a flexpoly measurement:

- select **Flexpoly** tool in **Measure** menu or press **N** on the keyboard;
- place the mouse cursor over the image, press the left mouse button and move the area without releasing the left mouse button;
- release the left mouse button after circling the desired image region;
- the program connects the start and end points in a straight line and calculates the area of the selected region;

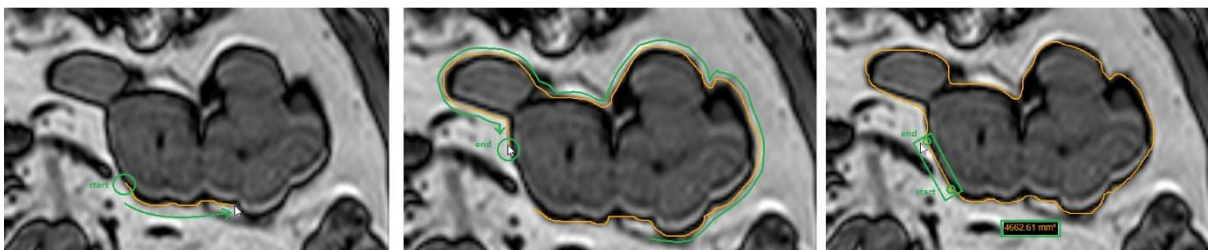

Figure 174. The Measure Flexpoly

- until the measurement is saved, the position of the flexpoly can be changed: place the mouse cursor, press the left mouse button without releasing the left mouse button, move it to the desired location, then release the left mouse button.

Pencil



The **Pencil** is used to mark the area of the image with a free drawing:

- select **Pencil** tool in **Measure** menu or press **B** on the keyboard;
- place the mouse cursor over the image, press the left mouse button and encircle the area without releasing the left mouse button;
- release the left mouse button after circling the desired image area;
- if you only want to place a point, place the mouse cursor over the image, press the left mouse button and release it; the result will show a point slightly larger than the line drawn with the **Pencil**;
- measuring Pencil lines or points can be displayed in different colors and different thicknesses than other measurements (how to change pencil color and thickness, see the "Settings" section);
- when you encircle an area or place a point, the measurement remains active, you can immediately encircle another area or place another point;

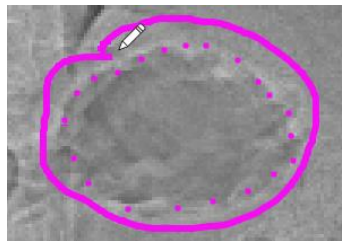

Figure 175. The Measure Pencil

- until the measurement is saved, the position of the encircle an area or place a point can be changed: place the mouse cursor, press the left mouse button without releasing the left mouse button, move it to the desired location, then release the left mouse button.



NOTE! The **Pencil** tool, unlike the other measurement tools, is not automatically deactivated. Click the mouse button on active **Pencil** measurement in toolbar to deactivate it.

Arrow

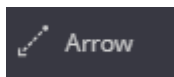

The **Arrow** intended for mark an area of interest in an image, a multi-frame, and a video viewports:

- select **Arrow** tool in **Measure** menu;
- place the mouse cursor over an image point or area of interest;
- click the left mouse button, the program will make a point with an arrow;
- without pressing the mouse button, move the cursor in the selected direction until the arrow line is the correct length, then click the left mouse button.

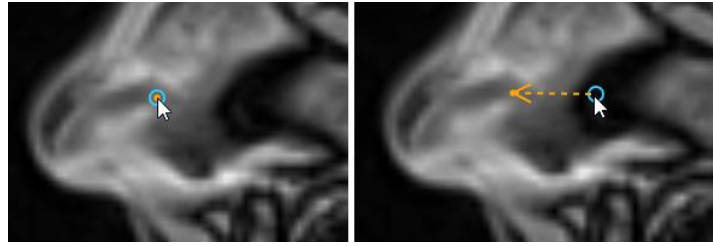

Figure 176. The Measure Arrow

- until the measurement is saved, the position of the arrow be changed: place the mouse cursor, press the left mouse button without releasing the left mouse button, move it to the desired location, then release the left mouse button.



NOTE! Measurement **Arrow** does not have the ability to add a text comment. If you need an arrow with a comment, use the Measurement **Text**.

Text annotations

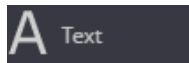

The **Text** tool is used to save the annotations of the measurements.

- select **Text** tool in **Measure** menu;
- to insert text box with arrow pointing to an object or image location, click the mouse button at the arrow end and drag the mouse to the place of text box;
- to insert only text box, simply click at the desired image place;
- an annotation text window with an arrow (if selected) will appear on the selected image place and the text entry field (white field) will appear at the bottom of the image;
- enter the text in the text entry field and press **Enter** button;
- the entered text will appear in the text box and the box will be resized accordingly.
- yellow arrow can be pointed to any place of the image by dragging its end point.
- yellow-border text window can be placed with a drag and drop motion anywhere on the image, for example, next to the measurement you want to add text to;
- double-click the text box for opening the text entry field and changing the entered text.



Figure 177. Text entry field



Time-Intensity Curve

Time-Intensity Curve

The time-intensity curve measurement allows for visualization of the lesions' behavior by plotting the ROI intensity values over time after the administration of contrast material.

NOTE! Measurement is most informative in studies that have phases.

To perform the **Time-Intensity Curve (TIC)** measurement:

- select **Time-Intensity Curve** tool in **Measure** menu;
- in the dialog window select ;
- the system creates the first line of the ROI record, the cursor in the active viewport changes to a circled cursor ;
- hover the cursor over the area of interest and click the left mouse button;
- the system immediately determines the intensity values in all phases at the point where the ROI point is located and displays it on a graph: intensity values on the Y axis, phase number on the X axis;

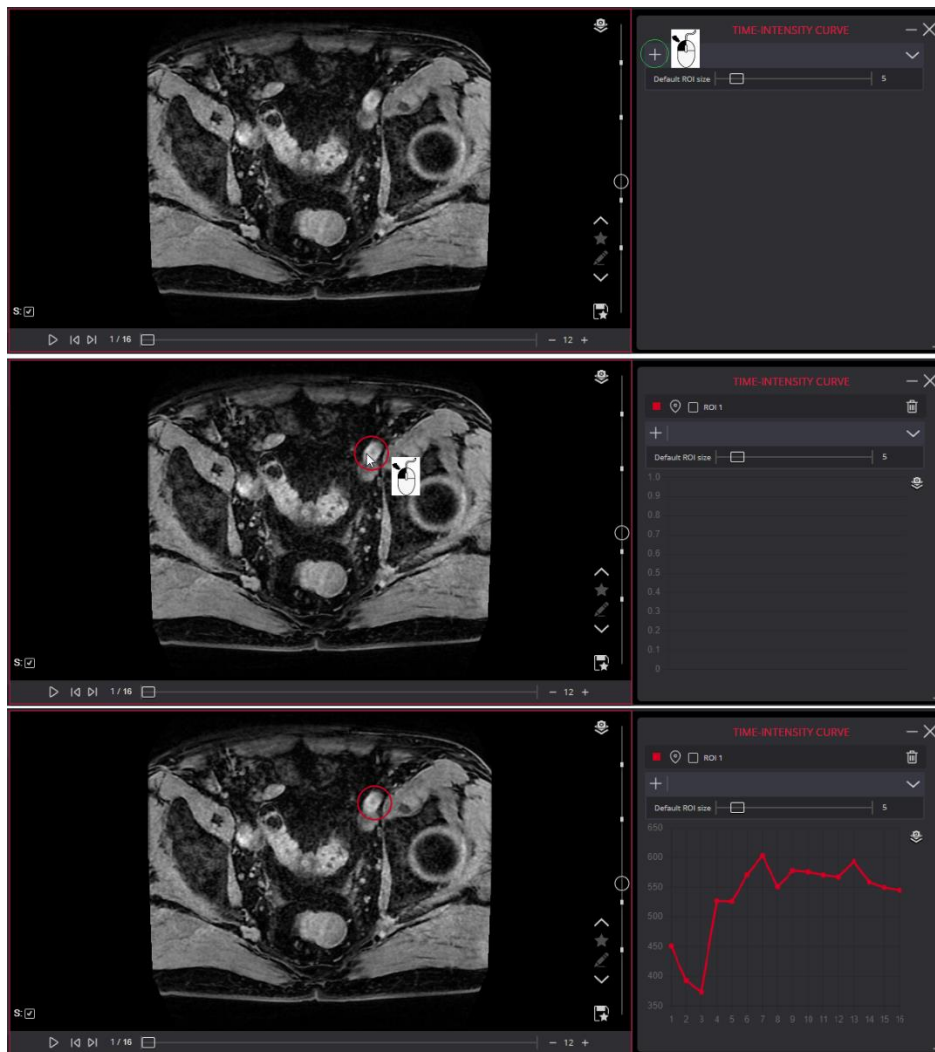



Figure 178. Time-Intensity Curve. The first ROI point

- if there are more regions of interest, repeat the steps: click , move the cursor to the region of interest and click the right mouse button;
- the system assigns a unique color to each new point and provides the name "ROI x";
- if the area of interest is poorly visible or not visible at all, it is possible to move to the next image in the series or to the next phase and then perform the ROI placement action;

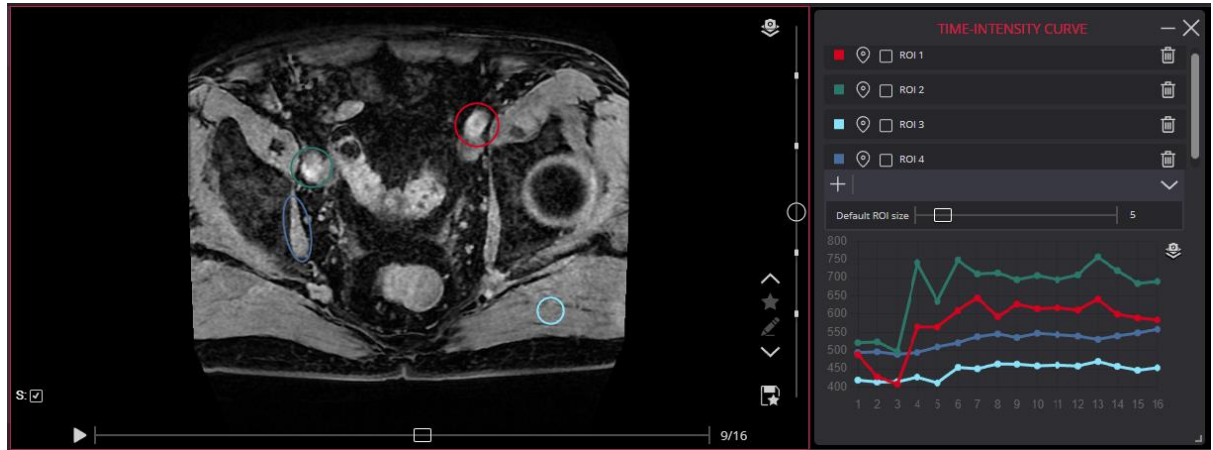

Figure 179. Time-Intensity Curve. With several ROIs

- if the ROI is not the required size, move the mouse until four corner points appear, select an outline or corner point and drag the cursor in either direction without releasing the left mouse button until the ROI is reduced or increased;

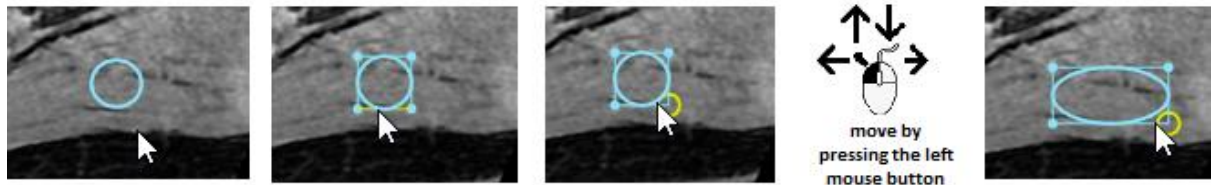

Figure 180. TIC. Changing the ROI size

- each new point has a default size that can be changed; the changed value is stored in local storage;

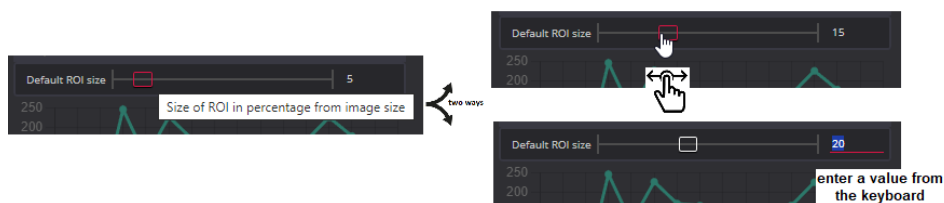

Figure 181. TIC. The default ROI size

- to change the position of the ROI, move the mouse cursor to the middle of the ROI until the circles appear, hold down the left mouse button, and move the mouse to the correct position without releasing the mouse button;

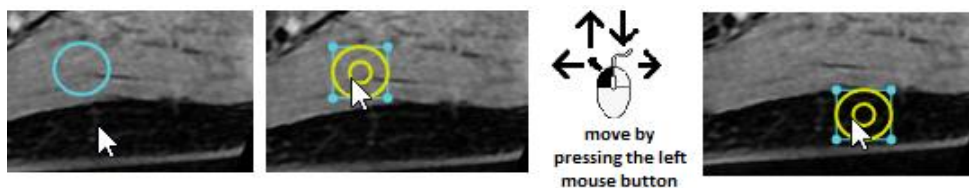

Figure 182. TIC. Change the ROI position

- the ROI can be rotated: hover the mouse, click on the corner point, press Alt and rotate without releasing the left mouse button;

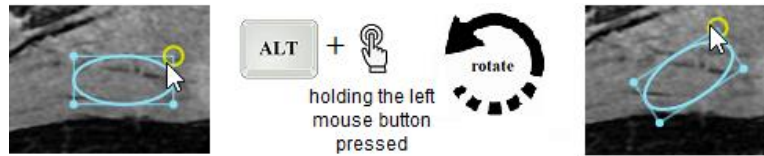



Figure 183. TIC. Rotate the ROI

NOTE! The graph shows the average intensity calculated for the pixels that fall within the ROI. If the size of the ROI is changed or the position of the ROI is changed, the graph is immediately redrawn according to the current values.

- to change the position or size of an ROI that you don't see in the open image, click  and the system will open the phase and the image in which the ROI is located;
- to see the change from the ROI control point instead of the absolute intensity values, mark the control point;

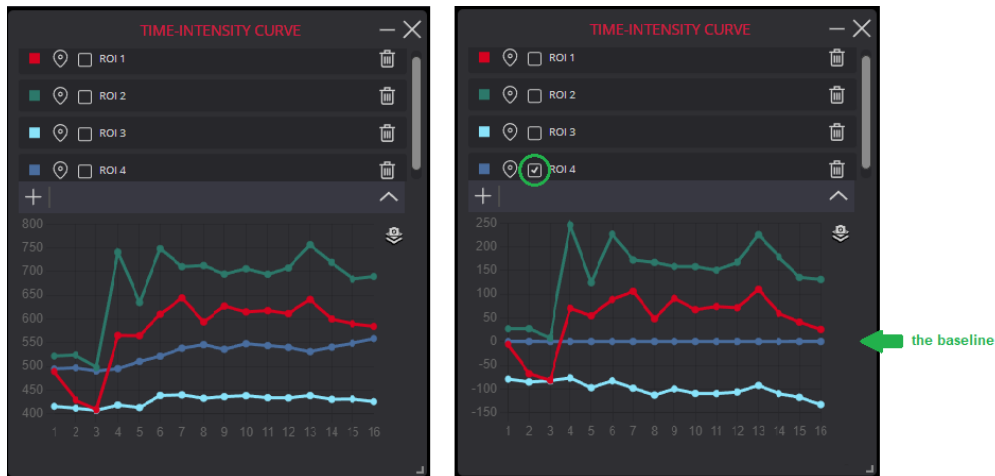

Figure 184. TIC. Change from control point

- the possibility to change the color, name or delete the ROI;

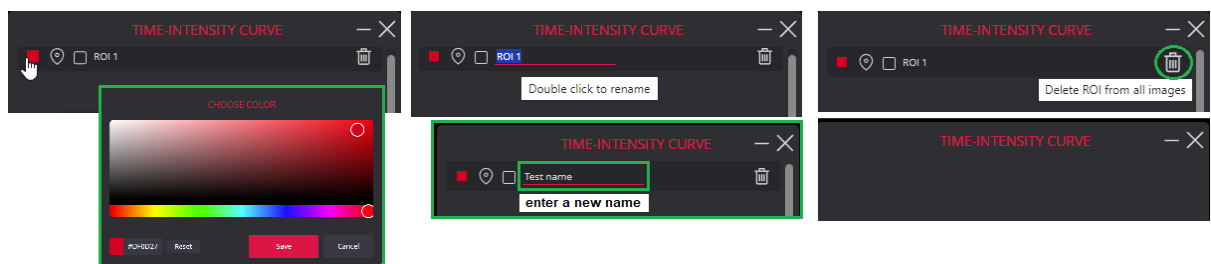



Figure 185. TIC. Change color, name, delete

- to save the graph as a secondary capture, click  near the top right corner of the chart.
- use the 4D slider controls to move to the next time point, or to start auto-play (see details in "4D tools. Show 4D slider").

NOTE! The Time-Intensity Curve ROIs and their information are not stored.

NOTE! **Time-Intensity Curve** does not work with video data type, with color images (RGBA or RGB data types) and JPEG transfer syntax encoded data. Samples_Per_Pixel attribute (0028,0002) is required to equal 1 for the measurement to work.

Continuous measurement

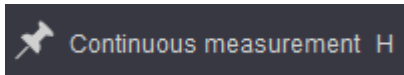

The **Continuous measurement** button is used to repeat measurements several times in succession:

- select one measurement in the menu list and click on "Continuous measurement";
- in viewport make the selected measurement as usual;
- after action the selected measurement remains active and the action can be repeated in viewport.

To turn off should press the **Continuous measurement** button one more time.

Continuous measurements have the possibility to turn on/off using a shortcut. By system value by default, the shortcut is "H". This value of shortcut can be change. For more information see in chapter "Shortcuts".

If the user turns on **Continuous measurement** it is saved in the browser's local storage and is applied the next time the dialog is opened.

Intensity

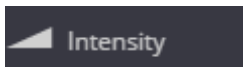

The **Intensity** button is used to measure the density of a CT image. To measure the density:

- select **Intensity** tool in **Measure** menu to activate the function: the highlighted icon indicates that function is activated .
- move the mouse cursor over the point you want;
- the density of the point (in Hounsfield units, HU) and its coordinates are displayed at the bottom left corner:



Figure 186. Intensity measurement

- click the activated **Intensity** menu once more to deactivate the function.

Show Angles

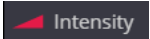
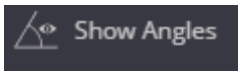

Use the **Show Angles** function to see the angles between any intersecting lines. To display the angle measurements:

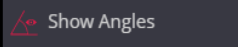
- select **Show Angles** tool in **Measure** menu to activate the function: the highlighted icon indicates that function is activated ;
- if **Show Angles** function is active, the angles between intersecting lines are displayed:

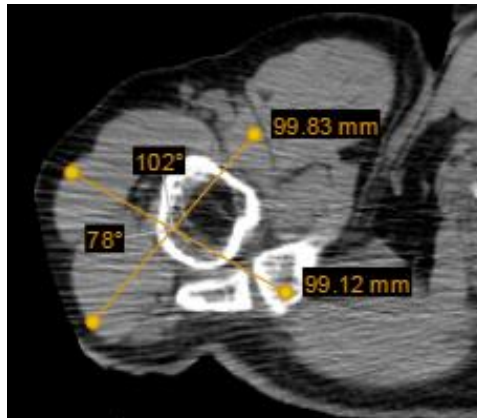
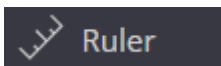

Figure 187. Angle measurement between intersecting lines

- Click the activated **Show Angles** menu once more to deactivate the function.

Ruler

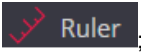

Use the **Ruler** function to see the ruler in the viewport. To see the ruler:

- select **Ruler** tool in **Measure** menu to display the ruler: the highlighted icon indicates that ruler is activated ;
- if **Ruler** is active, the rulers are displayed at the bottom and on the left of the viewport with images of the configured modalities:

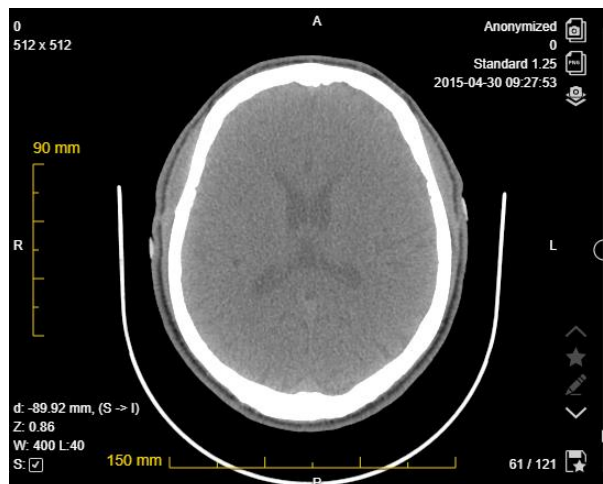
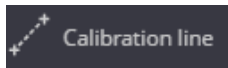

Figure 188. Ruler displayed in the viewport

NOTE! By default settings the Ruler is configured for CT and MR modalities. You can change the configuration in Settings.

- Click the activated **Ruler** menu once more to deactivate the function.

Calibration line



The **Calibration line** button is used to change the scale of measurement:

- select Calibration line tool in Measure menu;
- draw a line between two points at a known distance:

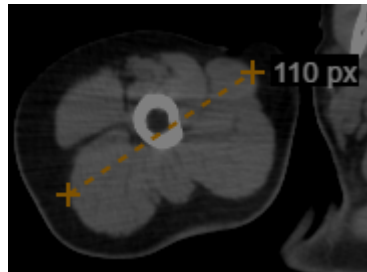

Figure 189. Calibration line

- indicate line length in millimeters in a pop-up window:

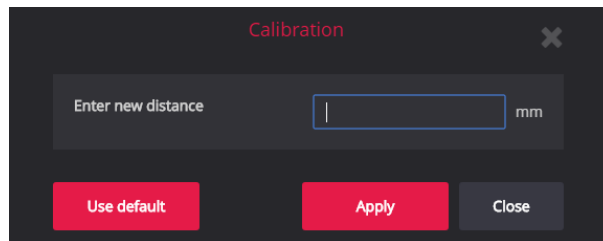

Figure 190. Entering the Calibration line length

- once the data is entered, click Apply button– data will appear on the left bottom corner of the screen:

CAL: 1 mm. = 0.5 px

Figure 191. Calibration ratio result

NOTE! Use default button resets to default calibration settings.

Delete measurements



The **Delete All** menu is used to remove all measurements of an active image at once.

To remove the measurements:

- select the image from which you want to remove all measurements;
- select **Delete All** in **Measure** menu – all measurements will be deleted from the active image.

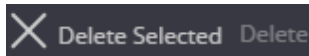

The **Delete Selected** menu is used to remove only selected measurements:

- select the image from which you want to remove some measurement;
- select the measurements on the image;
- select **Delete Selected** in **Measure** menu – the selected measurement will be deleted.

Save Annotation

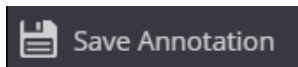

The **Save Annotation** menu allows to save the measurements for later usage and sharing. All measurements including text can be saved as annotation. See description how to save and to review saved annotations in section "Annotations".

Copy and paste measurement

Copy and paste measurement actions allows you to have the same measurement displayed in the same place on the different images, and so compare and analyze the difference among the images.



NOTE! Copy and paste is only available on the ellipse measurement and only with CT modality. For other measurements or other modalities, the copy button is not displayed.

The copy and paste measurement actions sequence is as follows:

1. The Copy measurement button  is displayed in measurement's label, if the copy and paste actions are available for this measurement. The measurements, that may be copied and pasted, are listed in subsections of this section.

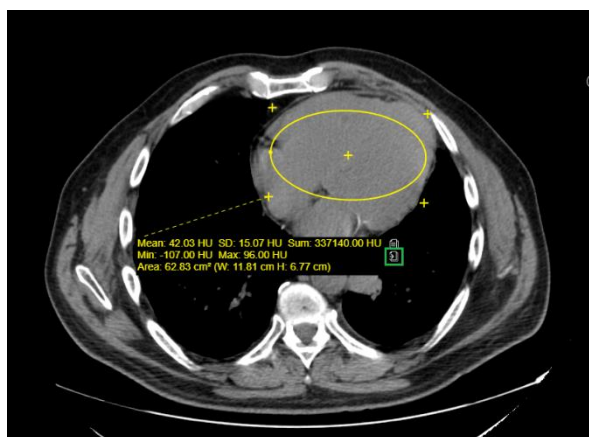



Figure 192. Copy measurement button

2. Clicking the Copy measurement button starts the copy and paste measurement actions sequence, and system performs the following actions:

- The copied measurement is highlighted;

- The Stop actions button  is displayed in label of the copied measurement instead of the Copy measurement button;
- The Paste measurement button  is displayed in all viewports with images, on which the measurement can be pasted.

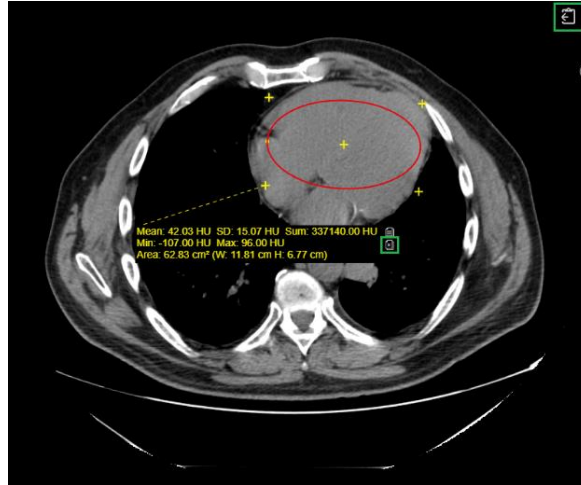

Figure 193. Stop and Paste buttons



NOTE! Only one Copy and paste measurement actions sequence is allowed at a time.

3. Clicking the Paste measurement button draws the copied measurement on the image:

- The pasted measurement is displayed exactly at the same place of the image where the copied measurement is displayed;
- The Stop actions button is displayed in the pasted measurement description.

4. You can locate the image for pasting the measurement in following ways:

- Locate the required image in the viewport with Paste measurement button by scrolling the series;
- Open image or series, and the system automatically displays the Paste measurement button in the viewport, if the measurement may be pasted on this image.

When done with pasting measurement, you can stop the copy and paste measurement actions sequence in following ways:

- By clicking the Stop actions button in the label of the pasted measurement;
- By starting a new copy and paste actions sequence;
- The system automatically stops the copy and paste measurement actions sequence when the last Paste measurement button is removed either because of changing Viewer layout, or because of opening another image in the viewport.



NOTE! Stopping the copy and paste measurement action sequence does not delete the pasted measurements.

When the copying sequence is stopped, the copy button is no longer displayed either on the ellipse being copied or on the ellipses that were placed before the action started.

To repeat the copying sequence for an ellipse created before the copying sequence was stopped, you need to select the ellipse and then the copy button will become visible again.

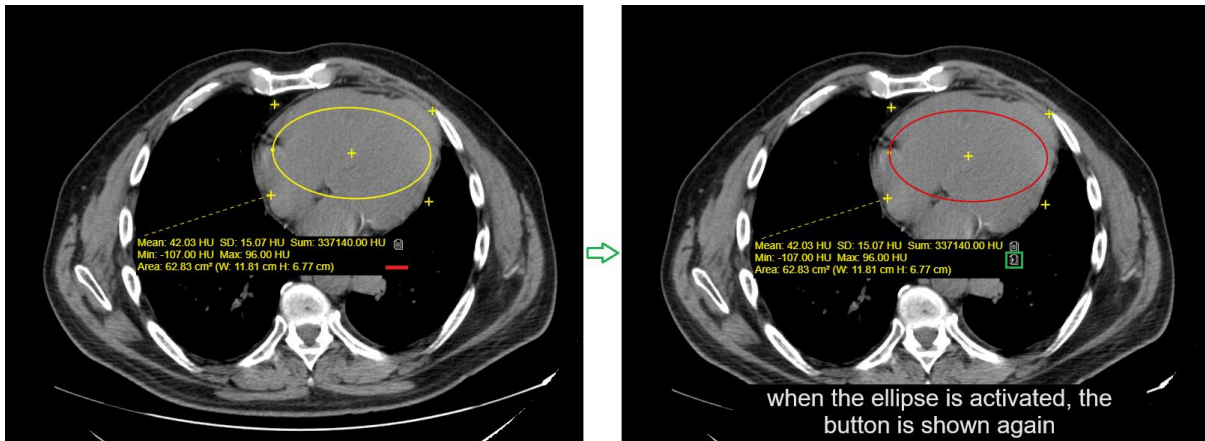

Figure 194. Repeating copying actions

Copy and paste ellipse

Copy and paste ellipse actions allows comparing the image statistics in different computer tomography series and images. The copied ellipse may be pasted on CT images, that have the same frame of reference identifier, patient orientation and scan direction.

The ellipse may be copied and pasted on CT images with fusions. In case of fused series, the PET image statistics is displayed in pasted ellipse label as well.

Copy measurement values to clipboard

The ability to **copy the value of measurements to the clipboard** allows you to work faster and prevent errors when manually writing down data.

Create a measurement and select the copy to clipboard icon.

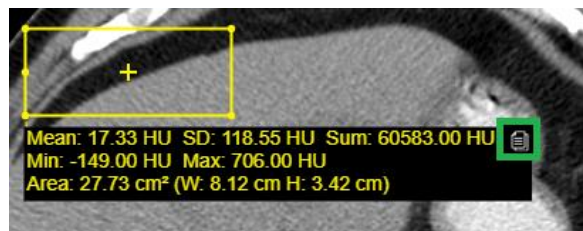

Figure 195. Copy measurement values to clipboard

When copied, the clipboard content may be pasted to any source.

If a measurement has more than one label, the copy icon will appear on each label.

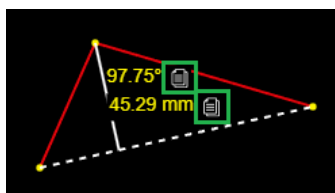

Figure 196. Copy measurement values to clipboard. More than one label

Annotations

Annotations can be created, saved, and viewed.



CAUTION! Annotations functionality may be disabled. Contact the system administrator to verify the configuration, if annotation functionality is missing.

To **create** and **save** annotation:

- Open the image that you want to annotate. In case of multiframe image, pause the playing and select the frame, which you want to annotate.
- Do the required manipulations: change windowing, rotate, pan, zoom etc.
- Add the measurements, text annotations.
- Save actual presentation state either with **Save Annotation** menu, or with **Quick save KO, PR** button, as described below:
 - select **Save Annotation** in **Measure** menu - save presentation state window will appear:

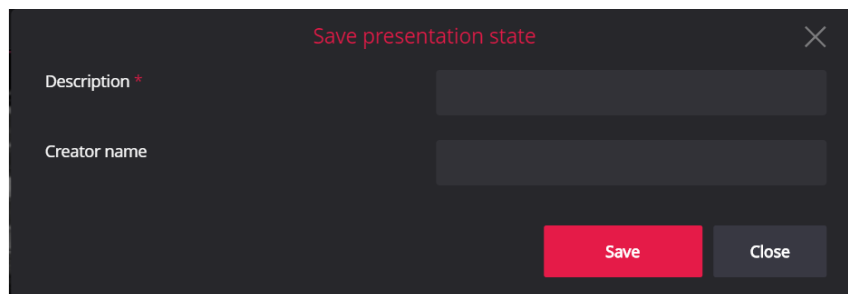

Figure 197. Save presentation state window

Enter the required description, creator name, if desired, and click **Save** button.

- Click the **Quick save KO, PR** button  at the bottom right side of the image. The current date and time are used as description of presentation state.



NOTE! Please notice, that **Quick save KO, PR** button initiates double action: saves the presentation state and saves key objects.

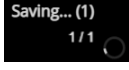
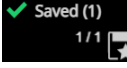

NOTE! To prevent the repeated clicks, system deactivates the **Quick save KO, PR** button and displays the notification about ongoing saving process on top of the button . Saving success notification  is displayed on successful saving process completion. The number in parentheses is the serial number of the image in the series.

- System saves annotation with the following information:
 - the date and time of annotation saving;
 - the annotation description, creator name, if entered;
 - any drawn measurements;
 - written text;

- manipulation actions performed.

NOTE! Annotation saving is implemented according to DICOM standard. The function is available only if the used study storage provides DICOM saving functionality.

NOTE! Several annotations may be saved for the same image or the same frame of the multiframe image. Each annotation is saved as separate series of PR modality.

CAUTION! Be cautious and verify the content before saving annotation. All the measurements and text annotation, including the zoomed outside of the currently viewed area, are saved and shared with other users viewing the study.

CAUTION! Be aware that system automatically opens the annotation after saving, as well as maintains the active measurement and text objects, that overlap with opened annotation.

NOTE! Active measurement is displayed on a single image, but on all the frames of the multiframe image. When saving, the annotation is assigned to the frame of the multiframe image on which the saving is performed.

Once the annotation has been saved, the annotation icon (pencil) will appear on image thumbnail:

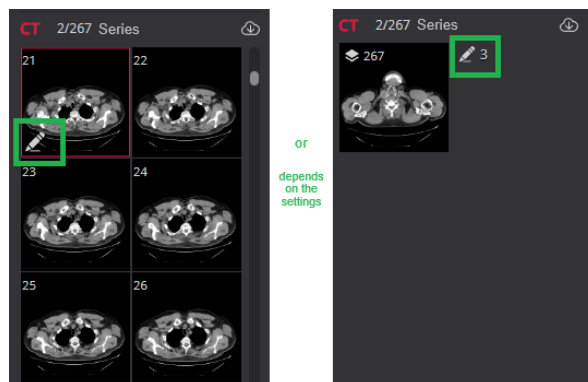

Figure 198. Annotation icon on image thumbnail

NOTE! You should change the default Auto open saved annotation setting, if you want the system to automatically open the last saved annotation when opening the image.

NOTE! Contact your system administrator, if You want to not auto open the annotations, that were generated and saved by the algorithms.

By default settings the annotation for the image should be opened manually. To **view** saved annotation:

- if thumbnails of the all series are displayed, drag and drop the annotated image (the one that has the annotation icon) to the viewport
- or use quick access controls (see section “Viewport toolbar”). - the active annotation button is displayed on the image in quick access controls group:

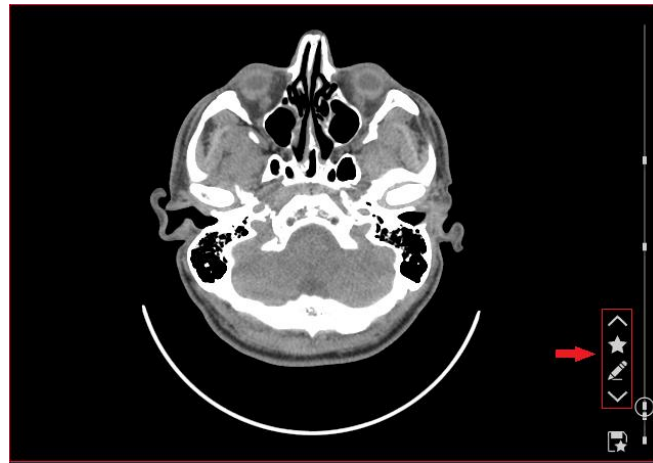

Figure 199. Annotation button on image

- move your mouse cursor to the **Annotation** button and click it. If there are several annotations, you can choose one or more to review from the list manually, or to open / hide all at once by selecting All/None option. Hold the cursor over the menu item to see the tooltip with annotation description, creator name, saving date and time, and information about saving, either through menu (PRESENTATION), or quick save button (KO_PRESENTATION):

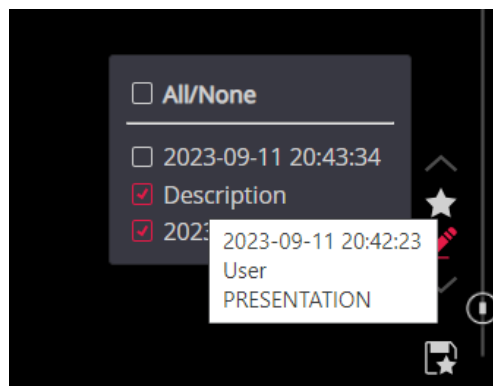



Figure 200. List of annotations and annotation description

NOTE! “YYYY-MM-DD hh-mm-ss” indicates annotations saved with **Quick Save KO, PR** button. When saved with **Save Annotation** from the menu it shows description.

- click the check near the annotation you have chosen to view and the saved annotation will appear on the screen with an information that has been saved previously:





Figure 201. View annotation.

 **NOTE!** Saved Annotations can only be viewed.

 **NOTE!** If multiple annotations are viewed, the system applies the visual and spatial transformations from the first selected annotation, or the last saved annotation in case all annotations are opened at once.

 **NOTE!** The measurements of all viewed annotations are displayed.

 **NOTE!** For multiframe images, the annotations may be viewed only if playing is paused. The list displays all annotations with a corresponding frame number, but annotation of only one frame may be viewed at a time.

 **NOTE!** If the annotation is opened, the check box is highlighted. Click the highlighted check box to hide the annotation. Or select option **None** to hide all viewed annotations and return to the image.

Key Objects



Key Objects concept is used in order to mark most interesting instances and save them for later review. Images, or frames of multi-frame images, marked as Key Objects, are stored in DICOM file of KO modality. Instances from different series of the same study can be stored in one Key Object selection. All instances marked as key objects are annotated with small star symbol.

 **NOTE!** Key objects functionality may be disabled in configuration.

To **create** key object:

- Open the image or frame that you want to include in key object.
- Expand the **Key objects** menu and select “**Mark image as KO**” from the list.
- The image marking as key object window will appear:

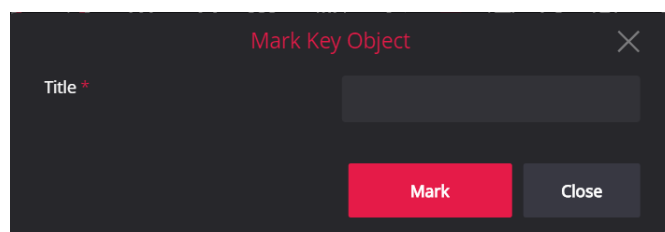

Figure 202. Mark image as key object window

- Enter the key object title or select the one from dropdown list of not saved key objects in the **Title** field, and click the **Mark** button.
- System adds the active image into selected key object. The unsaved key object (star filled with grey background) button is displayed on the active image in viewport and thumbnail. The key object title is displayed in extendable menu of **Key Objects** tool.

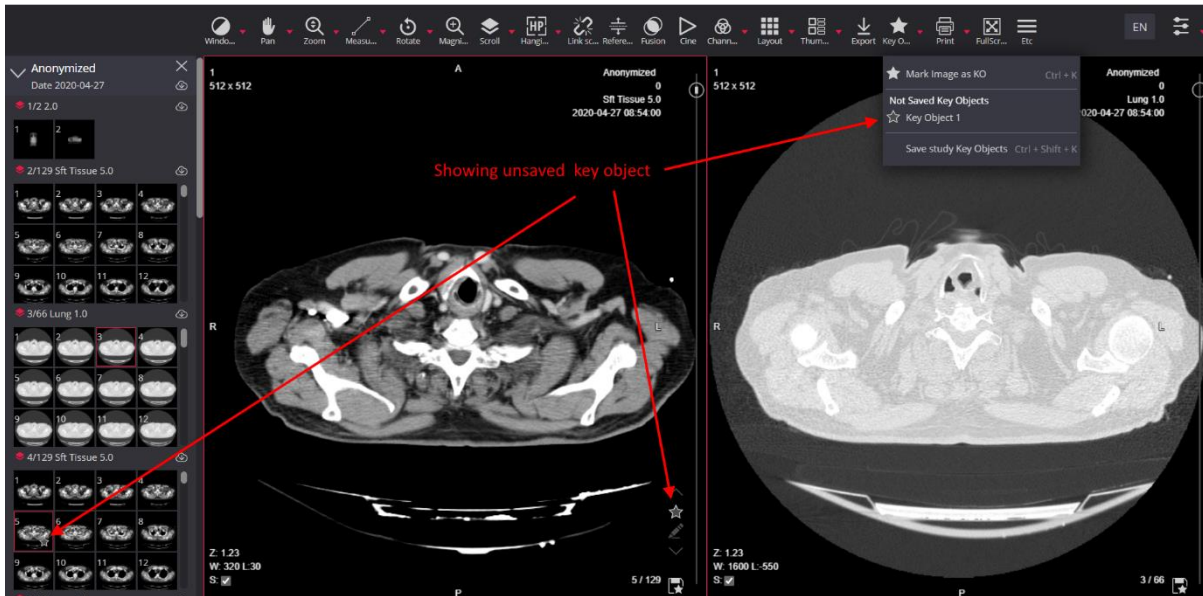

Figure 203. Not saved Key Object

NOTE! You can have several unsaved key objects at a time.

To **save** created (marked) key object:

- Expand the **Key objects** menu and select “**Save study key objects**” from the list. The key object saving window with all unsaved key objects listed will appear:

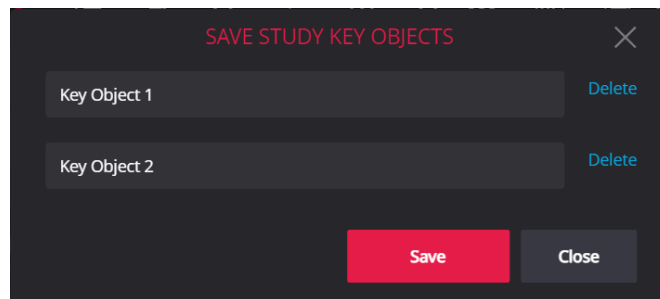

Figure 204. Save study key object window

- You can do the following actions in the window:
 - change the name of Key object by clicking the entry field and editing text in it,
 - delete the not needed Key object clicking **Delete** button on the right of the key object title,
 - After making the desired changes, save the Key objects by clicking the **Save** button.
- System saves the key objects with all the marked images and frames in it. The saved key object icon (star filled with white background) is displayed on the image in viewport and thumbnail. The key object title is displayed in Saved key objects group of extendable **Key Objects** button’s menu.

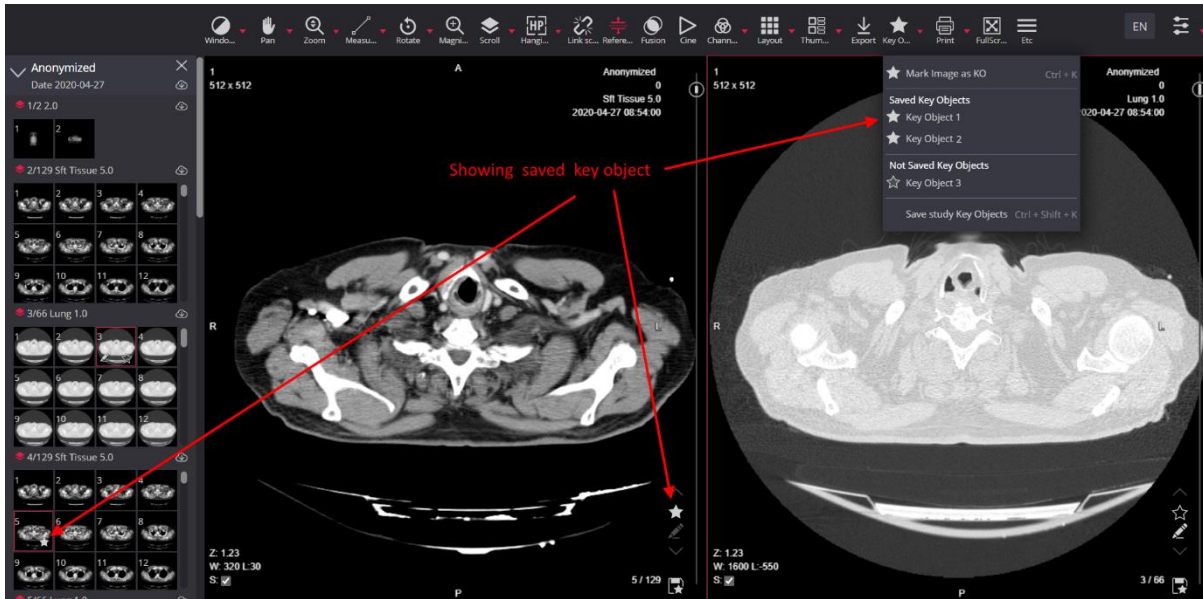



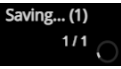

Figure 205. Saved Key Object

NOTE! Key object saving is implemented according to DICOM standard. The DICOM storage must accept C-STORE operations from MedDream. Alternatively, when using the DICOMweb integration, the STOW-RS method can be used.

You can use **Quick save KO, PR** button  at the bottom right of the image to save the current image or frame as key object. In this case, the current date and time are used as title of key object.

NOTE! Please notice, that **Quick save KO, PR** button initiates double action: saves the presentation state and saves key objects.

NOTE! Quick save can be used only one time per image or frame and saves key object only if the image or frame is not included in any other saved or unsaved key object.

NOTE! To prevent the repeated clicks, system deactivates the **Quick save KO, PR** button and displays the notification about ongoing saving process on top of the button . Saving success notification  is displayed on successful saving process completion. The number in parentheses is the serial number of the image in the series.

To **view** not saved key object or saved key object:

- Open the key object’s image in viewport. You can do this either by selecting the title of the Key object from the drop-down menu of the **Key Objects** tool, or by dragging a key object image, that is marked with star icon, from thumbnail bar to viewport, or with quick access controls (see section “Viewport toolbar”).

NOTE! Use the drop-down menu of the **Key Objects** tool, to see the key object’s images from several series of the study. If Key object, that contains images from several series, is opened from menu, each series is opened in a separate viewport, starting from the first viewport. Key object filter is

automatically activated in each viewport. If the number of series exceeds the maximum possible number of viewports, the warning is displayed.

NOTE! If Key object image is opened from thumbnail or with quick access controls, Key object filter is not activated. To activate the filter, expand the key objects filter menu by clicking the key object icon on the right of the image, and click the Key object title in filter menu.

- Scroll through the images of the activated key object with mouse as described in section “Scroll”.

NOTE! The scroll is performed only in one series.

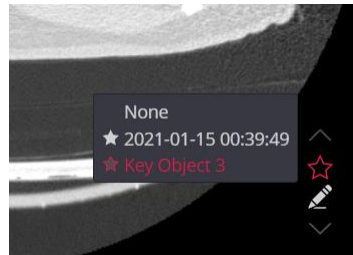

Figure 206. Selection of Key object filter in context menu

NOTE! Key object filter displays all key objects that contain the active image. The star with transparent background indicates that image is included in both, saved and unsaved, key objects. If filter is applied, the title of active key object and the star icon are highlighted.

Key Objects with annotation

The possibility to save an **key object with a link to the annotation**. This functionality provides that when the user performs a transformation on the image (for example, rotating the image or changing the windowing), saving the key object will be associated with saving an annotation which will be automatically opened when the saved key object is displayed.

NOTE! Functionality is activated in the settings.

The step flow is the same as described in the previous section, but when the system setting is activated, a additional check box is displayed in the windows.

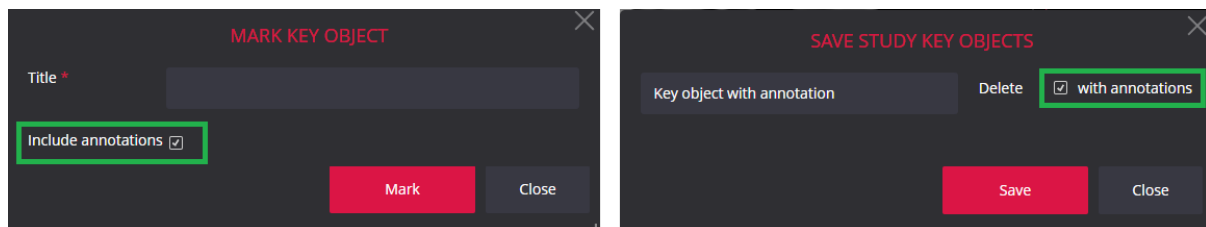



Figure 207. Key object with annotation

If the check box is unmarked, the key object will be stored without an annotation.

If the Quick KO, PR storage button  is selected, the key object will always be stored with an annotation.

Opening a key object that has been saved with an annotation automatically opens the linked annotation.

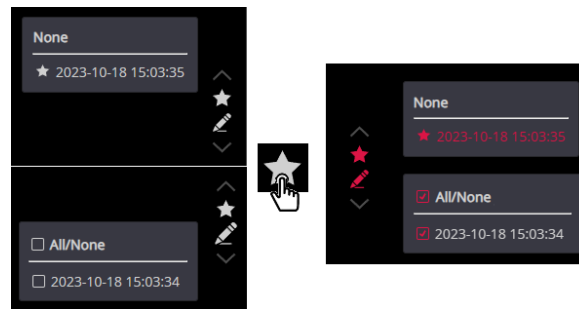

Figure 208. Opening a key object with annotation

An annotation that is saved with a key object is displayed in the list in the same way as normally saved annotations, and can be opened normally - without the key object.

Segmentation



Segmentation provides the tools for marking the regions of interest in medical images, saving them as RTSTRUCT, sharing them with other interested parties, or using artificial intelligence modules. The system also provides the user the possibility to measure and copy to the clipboard the statistics of the segments.

To start working with segmentation tools, expand the **Segmentation** menu in the main menu group, and select the tool from the list:

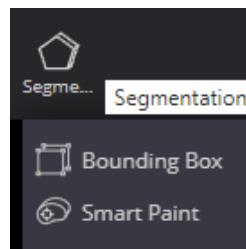

Figure 209. Segmentation button menu

NOTE! If you do not see the segmentation tool, please contact your system administrator. Any or all segmentation tools may be disabled in configuration, or by user rights.

NOTE! **Segmentation** may be done only on images of MR, CT, PET, NM, CR, MG, or DX modalities. In the studies, where volume can't be calculated (for example DX and MG modalities), is available for use only 2D tools.

CAUTION! Until not saved, the created, deleted or edited segments are held in program temporary storage and will be lost, if closing the Viewer or closing the study, that has segmentations with unsaved changes.

The system opens the Segmentation window, and activates the tab of the selected segmentation tool:

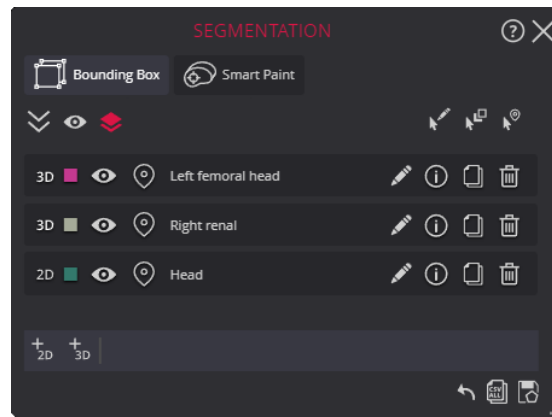

Figure 210. Segmentation window

Bounding Box



The **Bounding Box** tool allows marking the region of interest by drawing the bounding rectangular around it. The 2D bounding box option may be used to mark the region on one image. The 3D bounding box option may be used to mark the 3D region in series of images.

Create a new Bounding Box

2D Bounding Box

To **create** a new 2D bounding box segment:

- Open the image, in which you are going to mark the region.
- Open the Segmentation window and select the Bounding Box tool tab in it.
- Press the new 2D segment icon , which is displayed on the left of the tools bar at the bottom of the Segmentation dialog. The icon is highlighted and drawing is activated.

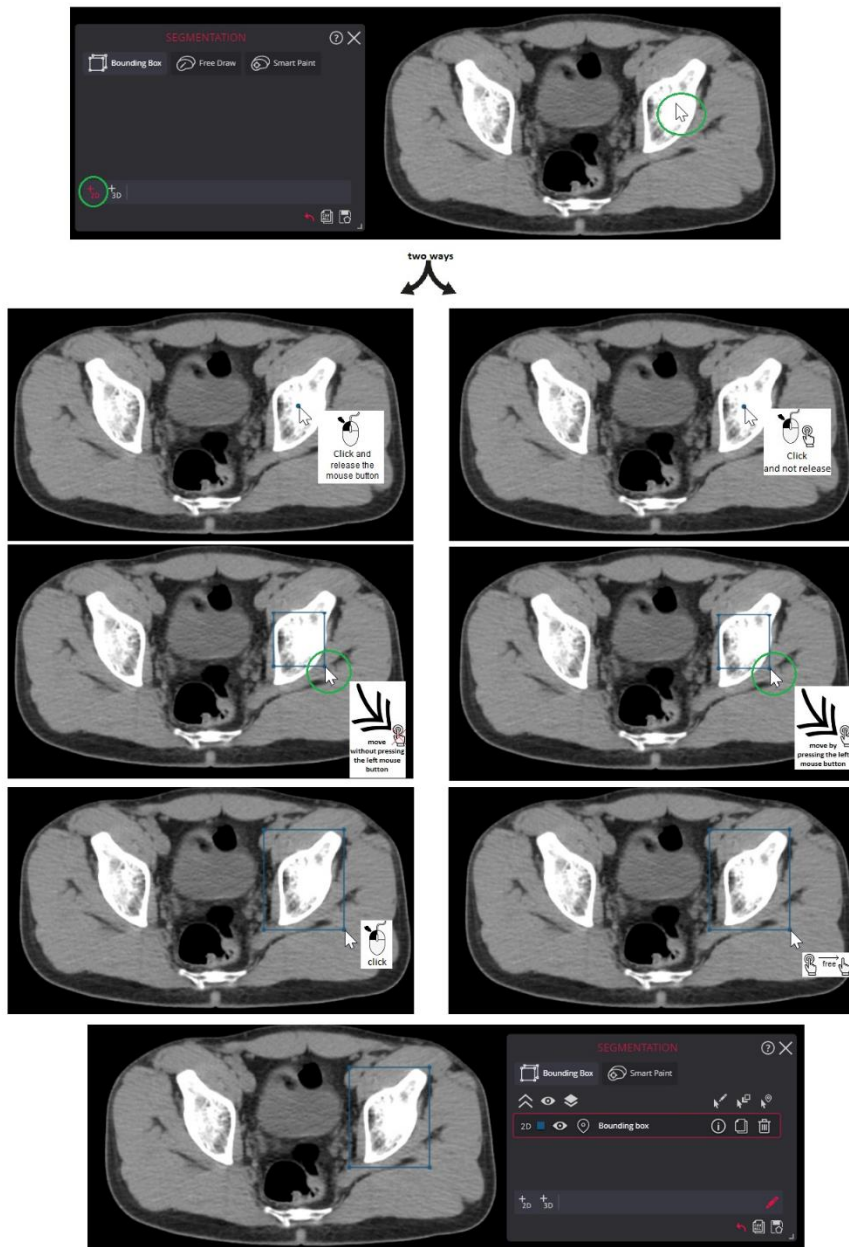

Figure 211. Creating a new Bounding Box

- Place the mouse cursor in the center of the region of interest. There are two ways to draw:
 - 1) place the mouse cursor in the desired location, press the mouse button, increase to the desired size, and click the mouse button again to complete the drawing;
 - 2) clicks the left mouse button, without releasing the mouse button, makes the desired size and releases the left mouse button;
- The system adds the **2D Bounding Box** segmentation to the **Bounding Box** tab of the Segmentation dialog. The default name and color, that were assigned to the segment, are displayed in the list and on the image.

How to change the name and color is described in a separate section.

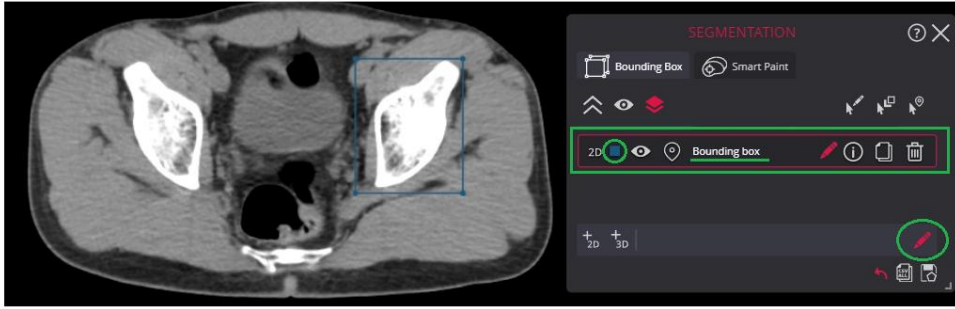

Figure 212. New 2D Bounding Box segment created

3D Bounding Box

To mark the volumetric region using the 3D **Bounding Box** tool, it is recommended to have the intersecting original or reconstructed series displayed in the viewports of the Viewer window for locating the region of interest:

- Select the orthogonal reconstructions from the MPR tool menu, if MPR reconstructions have not yet been developed.
- Adjust the Viewer layout and open the intersecting series in the viewports.
- Use reference lines or crosshair tools to locate the region of interest in the intersecting series.



NOTE! 3D **Bounding Box** segmentation does not work with MG and DX. There should be more than two images in the series.

To **create** a new 3D **Bounding Box** segment:

- Open the Segmentation dialog and select the **Bounding Box** tool tab in it.
- Open the series, in which you are going to segment the region. Scroll to the desired image, or use crosshair to locate the middle of the region of interest. The system expands the box to both sides from the current image.
- Press the 3D segment icon , which is displayed on the left of the tools bar at the bottom of the Segmentation window. The icon is highlighted and the drawing is activated.
- Draw the 3D **Bounding Box**. Place the mouse cursor in the center of the region of interest. There are two ways to draw:
 - 1) place the mouse cursor where you want to segment, press the mouse button, expand to the desired size, and click the mouse button again to complete the drawing;
 - 2) click the left mouse button, without releasing the mouse button, expand to the desired size and release the left mouse button.
- The system creates the 3D box based on the rectangle that was drawn. The 3 D box is expanded in a perpendicular direction to both sides of the current image, and the width of the box is calculated by dividing the perimeter of the rectangle by 4.
- The 3D Bounding Box and image plane intersection contours are displayed on all the images in the original or reconstructed series that intersect the 3D Bounding Box.
- The system will add the 3D **Bounding Box** segment in the **Bounding Box** tab of the Segmentation dialog. The default name and color, that were assigned to the segment, are displayed in the list and on the image.







Figure 213. New 3D Bounding Box segment created

NOTE! The saved 3D **Bounding Box** is linked to the images of the original series on which the 3D **Bounding Box** segment is created. If the 3D **Bounding Box** is created in the reconstructed series, the original series, that was used to create the reconstructed series, is used.

Edit Bounding Box

Activating editing mode

To work with an existing 2D/3D **Bounding Box** segment activate it by clicking

- 1) edit segment icon  on the row;
- 2) or first mark the row then press the edit segment icon  in the tools bar at the bottom of the Segmentation window;
- 3) or press on the keyboard “Alt + E” or click icon , the cursor icon changes from  to  in the viewport, hover over the segment you want to edit, the outline becomes highlighted, click the left mouse button.

The active row and edit icon are highlighted .

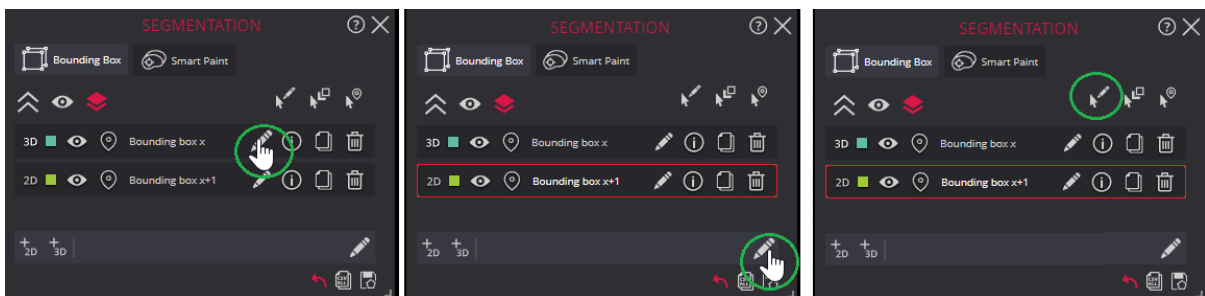













Figure 214. The edit mode for the Bounding Box

When done with Bounding Box editing, press the active edit icon  once more to stop the editing. The icon highlighting is switched off .

NOTE. The **Bounding Box** is linked to the original series, however it is possible to edit segment in all related images where the segment is displayed: in all intersecting original and reconstructed images.

The segmentation name **Bounding box 1** and color can be changed without editing mode.

It is possible actions before or after editing: to move the segment to the background , duplicate , delete , and undo the last action . When you have finished editing, select **Save** .

Also are possibilities to view measures , hide/show one or all segments , and hover to select  or open the image with selected segmentation .

These actions are common to Bounding Box and Smart Paint segmentation and are described in separate sections below.

Change the position

To move the **Bounding Box**, hover the mouse cursor over the center of the rectangle until the light blue circle appears indicating that the segment is selected, then press the left mouse button, drag the box to the desired position, and release the mouse button.

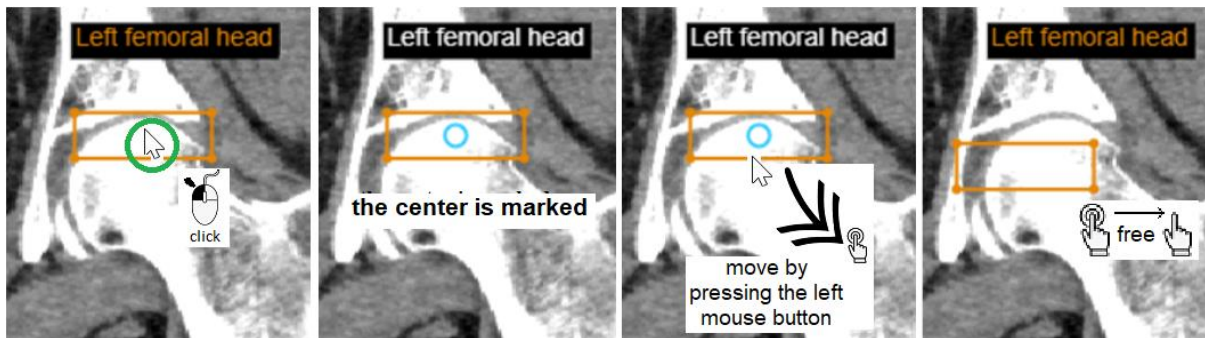

Figure 215. The Bounding Box moved to the center of the femoral head

Resize the Bounding Box

The **Bounding Box** may be resized by dragging the corner of the box, or by dragging the edge of the box. To resize the **Bounding Box**, hover the mouse cursor over the corner or the edge until the object is marked, then press the left mouse button, and, holding the button pressed, drag the corner or the edge. Release the mouse button, when the box reaches the desired size.



Figure 216. The Bounding Box is resized to fit the femoral head

Rotate the Bounding Box

To rotate the **Bounding Box**, hover the mouse cursor over the corner of the rectangle until the corner is marked, then press the ALT key and the left mouse button, and, holding the keys pressed, drag the corner. Release the mouse button, when the box is rotated to the desired position.

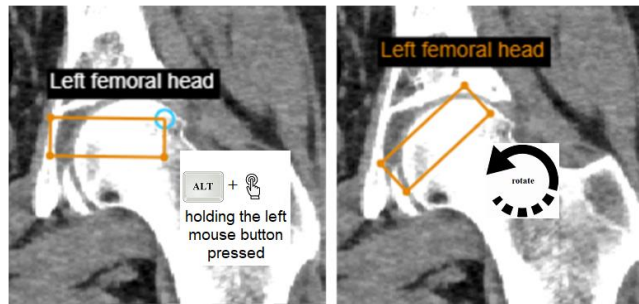

Figure 217. The Bounding Box rotated to better match the femoral head

NOTE! You can edit the 3D **Bounding Box** on any image in the original or reconstructed series, that intersects the box and has the tetragonal intersection contour. The changes apply to the whole box and all the contours of the 3D **Bounding Box** on the other images are automatically updated.

NOTE! The shape of the image and 3D **Bounding Box** intersection contour may vary from triangle to hexagon if a 3D **Bounding Box** is rotated in more than one plane.

NOTE! The 3D **Bounding Box** editing actions (move, rotate, resize) are not allowed in have other than tetragonal intersection contours.



Figure 218. The Bounding Box rotated to better match the femoral head

Smart Paint

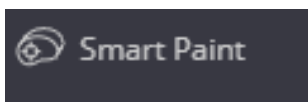

The Smart Paint tool allows you to mark an area of interest. A special feature of this tool is that when you select the smart tools, the paint seems to understand where you want to use it, usually selectively sticking to the organ of interest, avoiding other structures. The user has the possibility to use the tool in both 2D and 3D mode.

To start working with **Smart Paint** tool, expand the **Segmentation** menu in the main menu group, and select the tool from the list. The system opens the **Segmentation** window and activates the tab of the **Smart Paint** segmentation tool.

NOTE! Selecting any segmentation tool menu opens the same window, only activating different tabs.

Create a new Smart Paint

To create a **Smart Paint** segmentation, select on the left side of the window



The system creates a new segmentation, displays the result in a list of segmentation rows, gives it a unique name, and selects a unique color that the user can change. How to change the name and color is described in a section below.

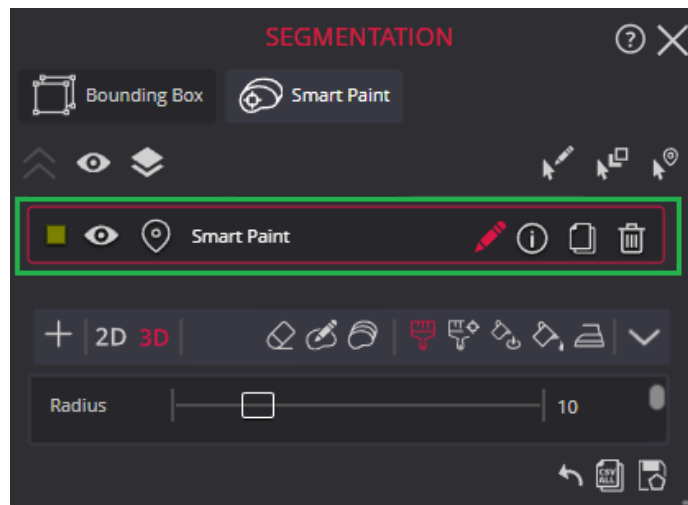

Figure 219. A Smart Paint segmentation

3D and 2D mode

When 3D **3D** is selected, segmentation is done from within a ball. The result of the horizontal section of the ball is a circle. When cutting the ball horizontally, the result of each cut away from the center is a smaller and smaller circle. As a result, the farthest images in the series will be colored less and less when colored.

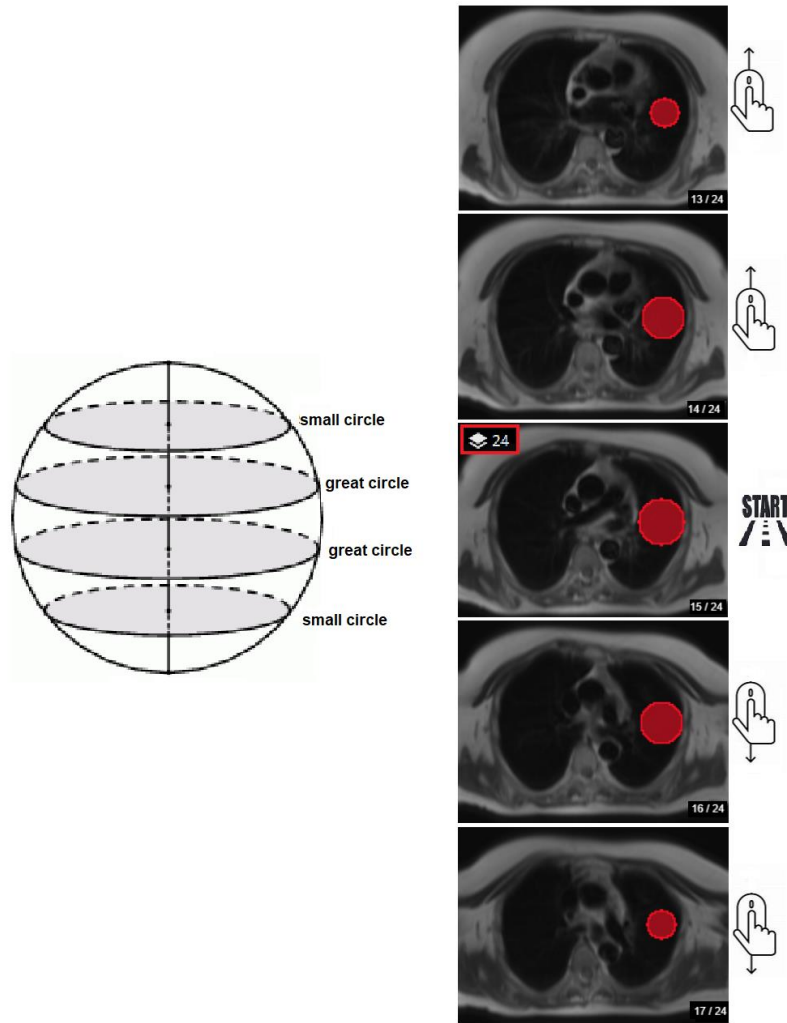

Figure 220. The Smart Paint 3D mode

When selected **2D**, only the active image in the series is segmented, the tool acts as a circle.

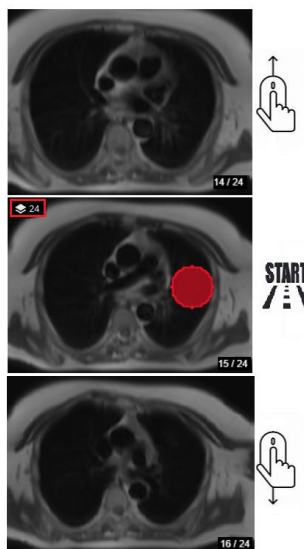





Figure 221. The Smart Paint 2D mode

Free draw tools

The **free draw** tools  allows marking the region of interest by drawing the contour on the image. The area inside the contour constitutes the segment. Several contours may be assigned to one segmentation. Drawing the contour inside another contour removes the overlapping area from the segment. Drawing contours on sequential images in the series allows for creating a volumetric segment.

 **NOTE!** The **Free Draw** segment may consist of multiple contours on the same or different images in the same series.

 **NOTE!** Free drawing tools are used only for 2D, single-image work.

Contour



- Draw the contour:
 - place the mouse cursor on the edge of the contour to be drawn,
 - press and hold the left mouse button,
 - draw the contour around the region of interest by holding the button pressed and dragging the mouse,
 - release the mouse button, when the drawing is finished.

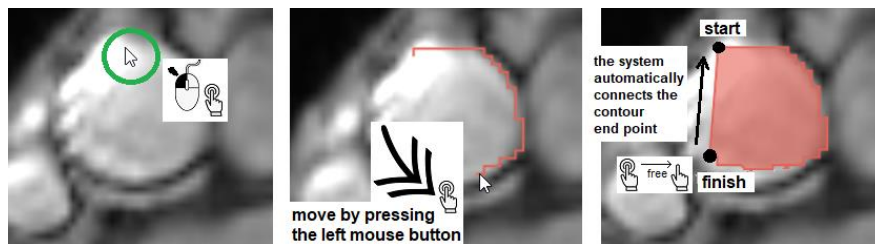



Figure 222. Draw the contour of Free Draw

Parameters: *Transparency.*

 **NOTE!** The system automatically connects the contour endpoints.

 **NOTE!** You can use viewer tools, like zoom, pan, and windowing that the contour can be drawn as accurately as possible.

Remove an inner area from a segment

To remove the inner area from the segment, draw the contour inside the existing contour:

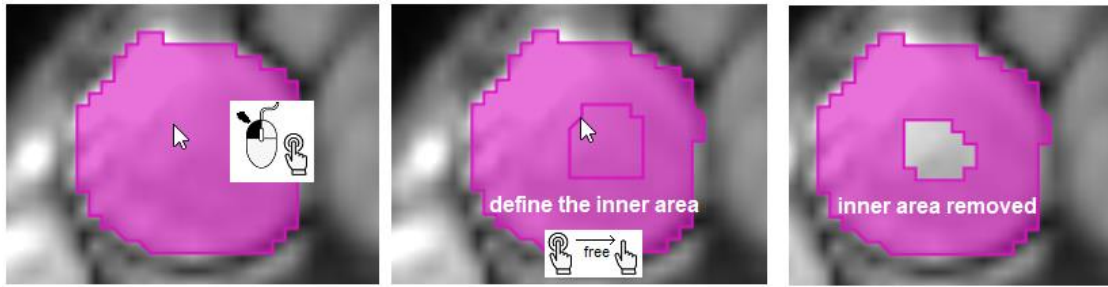

Figure 223. Removing the inner area

NOTE! The same result is achieved by drawing the inner contour first, then the outer contour around it.

Remove the area from the side

To remove an area from the side of the segmented region, press and hold the ALT key and draw the contour intersecting the segment border.

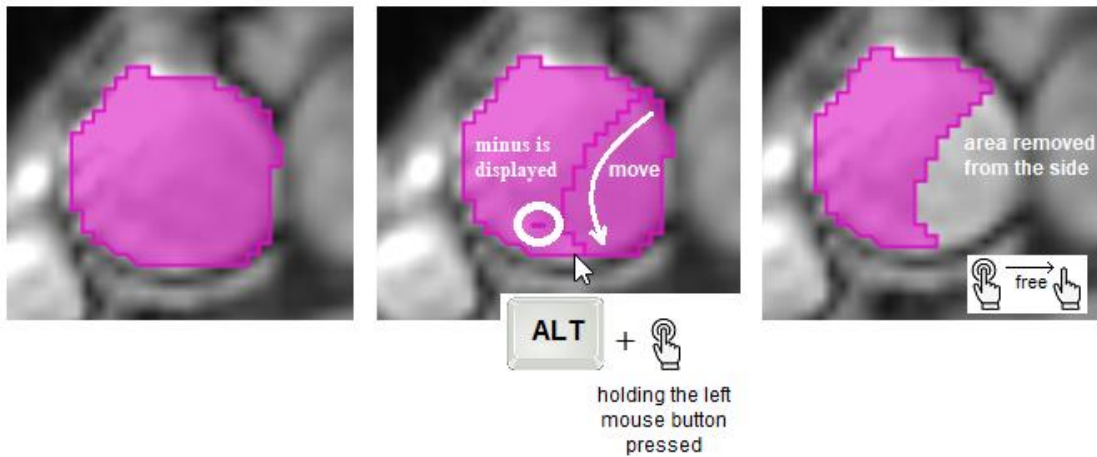

Figure 224. The area removed from the side of segment

Add additional area to a side

To add area to the side of a segmented region, press and hold the SHIFT key and draw the contour that intersects the segment border.

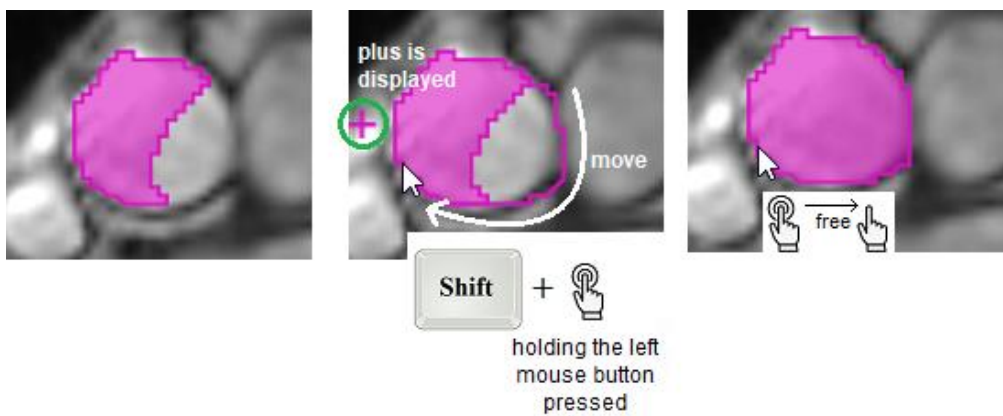

Figure 225. The area added to a side of the Free Draw

Add an additional region

To add a region to an active **Free Draw** segment, simply draw a new contour. You can draw a new contour either on the same image, or scroll in the series and use another image.

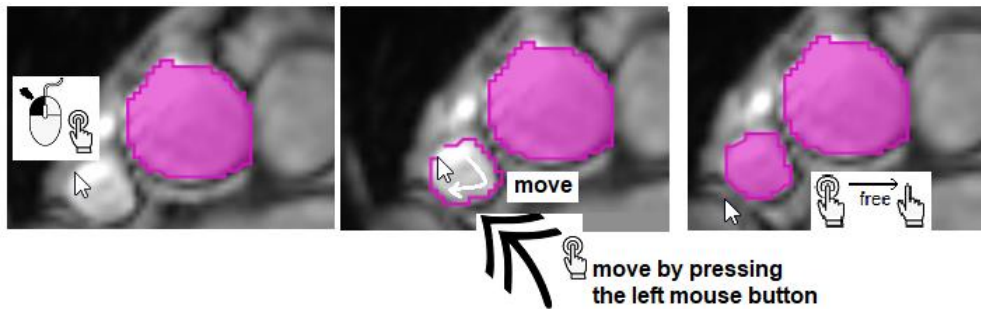



Figure 226. Adding a new Free Draw region

Erase tool

It is possible to erase the contour from **Free Draw** segment or to delete the whole segment. You can remove the

contour with the contour erase tool :

- Place the mouse cursor on the outline, until it is marked,
- Press the left mouse button,
- The marked contour will be removed.

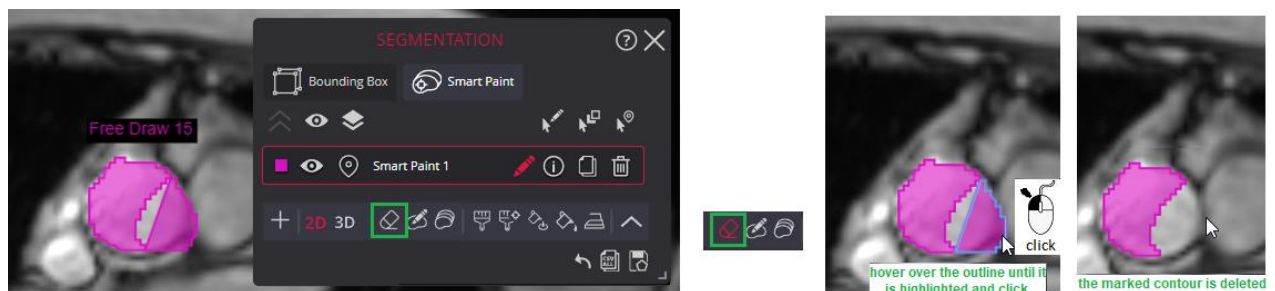



Figure 227. Removal of a section of a **Free Draw** segment

When the undesired contours are deleted, press the active Contour to erase icon  to deactivate contour erasing. The icon highlighting is switched off.

Parameters: *Transparency.*

Interpolation tool



The tool provides the ability to automatically fill intermediate images with segments between two, three or more user segmented images.

The user must first segment the images starting and ending with the region of interests (ROI) using the **c** . For example, ROI starts to be visible on slice 10 and the last fragment is visible on slice 30.

If the shape of the area of interest changes, then the intermediate slices must also be outlined using **Contour**.

The segmentation can be either a single area or, for example, a pair of areas. Segments with holes can also be available.

In the example below, the area of interest is outlined with the **Contour** tool in images 181, 185 (+4), 196 (+11), 201 (+5), 221 (+20). In these slides the shape of the RIO starts to change from the previous image.

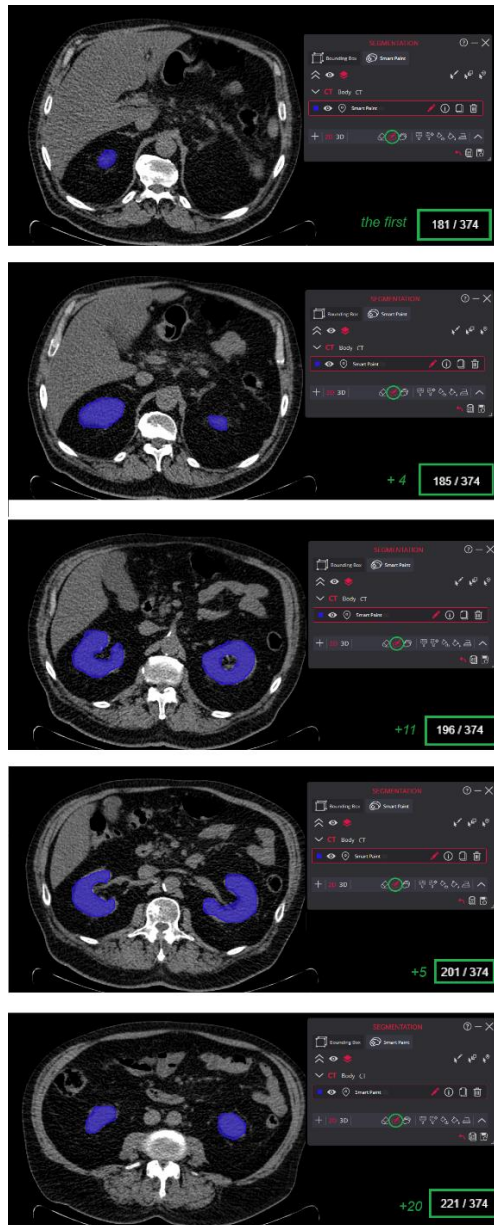



Figure 228. Preparing images for interpolation

After outlined the ROI in the first, last and if necessary, intermediate images, the user has to select interpolation action button . The system fills with segments intermediate images that have not been manually segmented.

The user has to review the result of the interpolation and accept or reject it.

Visually, the segments created by the user and those created as a result of the interpolation are different: the segments created by the system are more transparent and do not have a bold outline.

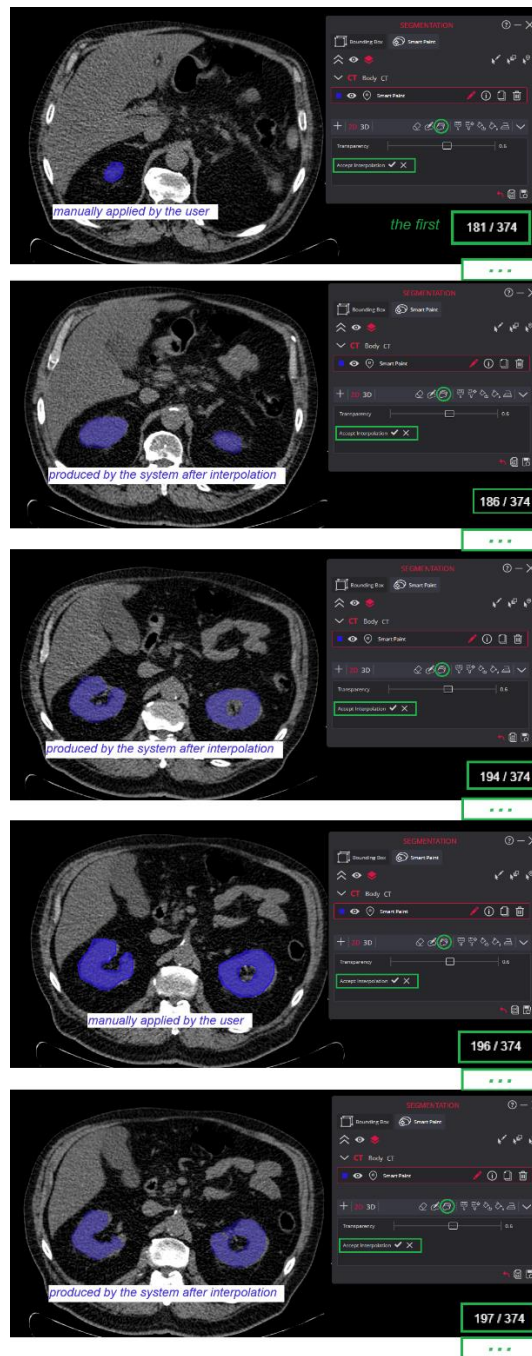

Figure 229. Unconfirmed interpolation result

If the result is not correct, the user must select the "Discard" button and additionally add segments in the intermediate slices.

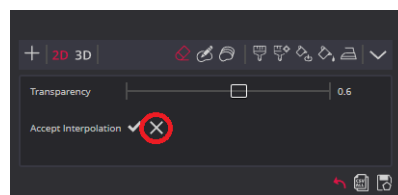

Figure 230. Rejection of the interpolation result

If the result is correct, select the confirmation button to complete the action. The system aligns the automatically created segments and displays them on a vertical slider.

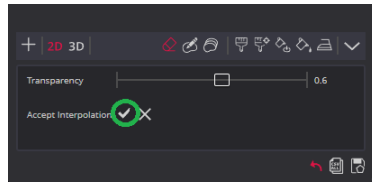



Figure 231. Accept of the interpolation result

If, after confirming the interpolation result, the user notices inaccuracies, the user is given the option to undo the interpolation step with  or the user can correct specific areas of the segment using other segmentation tools.

Smart tools



The user can segment - fill color or remove color - by selecting one of 5 tools

- Paintbrush;
- Paintbrush with Reference Pixel;
- Fill color;
- Fill Paintbrush;
- Smooth Edges.

 **NOTE!** When you activate a tool, its color changes to make it stand out visually in the toolbar.



 **NOTE!** All **Smart Paint** tools can be used in 3D and 2D modes.



Selecting any of the five tools activates the segmentation cursor - a circle of the variable radius with a marked center.



Figure 232. The **Smart Paint** segmentation cursor

 **NOTE!** When switching between 3D and 2D modes, the visual cursor is displayed in the same way, but the operation is different.

Paintbrush



Select the **Paintbrush** tool, place the cursor on the area you want to fill, click the left mouse button, and without releasing, swipe with the cursor, similar to using a brush.

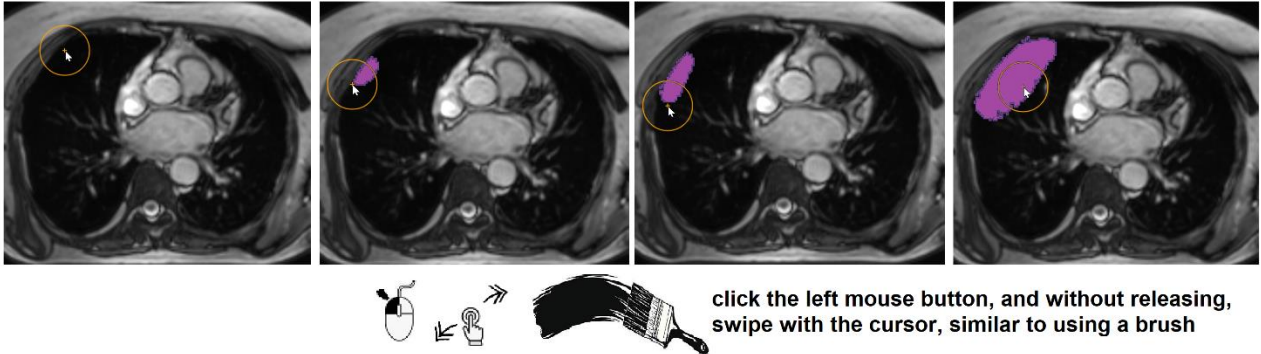

Figure 233. The Paintbrush

The tool analyzes each volume (3D) / image (2D) element that falls into the ball/circle. Calculates the inclusion probability based on:

- The distance of the element to the center of the brush
- The intensity similarity of the element to the center point.

When the calculated probability reaches a threshold defined by the calculation methodology, the area is included.

If you want to remove a volume/are, press the **Alt** key and repeat the process as you would when painting.

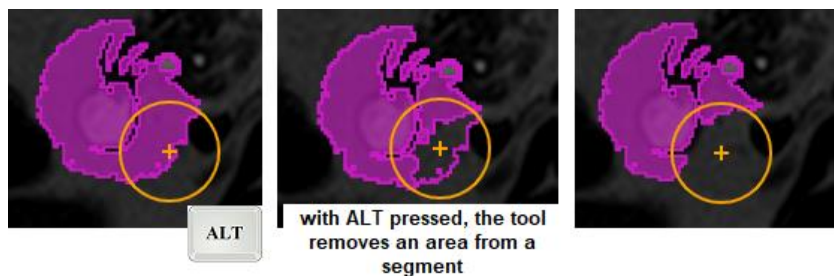

Figure 234. Removing an area with the Paintbrush tool

Parameters: *Radius, Sensitivity, Transparency.*

The parameters are common to all tools, described in a section below.

Paintbrush with reference pixel



Before using the tool, it needs to place a referent point:

- hover the cursor over the area where the fabric is most appropriate;
- increase or decrease the cursor radius to accurately select the pixels to align;

- press ALT and left mouse button;
- the system takes all the pixels that fall within the specified radius and calculates the average value;
- when a probability is calculated, it is based on the similarity to the calculated average intensity of the pixels (or voxels).

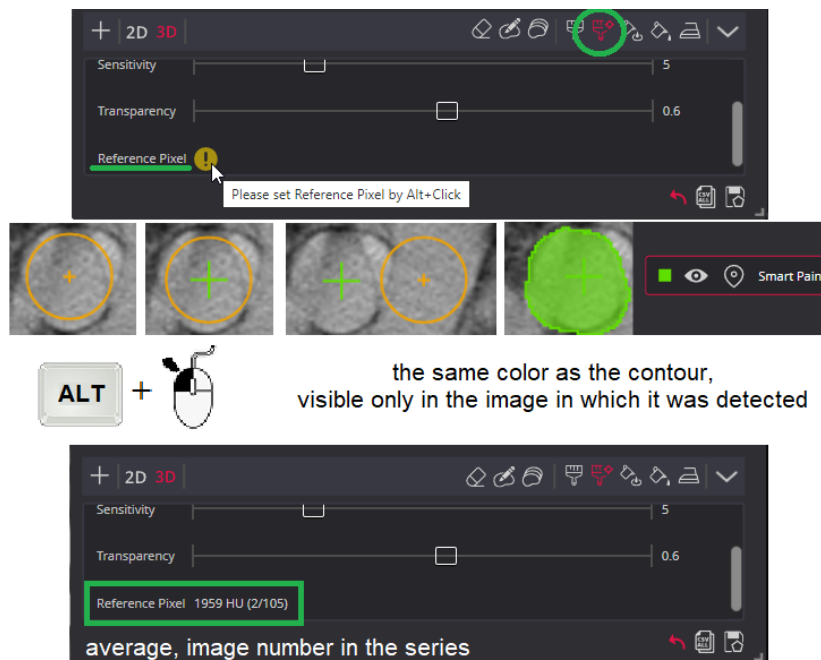

Figure 235. The Paintbrush with reference pixel

The probability is calculated and the result of which depends on:

- The distance of the element to the center of the brush (as well as using a Paintbrush tool);
- The similarity of the voxels to the calculated average (using a Paintbrush, compared to how similar the voxels are to the center point that moves with the Paintbrush).

Parameters: *Radius, Sensitivity, Transparency.*

Fill color



Select the **Fill color** tool, hover over the area/volume in the image you want to include:

- click the left mouse button
- or press the left mouse button and without releasing, drag the area you want to fill.

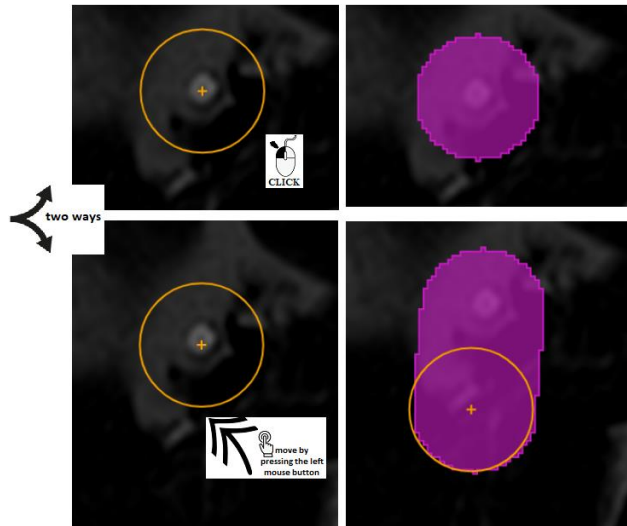

Figure 236. The Fill color

The tool does not analyze the image and includes the entire volume/area the cursor covers.

NOTE! The Fill Color tool does not apply a calculation methodology. The result of the tool is completely dependent on the user.

If you want to remove the segmentation, press the **Alt** key and repeat the process as you would when painting.

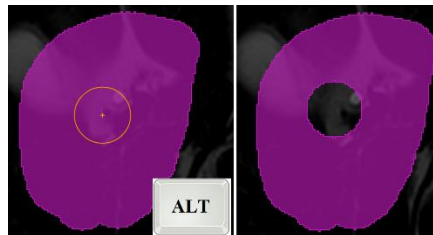

Figure 237. Removing an area with the Fill color

Parameters: Radius, Sensitivity, Transparency.

Fill Paintbrush



Select the **Fill Paintbrush** tool, hover over it, and click the left mouse button. If necessary, move the cursor to the next area and click the left mouse button again.

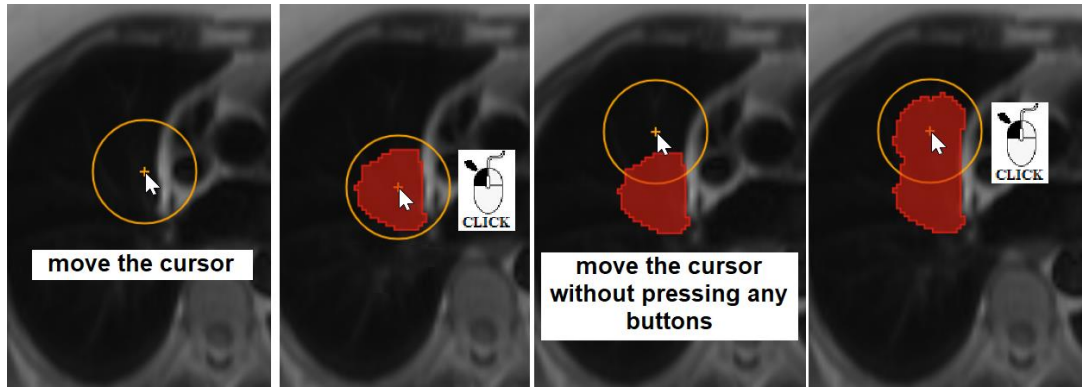

Figure 238. The Fill Paintbrush

Compared to the Paintbrush tool, the user does not need to swipe the mouse cursor, just one mouse click. The operation algorithm is the same as for "Brush": a probability is calculated, and the result depends on distance and similarity to the center point.

If you want to remove the included voxels, press the **Alt** key on your keyboard and repeat the process as you would when painting.

Parameters: *Radius, Sensitivity, Transparency.*

Smooth Edges



When segmenting noisy images, using the brush tool alone tends to produce segmentation results with jagged boundaries. Therefore, a smoothing operation is provided.

Select the tool, hover over it, and click the left mouse button.

If the result is still with jagged boundaries, then click the left mouse button again or move the cursor, then click the left mouse button.

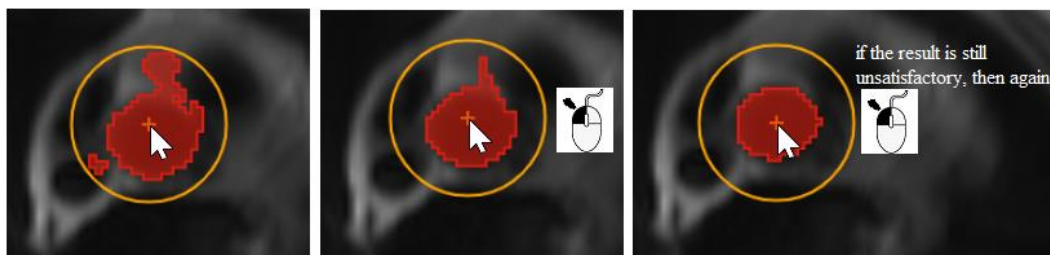

Figure 239. The Smooth Edges



NOTE! The tool does not function when pressing the left button and dragging the cursor without releasing a button.

Parameters: *Radius, Sensitivity, Transparency.*

Parameters of smart tools

The operation of all tools depends on the values of the parameters "Radius" and "Sensitivity". Improved visualization can be achieved by controlling "Transparency".

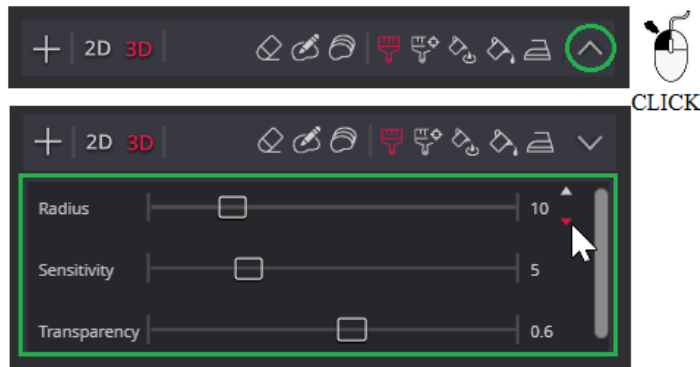

Figure 240. Parameters of tools

NOTE! If you do not see the parameters, then press the expand button right on the panels of tools.

NOTE! When editing multiple segments at the same time, you can set different parameters for each of them.

Radius

By increasing the operating **radius**, the segmentation algorithm processes a large amount of data, resulting in a larger volume/area segmentation. Reducing the radius also reduces the amount of data processed, but the user can target the tool more accurately.

Radius can be changed:

- a) by pressing ALT and rotating the mouse wheel: rotating forward will increase the radius, back - will be smaller;
- b) in the tool parameter area changing the value by scrolling with the mouse;
- c) by increasing/decreasing the value with the arrows  (the arrows become visible when you move the cursor to the right of the numeric values).

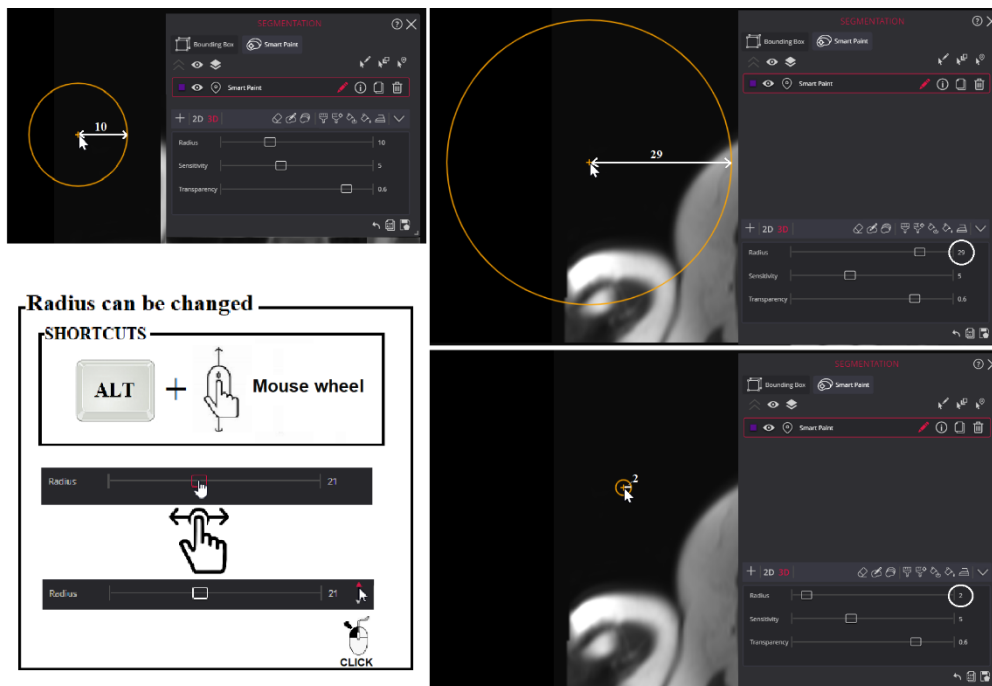



Figure 241. Radius

- d) Other shortcuts, if such were assigned by the administrator or user; you can find out the values by choosing .

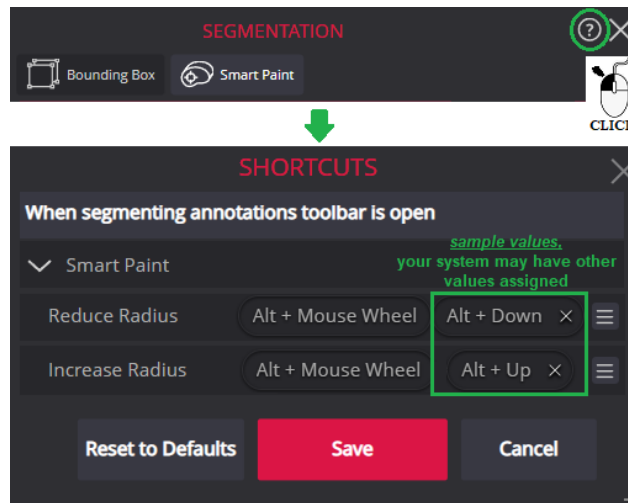



Figure 242. Changing radius with assigned shortcut

Sensitivity

The **sensitivity** parameter for the operation algorithm indicates how much the analyzed volume/area element must be "similar" to the center or reference point. If the parameter value is high, only practically overlapping elements are segmented in the result, and if reduced to 0, all volume/area elements will be colored, even if they are not similar.

When you change the sensitivity parameter, a second circle is visually displayed in the cursor circle. The smaller the inner radius of the inner circle, the higher the sensitivity. When the minimum or maximum sensitivity value is reached, one circle is visually visible.

Sensitivity can be changed:

- by pressing Shift and rotating the mouse wheel: rotating forward will increase the sensitivity, back - will be smaller;
- In the tool parameter area changing the value by scrolling with the mouse;
- By increasing/decreasing the value with the arrows  (the arrows become visible when you move the cursor to the right of the numeric values).

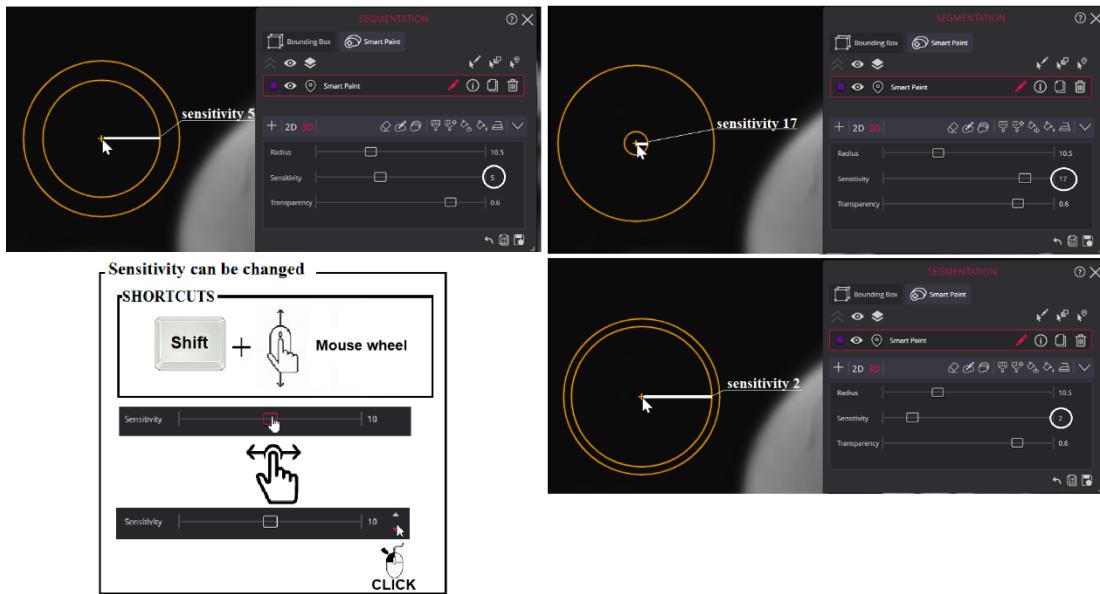





Figure 243. Sensitivity

- d) Other shortcuts, if such were assigned by the administrator or user; you can find out the values by choosing .

Transparency

Controls the transparency of the segmentation fill color. If it is difficult to see the edges of the organ through the paint layer, you can change the color transparency:

- a) Fully transparent **ALT + H**;
- b) In the tool parameter area by changing the value by scrolling with the mouse;
- c) By increasing/decreasing the value with the arrows   (the arrows become visible when you move the cursor to the right of the numeric values).

Reducing the transparency of segmentation color is useful for judging the correctness of current segmentation.

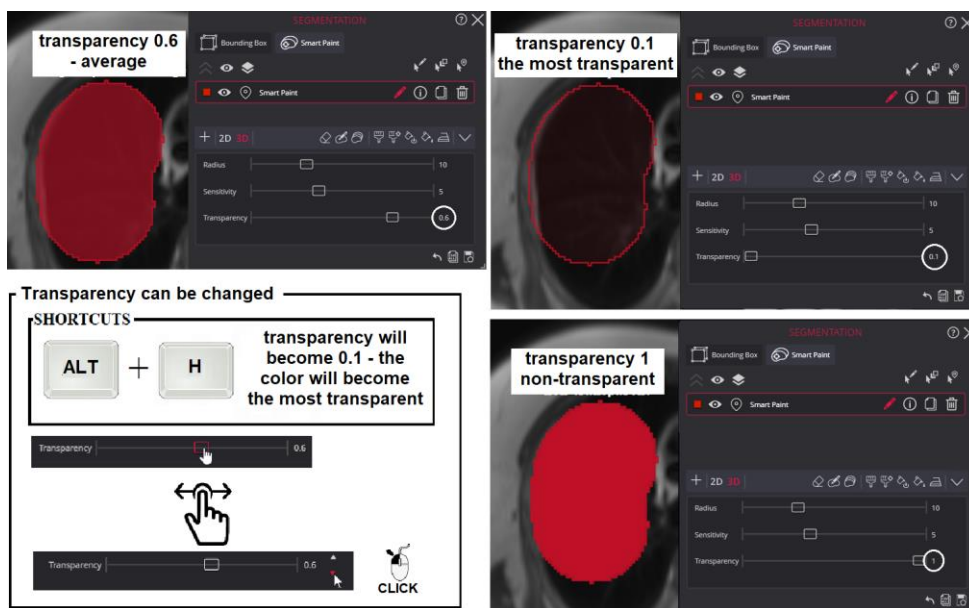

Figure 244. Transparency

Contour drawing with the smart tools

The **contour** of the segmented area is always highlighted. When a new fill color or color deletion iteration is performed, the area processed during the operation is temporarily highlighted by a separate outline. Releasing the left mouse button updates the outline of the segmented area: either the previous and new action outlines are merged or remove a colorless outline.

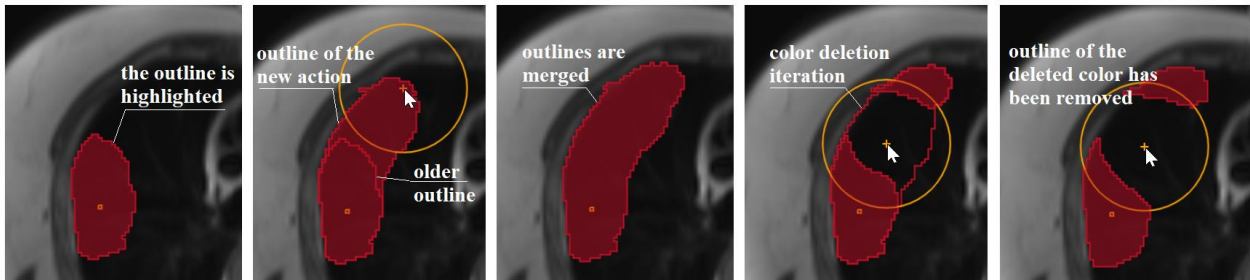







Figure 245. The outline of the segmented area

Edit Smart Paint



NOTE! The saved Smart Paint is linked to the original series where the segment is created. Editing is allowed **only in the original series**. The saved segment is linked to the original series in which it was created. The segment is visible in overlapping series and MPR reconstructions.



NOTE! Visibility in MPR reconstructions may be limited by the condition that the action window must be open. Please contact your system administrator.





To work with an existing **Smart Paint** segment, activate it by clicking:

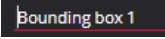



- 1) edit segment icon  on the row;
- 2) or first mark the row then press the edit segment icon  in the tools bar at the bottom of the Segmentation window;
- 3) or press on the keyboard "Alt + E" or click icon , the cursor icon changes from  to  in the viewport, hover over the segment you want to edit, the outline becomes highlighted, click the left mouse button.

The active row and edit icon are highlighted .

If a prohibition sign is displayed when the cursor is placed  or a prohibition sign is displayed when the cursor is placed , when activate "**Point-and-click**" mode, it means that the active series is not the original series, it is not the series in which the segment was created; first press  and go to the original series.

The segmentation name  and color  can be changed without editing mode.

It is possible actions before or after editing: to move the segment to the background , duplicate , delete , and undo the last action . When you have finished editing, select **Save** .

Also are possibilities to view measures , hide/show one or all segments , and hover to select  or open the image with selected segmentation .



These actions are common to Bounding Box and Smart Paint segmentation and are described in separate sections below.

Recommendations

There are no general recommendations on how to segment an organ/area as the result is highly dependent on e.g. the user experience and skills, image quality, resolution and size of the area to be segmented.

To start segmenting move the cursor to the center of the region of interest and select . Start segmenting by left-clicking and dragging in the image, similar to how a brush is used.

If there is a lot of noise in the image, it is recommended to use the .

Large areas can be segmented starting at the edges using or , or , and the inner area can be filled with the tool .

Small areas can be segmented to cover the entire area and select a tool , then the result will be obtained with a single click.

If the paint covers an area that the user did not intend to segment, the paint can be removed with Alt + any of  tools and repeat the action as painted.

When you reach the desired result in the image, move to the next image in the series.

If the shape of the organ is very irregular, you can switch to the 2D mode. This mode is also useful when you want to adjust the segmentation of only one image in a series.

At the end of segmentation, if the result has sharp corners, it can be smoothed using .

The resulting 3D Smart Paint segmentation result can be seen in three orthogonal views.

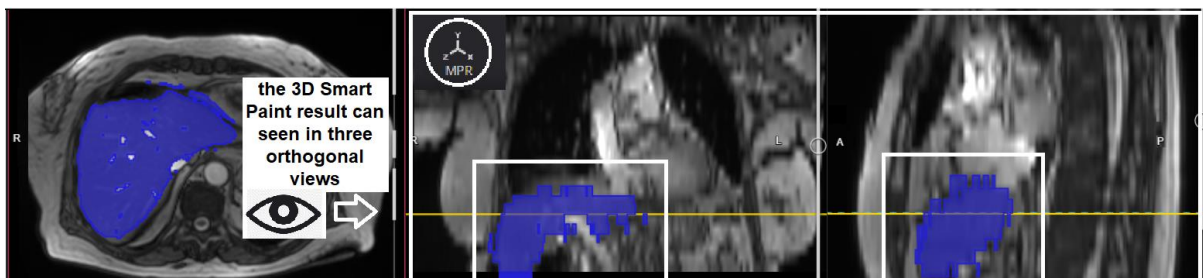

Figure 246. Smart Paint results in three orthogonal views

Common actions of segmentations

Most of the actions work the same for both Bounding Box and Smart Paint segmentations. This chapter describes the common actions.

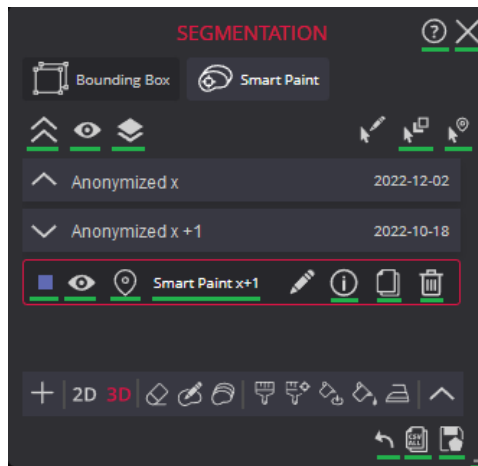



Figure 247. Common actions of segmentations

Save



To **save** the created or edited segments, press the save button  in the right bottom corner of the Segmentation window. The system converts segments data to RTSTRUCT DICOM format and sends it to PACS.

If successfully saved, the notification is displayed, and the save button changes to a color-filled star .

While storage is in progress, actions to create a new segment or modify existing segments are forbidden.



Figure 248. Actions forbidden in save progress

If the saving icon shows an empty segment, indicating that changes have not been saved.

If the user tries to close the segmentation window without saving, a warning message is displayed.



NOTE! Pressing the save button saves the segments of all tabs of the Segmentation window.



NOTE! Segments are saved in RTSTRUCT DICOM format. The function is available only if the used study storage provides DICOM saving functionality.



CAUTION! Until saved, the created, deleted or edited segments are held in program temporary storage and will be lost if closing the Viewer or closing the study, that has segmentations with unsaved changes.

Change color



To change the color of the segmentation, hover over the color box and click with the left mouse button. A color selection dialog will open:

- Select the desired color from the color bar
- Adjust the intensity from the intensity selection area above.

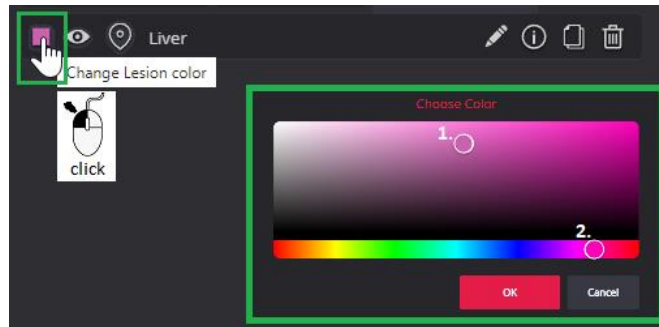
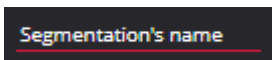

Figure 249. Modifying the color of a segmentation

Change name



To change the name of a segmentation, hover over the name and double-click with the left mouse button. The name field will be reactivated where you can enter or copy a new name.

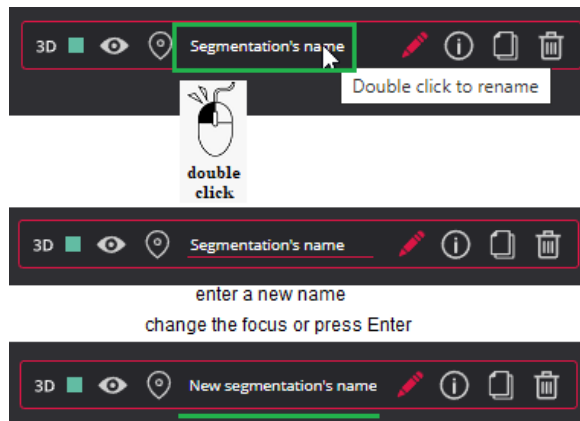



Figure 250. To change the name of a segmentation

Show/Hide



If segment viewing or editing is complicated because of contours overlap, use the segment hide function:

- press the eye icon  for the segment, which contours you want to hide;

- the system hides the contours and label of the selected segment. The grayed eye icon  indicates, that segment contours are not displayed.

If there are many segments, you can hide all tab segments (except active) by selecting the function at the top of the tab.

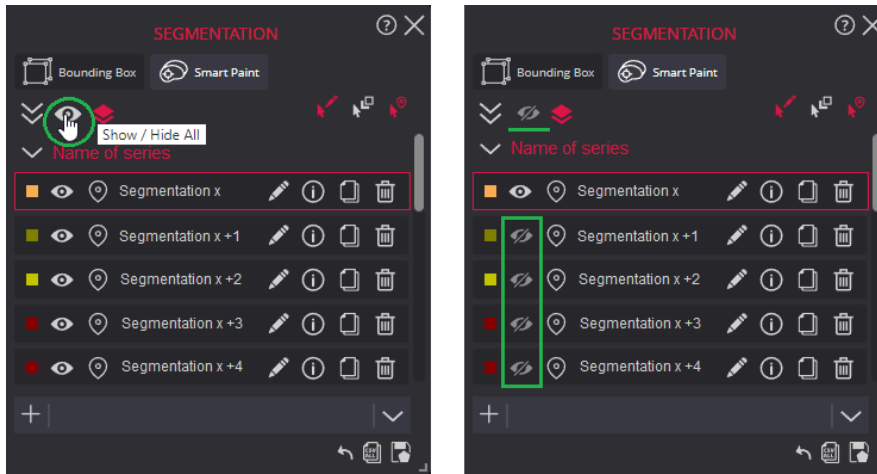



Figure 251. Show/hide all segments

Navigate



To quickly navigate to a segmentation then you can select the navigation button . When selected, the system will move to the center of mass of segmentation in series with the contour of this segment.

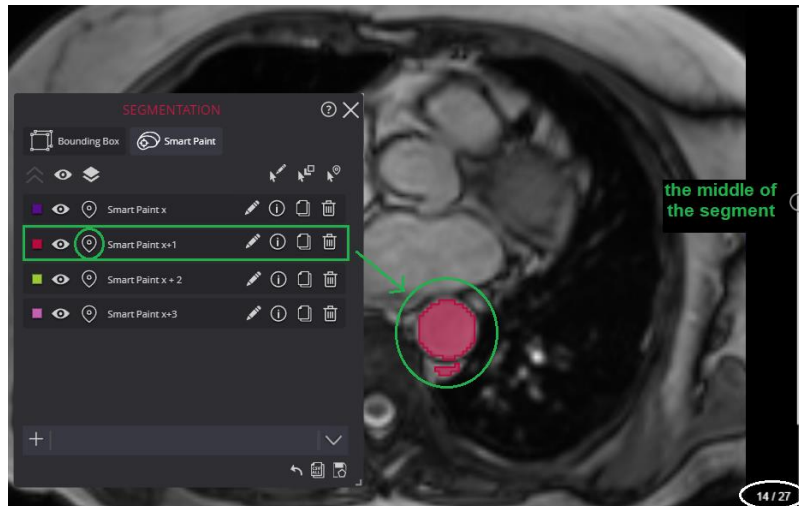

Figure 252. Navigation to the middle of the segment

If segmented in another study or in a series that is not open, the system will automatically open the required one.

NOTE! If more than one series is open in the viewport, the system navigates through all related series.
Exception, if several images of the same series are open in the viewport, then the system navigates only in one.

When a segmentation item is selected in the list, the segmentation icon is highlighted in the thumbnail bar next to the series where the segmentation was created. If the series is not visible, the system automatically scrolls the thumbnail bar until the series becomes visible.

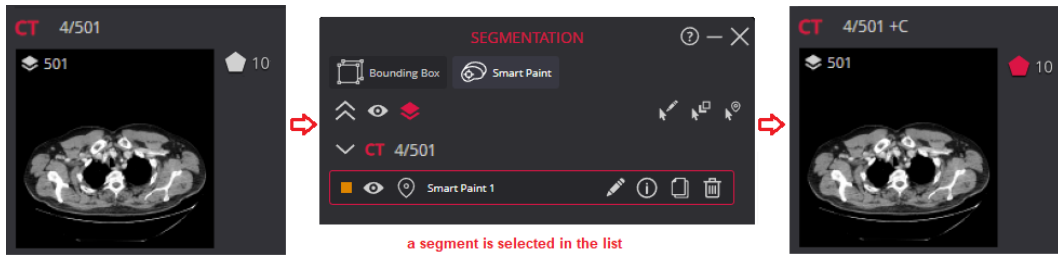



Figure 253. Highlighting a segment icon in the thumbnail bar

The segmented location/organ can be found manually:

- Open the series in the viewport and preload the series data , if not preloaded automatically. When series data is preloaded, the marks on the scrollbar  indicate the place of images with segment contours. If there are more segments, you will see more highlighted areas in the scrollbars. For example:



- Press the mark on the scrollbar to navigate to the image. The image is displayed in the viewport, and the segment contours are displayed on the image.
- Use the mouse wheel to scroll to the image one by one and see the segments on nearby images.

Measurements



The system provides the possibility to measure the area, volume, and pixel intensity statistics for a chosen segment. The measurement values are calculated per image. The volume is also measured for the whole segment. The user can view the segment measurements, or copy the measurements to the clipboard.

The volume for each segment is calculated. To view the measurements, select the information icon in the upper right corner of the window.

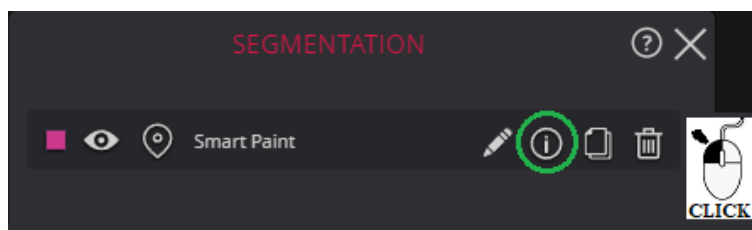



Figure 254. Measurements information

The system calculates the area, the number of volume units, for each image in the series that contains the segmented area or volume.

For example, if the segmentation is in five images in a series, the information groups will be 5, the first number “Index” indicating the sequence number of the image in the series.

To collapse the info card, press the icon  again.

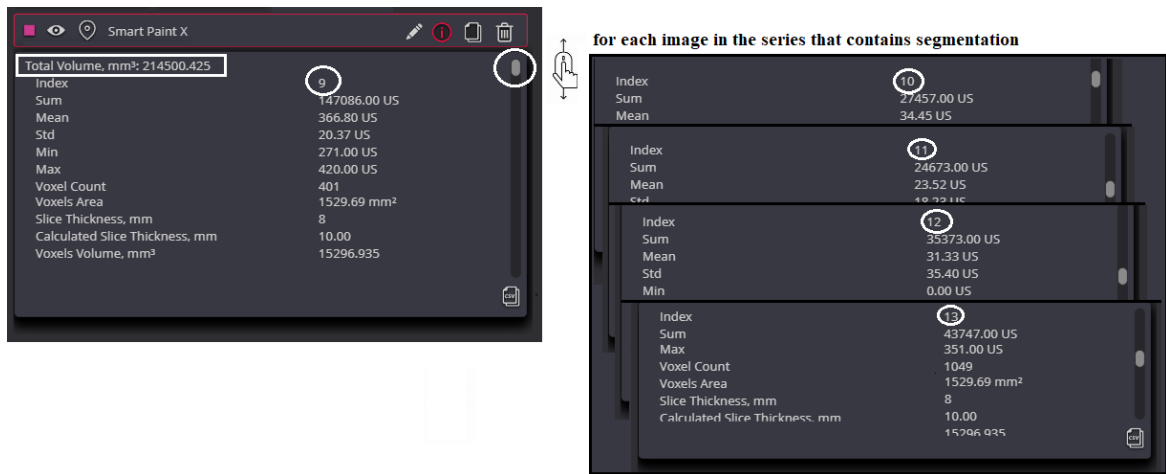



Figure 255. Measurements information for each image

To copy the measured values to the clipboard, press the Copy measurements as CSV icon , which is displayed in the bottom right corner of the Measurement window. The system copies the values, that are displayed in the Measurement window, to the clipboard.

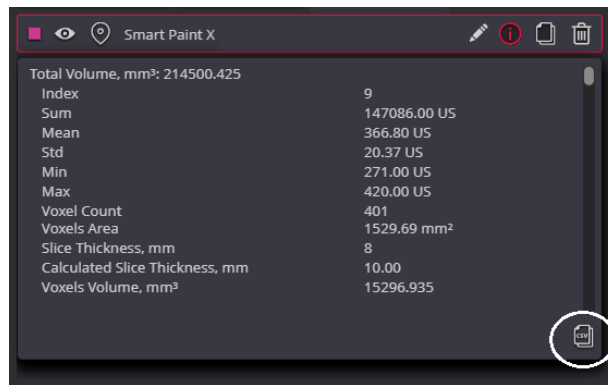



Figure 256. The information export for one segment

To copy the measured values of all segments, that are currently displayed in all tabs of the Segmentation window, press the Copy measurements as CSV icon , which is displayed in the bottom right corner of the Segmentation window. The system calculates the values for all segments and copies the values to the clipboard.

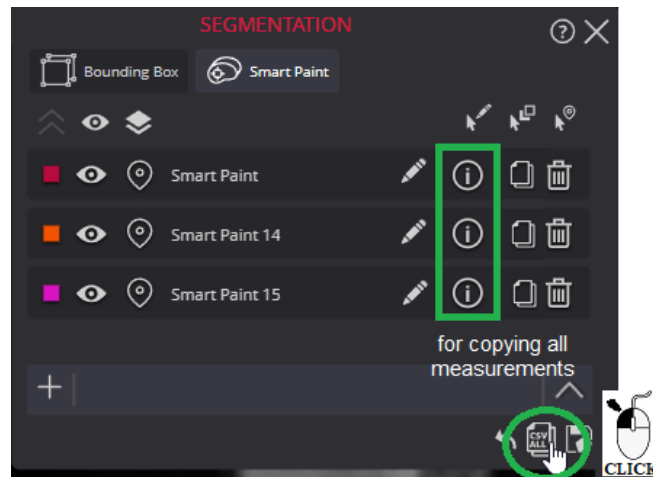

Figure 257. The information exported for all segments

NOTE! The segment is measured and values are calculated on request and are not saved in DICOM when saving segments.

WARNING! Note, that measuring functions in MedDream is approximate.

The following values are measured and displayed per image, that contains the region of the segment:

- The Slice thickness value from the DICOM file is displayed for the image, if available.
- The Calculated slice thickness is measured based on the position and orientation of the image itself and neighboring images. The value is calculated for parallel slices, and only if the image position and orientation in patient coordinate system data are available in DICOM.

NOTE! The Slice thickness value and Calculated slice thickness measurement are applicable for CT, MR, and PET modalities, and not applicable for MG and DX modality.

NOTE! The Slice thickness value and Calculated slice thickness measurement are applicable for **Free Draw** segments, and not applicable for **Bounding Box** segments.

- Voxel count is the number of voxels that are counted as belonging to a segment on this image. A voxel belongs to the segment if the center of the voxel (pixel in the 2D image) is in the contour or inside the segmented region.
- Intensity values for the voxels that belong to a segment on the image: minimum intensity, maximum intensity, mean intensity, standard deviation, and sum.

NOTE! The radiodensity in Hounsfield units (HU) is calculated for images of CT modality. The Body Weight standard uptake value (SUVBW) in g/ml is calculated for images of PT modality. For other modalities, or in case the data required for HU or SUVBW calculation is not available in the DICOM file, the pixel intensity values are used.

- Voxels area is calculated by multiplying the row spacing, the column spacing, and the voxel count. The value is calculated only if the pixel spacing information is available in the DICOM file.

NOTE! Voxels' area may not be equal to the geometric area inside the contours of the segment.

- Voxel volume is calculated by multiplying the voxels area and calculated slice thickness if these were measured.



NOTE! The Voxel volume measurement is applicable for **Free Draw** segments, and not applicable for **Bounding Box** segments.

The total volume measurement per the whole segment is also available:

- The total volume for the **Free Draw** segment is calculated as the sum of the volume of the voxel per each image that contains the regions of this segment.
- The total volume of the 3D **Bounding Box** segment is calculated as the geometric volume of a 3D cube, by calculating the length of the three cube edges (length, width, and height) from the coordinates of the corner points in the patient coordinates system, and then multiplying these lengths.



NOTE! The total volume measurement is not applicable for the 2D **Bounding Box** segment.



NOTE! The volume is not measured, if the data, that is required for calculations, is not available in the DICOM files.

- The Total volume, if applicable, is displayed on the top of the window. The measured values per each image, that contains the regions of this segment, are displayed below.



NOTE! The 3D **Bounding Box** measurement values are always calculated for the referred series.

Duplicate



To create a new segmentation as a copy of the existing:

- Open the Segmentation dialog and select the segment from the list that you want to duplicate.
- Press the Duplicate icon , which is displayed on the right side of the row.
- The system creates a copy of the selected segment, assigns a label and a color to it, and displays the contours on the image. The new segment is added to the tab of the Segmentation window.



NOTE! The newly created copy is displayed on the original segment, so the old contours are not visually visible. The system activates the newly created copy for editing.

The Bounding Box segment can be change the position: move the mouse cursor to the middle of the segment until a blue circle appears. Click the left mouse button and without releasing bring a copy to the right place.

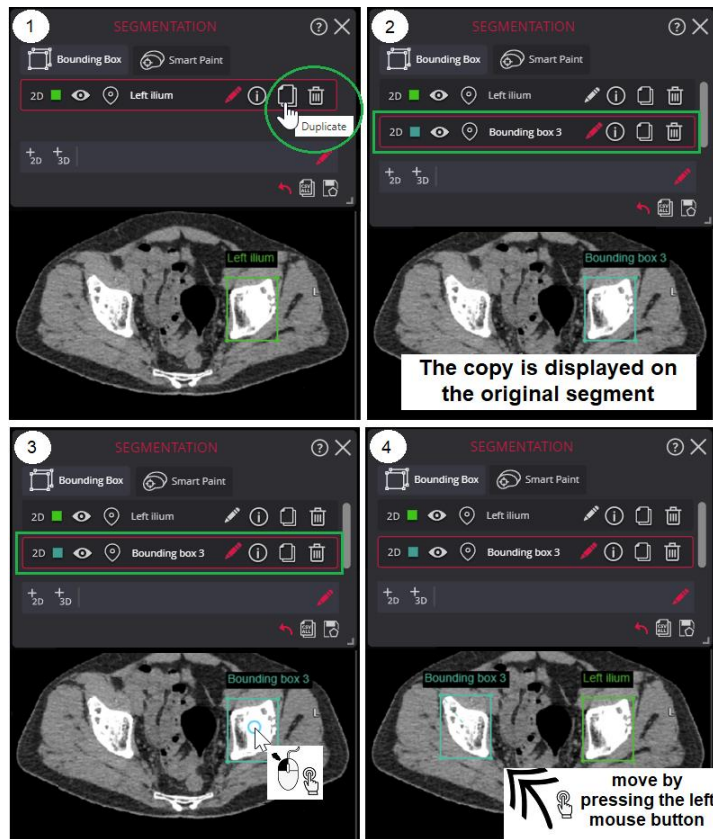

Figure 258. Left ilium segmentation duplicated and created Bounding Box 3 copy moved

Note. The Smart Paint segment can not be moved but can be hidden. After the original segment is changed, this duplicate can be used to evaluate the change.

Delete



To delete the segment: press the Delete icon , which is displayed on the right side of the row.

the system will ask you to confirm the delete action and will remove the segment contours from all images and the row from the list.

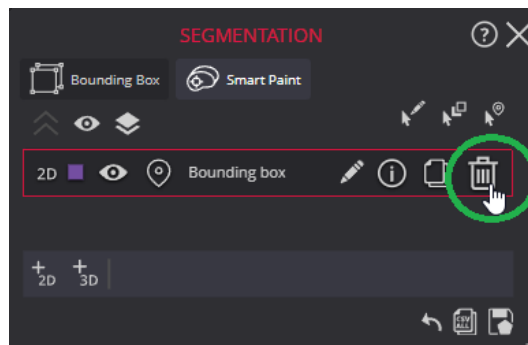









Figure 259. Delete the segment

 **Note.** The delete action cannot be undone.

Grouping

The information in the actions window will be automatically grouped by study if more than one study is open and there is more than one segment. The header displays the patient's name and the date of the study.

The user can indicate that he/she wants additional grouping by series . When selected, the icon changes to red  and the list records are additionally grouped by series in which they were created, with the series information in the group header.

To view group content, press . To collapse press . To expand all groups, press . To collapse all groups, press .

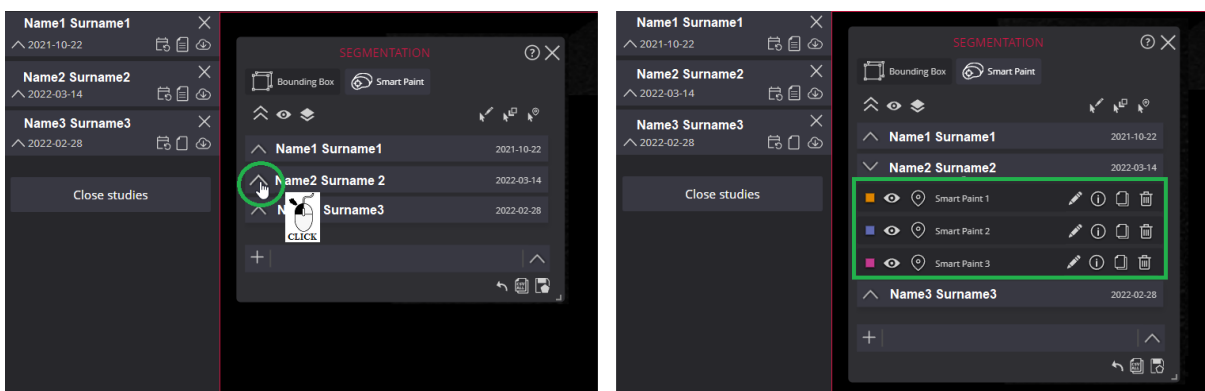

Figure 260. The groups by study

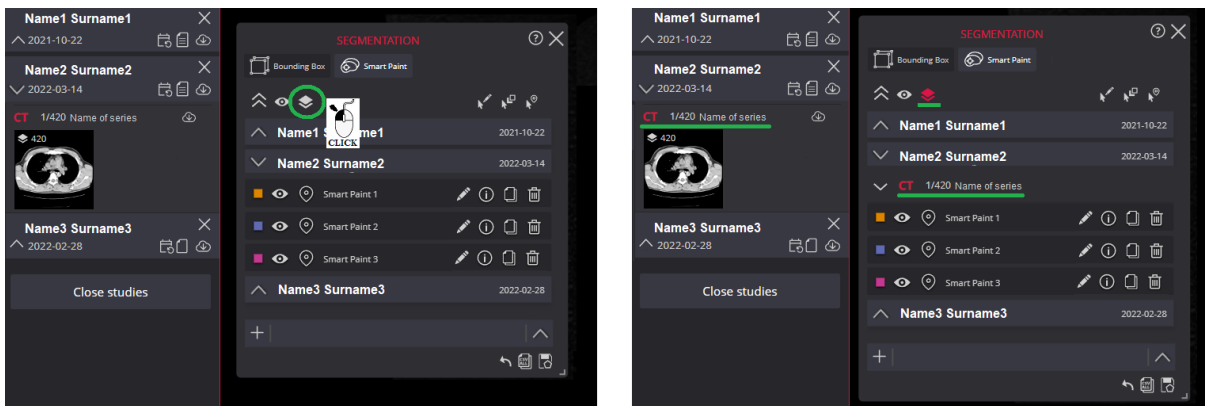





Figure 261. The groups by series

Send to background





If the segment you want to edit is covered by another segment, the interfering segment can be moved to the background:



- press on the keyboard "Alt + B" or click icon 

- the cursor icon changes from  to ;
- in the viewport, hover over the segment you want to move to the background;
- the outline becomes highlighted;
- click the left mouse button, the system moves the interfering segment to the background.

Hover to select



The option to enable a mode **Hover to select**  that changes the mouse cursor from  to , and when hovering over a segment in the viewport, to see the system open the appropriate segmentation tab **Bounding Box** or **Smart Paint** and mark the item in the list on which the cursor was hovering.

This mode can work in combination with **Click to Edit**  or Click to Send to Background  modes. In this case, the system not only marks the item in the list, but also performs the corresponding action.

Can also operate without additional modes .

Undo the last action

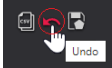

The Undo button  is available to all tabs of the Segmentation window.

The system provides the ability to undo one last action. Select .

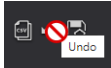
After undoing the last action or saving changes the button then becomes inactive .

Shortcuts, Close Window

Users can view segmentation action shortcuts, close the action window by performing actions on any segmentation tab, minimize and resize the window.

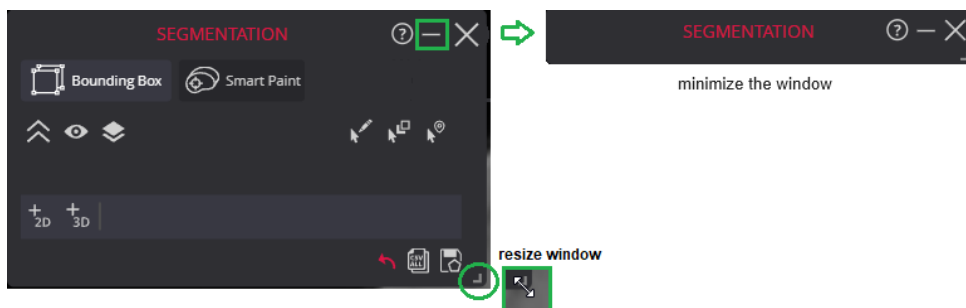



Figure 262. Minimize and resize Window

To recall the segmentation shortcut combinations, you can find them by selecting the help icon  in the upper right corner of the window.

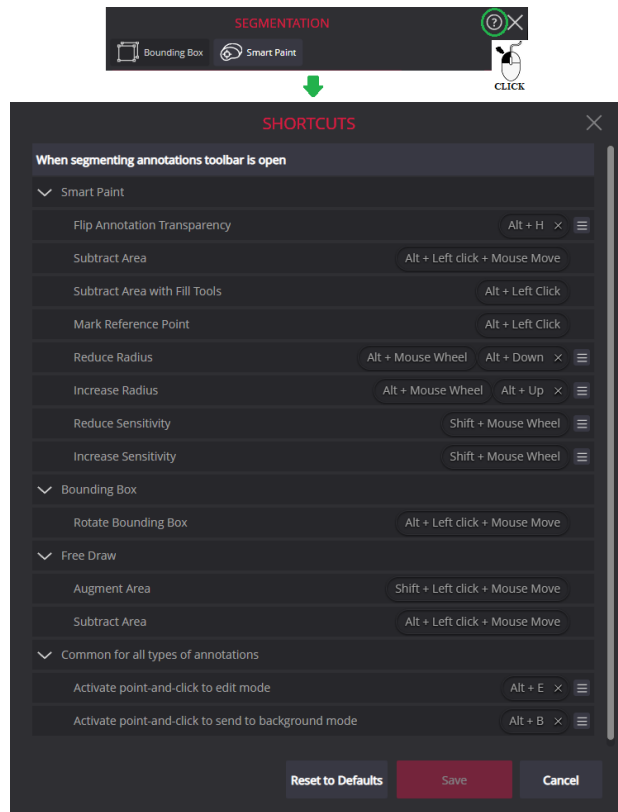



Figure 263. Shortcuts

If you have finished the segmentation actions or do not want to continue it, close the window by pressing .

If the last segmentation actions performed were not saved, the system will display a message.

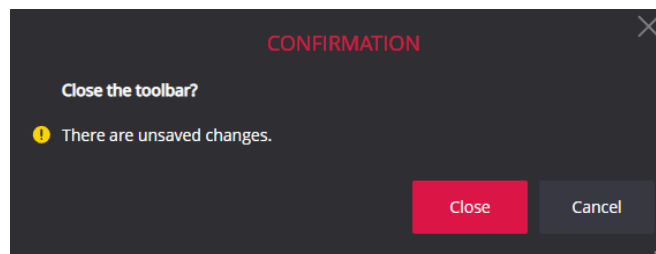





Figure 264. Message attempting to close a window without saving

To keep the action taken, select . Then the message will close and you will return to the action window where you have to make your selection .

Then selecting  the window will close without saving changes.

If the changes have been saved, the save button will be displayed with a color-filled star  and the message will not be displayed.

About moving or resizing the window see in the common section.

Tools for study exchange

Share files via DICOM Library

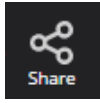

Share via DICOM Library tool is used to send files to DICOM Library.

Select the images you want to share:

- To send several images from different series or studies:
 - select the layout to fit the images you want to send,
 - and open the required images in separate viewports;
- To send one image, or series of images, or the whole study
 - open the required image, or any image of the required series/study in the viewport,
 - or activate the viewport with such an image.

Press **Share via DICOM Library** button, and dialog window will appear on the screen. Please indicate, what are you going to send in expandable list of available **Scope** selection:

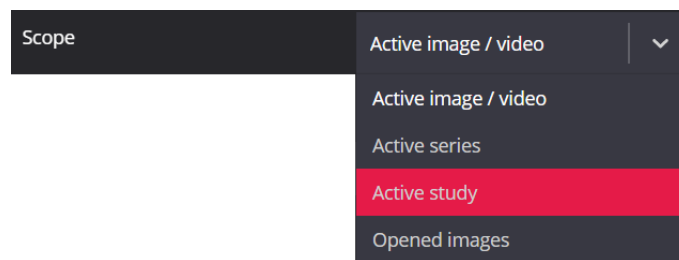

Figure 265. Selecting scope for sharing via DICOM Library

Please enter e-mail of the sender and recipient, subject, and message for recipient. If needed, change the e-mail template language in the expandable languages list above the message entry field. When done with data entry, click **Send** button.



NOTE! The sender's email address and subject field may have default values, if entered in system configuration.



NOTE! You can resize the message entry field to fit the message by dragging the bottom right corner of the field.



CAUTION! The system does not anonymize the content of shared images and entered message. You take responsibility for sensitive data in shared information.

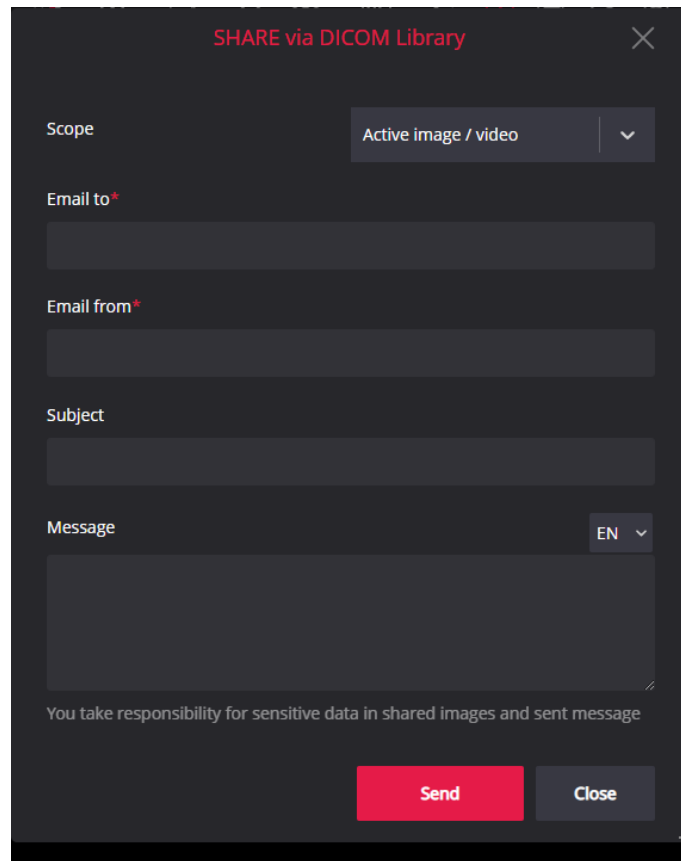

Figure 266. Share via DICOM Library dialog window



NOTE! Share files via DICOM Library function should be enabled and the required parameters should be set in configuration.

Forward



The tool **Forward** is used to send the studies, that are currently opened in viewer, to the remote device.

Clicking the **Forward** button opens the forward window with the list of forwarded studies in it:

- The study with currently viewed image is marked in list of forwarded studies, if the active viewport contains image;
- All the studies are marked in list of forwarded studies, if the active viewport is empty.

You can change the studies marking in forwarded studies list in forward window. See detail forward window description in section “Export and Forward”.



NOTE! **Forward** function should be enabled and the required parameters (list of forward destination machines) should be set in configuration.

Export



The **Export** tool lets you save an active image, series, or entire study as an archive or as an ISO image for recording on CD / DVD media.



NOTE! **Export** function should be enabled and the required parameters (path to DICOMDIR viewer and size of ISO archive) should be set in configuration.

Please, select the studies for export:

- To export one currently viewed image, series, or study, activate the viewport with series/studies image and click Export tool's button;
- To export all the studies, that are currently opened in viewer, activate the empty viewport and click Export tool's button.

Clicking the **Export** button opens the export window with the list of studies selected for export in it. You can start a new export in the export window, or to open the previous export jobs list. You can use the Export menu for opening the export jobs list directly:

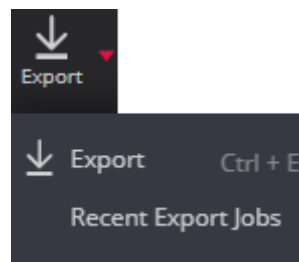

Figure 267. Recent Export Jobs option in Export menu

See detail export window and recent export jobs window description in section “Export and Forward”.

LiveShare



LiveShare tool is used to share the content of user's (further named as host) Viewer window with one or more other users (further named as guests).

First, prepare the Viewer window for content live sharing:

- Open the studies you are going to share in the Viewer window, and close the studies, that are not supposed to be shared.



CAUTION! The system grants to the guests the access to all the studies, that are opened in host's Viewer window when starting live sharing, and these studies will be displayed in the thumbnail panel of the guests' Viewer window. Opening or closing the studies, while sharing is on, is not supported.

- Select preferred layout and open images in viewports.

NOTE! Live sharing is dedicated for images. Multiframe, video, ECG, PDF, SR documents is not supposed to be live shared.

To start live sharing, do the following:

- Press the **LiveShare** button to open the LiveShare host window:

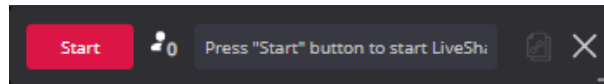



Figure 268. LiveShare host window when live sharing not started

NOTE! You can change the shared studies list, while liveShare session is not started and guest URL is not generated by system.

- Press the **Start** button in the LiveShare host window to start live sharing session. The system warns about limited live share functionality, and you should confirm the action. The system generates the guest URL and shows it in the LiveShare host window.
- Deliver the guest URL to session attendees:
 - Copy the guest URL to the clipboard by clicking Copy LiveShare link button , or using keyboard shortcuts in URL field: CTRL+A for selecting the link text, and CTRL+C for copying the selected text to clipboard;
 - Paste the copied link and send it to session attendees.
- When remote attendee launches the guest URL, the guest Viewer window with the live shared studies is opened and connected to your liveShare session, and the Viewers count is updated in the LiveShare host window:

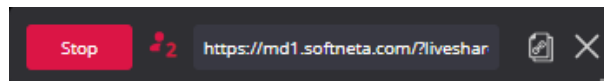

Figure 269. LiveShare host window with liveShare session running and two guests connected

NOTE! The non-modal LiveShare host window should not be closed, while liveShare session is running. Closing the window ends the liveShare session.

The guest URL may be copied, send to guest user, and guest may connect at any time during the session. The number of guests is not limited.

NOTE! Separate license connection is used per host, and per each connected guest.

Do the work you want to share with session attendees, after guests are connected. The live sharing of the following actions is supported:

- Changing the appearance of the Viewer window (layout, thumbnail panel position, multi-image);
- Opening images in viewports;

NOTE! Live sharing is dedicated for images. Multiframe, video, ECG, PDF, SR documents is not supposed to be live shared.

- Changing windowing values;
- Image spatial transformations (pan, scale, rotate, flip);
- Image scrolling (scroll menu actions, scrollbar actions);
- Location functions (reference line, crosshair);
- Measurements (except the calibration line);
- Resetting changes in viewport (applied measurements, spatial transformations);
- Multiplanar reconstruction (orthogonal planes).

The guest Viewer window repeats the host Viewer window content and host's actions:

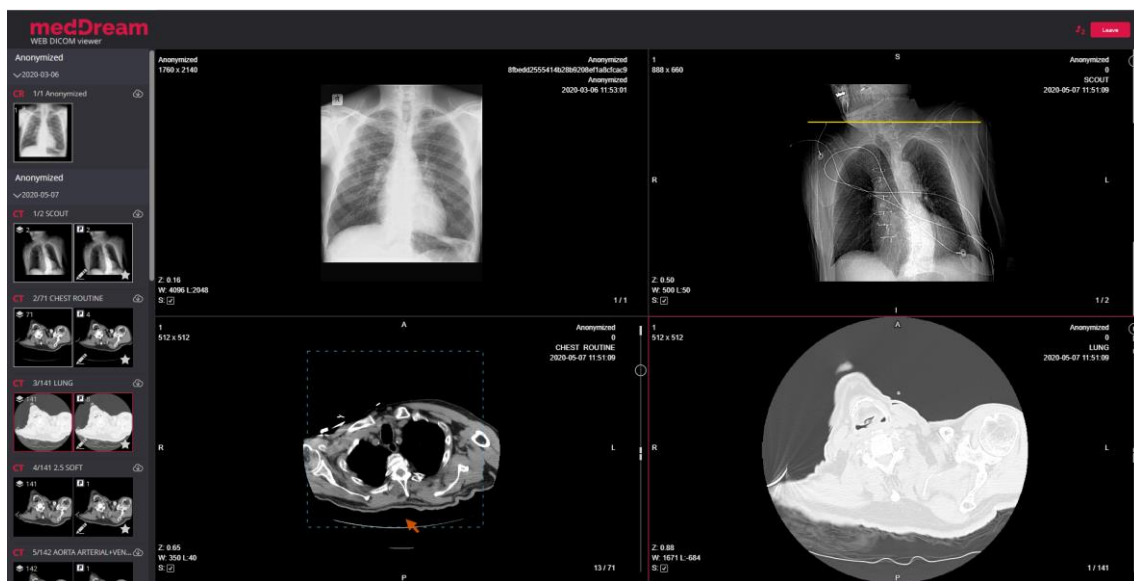



Figure 270. Guest Viewer window

LiveShare session guest is not allowed to perform any action with studies and images in the guest Viewer window.

Guest may leave the liveShare session by pressing the Leave session button in Guest Viewer window. If guest has left the session, the Viewers count is automatically updated in the LiveShare host window.

Stop the liveShare session, when done:

- Press the Stop button in the LiveShare host window, or
- Close the LiveShare host window with Close button , and the liveShare session will be stopped.



NOTE! LiveShare function should be enabled in configuration, and sockets connection to MedDream server from host's and guests' workplace should be allowed.

Fusion function

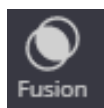

The **Fusion** function allows you to combine the series: overlay the selected for fusion series on the already displayed series. For example, link the PET series representing the sites of radioactive drug concentrations with the anatomical patient structure. The series fusion function can be selected only after loading the series into the active window. The **Fusion** function is achieved by selecting the Fusion icon in the main toolbar.

NOTE! The **Fusion** function by default provided of CT, MR, and PET modalities. The list of modalities and/or SOP classes can be extended or reduced. For more information, see the install manual.

To start fusion:

- Select or open the image the CT, MR or PET series that you want to combine with other series.
- Click **Fusion** button and open the Fusion window:

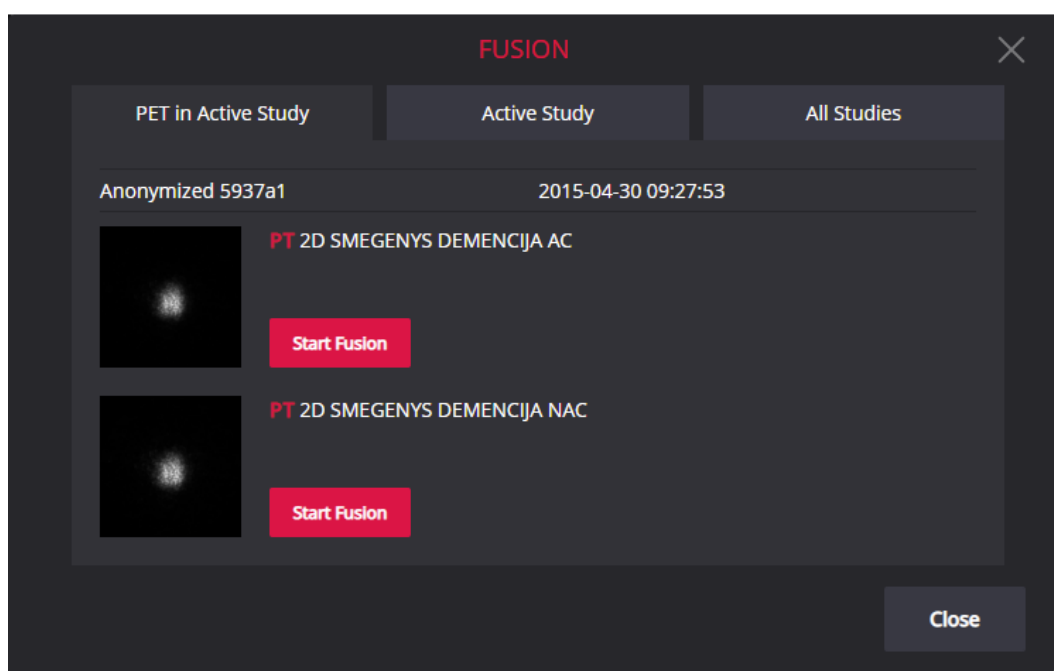

Figure 271. Fusion window

- In the Fusion window the user can select the series from the active study or from the other studies, that are opened in the Viewer. Select the series you want to overlay with the already viewed active series, and click the **Start Fusion** button.

NOTE! If the active study has PET series, they are displayed in the separate tab, and this tab is selected by default on Fusion window opening.

NOTE! CT, MR, or PET series from any study, that is opened in the Viewer window, may be selected in All studies tab. This allows the user to combine series of different studies.

- The program preloads viewed active series, and the selected series, if not loaded earlier, and then fuses them. The preload process progress is seen on the screen.

NOTE! The time of series preload process depends on the size of series and the connection speed.

- Once the fusion process is finished, the fusion series and the toolbar of fusion series are displayed in the active viewport:

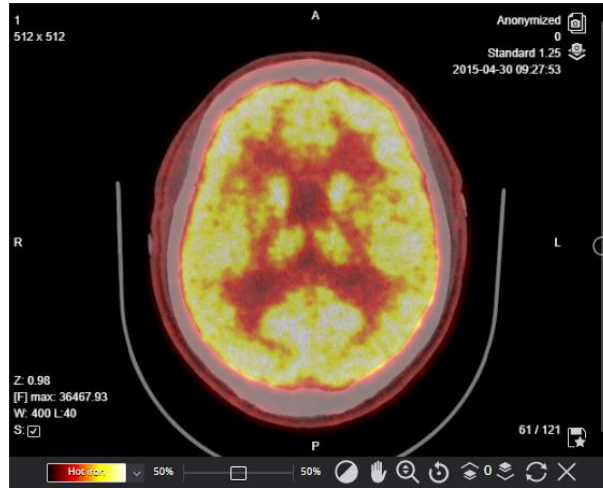

Figure 272. Fusion series

Manipulating fusion series

The functionality of the fusion series toolbar is described below.

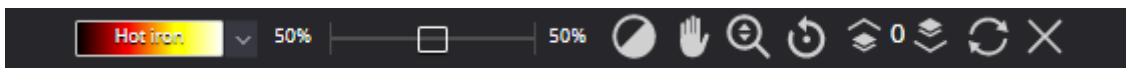

Figure 273. The toolbar of the fusion series

1. Changing the color range

By default, the **Hot iron** color range is applied to the PET or other top image of fusion series. However, according to the specificities of the anatomical body sections analyzed, different color range can be used. The choice of the color selection is performed by expanding the list of color schemes and choosing the desired color range. **None** option displays overlaid image pixels in greyscale. The selected color range is automatically applied for the fusion top series immediately after selection.

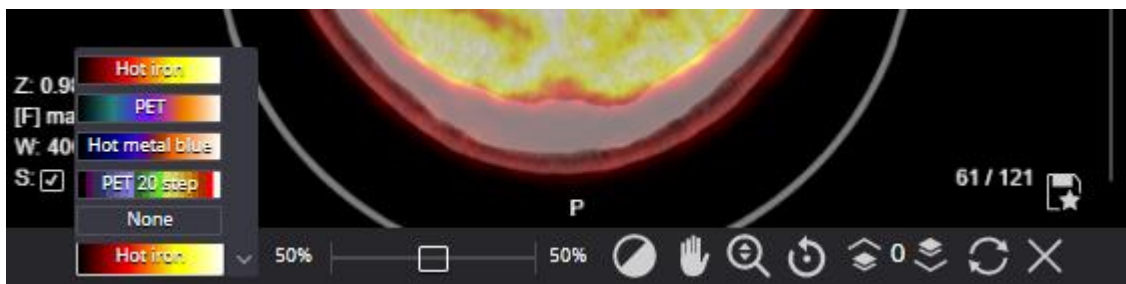

Figure 274. Changing color range of the fusion top series

2. Changing the fusion ratio

In the analysis of fusion series, it is important to have the ability to change the fusion ratio, what affect better visibility of bottom or top series. You can change the ratio in fusion ration bar by dragging the marker to the right

or the left, exposing the top or the bottom series. In this way, one or the other series is highlighted and a clearer view is provided. By default, the 50% to 50% ration is applied.



Figure 275. Fusion ratio bar in fusion series toolbar

3. Upper layer data adjustment

If the fusion of the series is not completely symmetrical, then the **Pan** tool in the fusion series toolbar can be used. This tool allows you to change position of the top fusion series and visually anatomically link the fusion series.

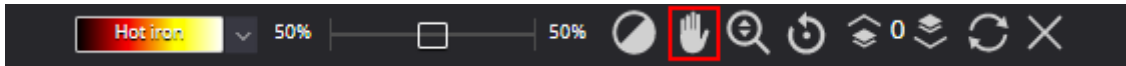

Figure 276. Pan tool in fusion series toolbar

NOTE! To change the position of the whole fusion images, use the **Pan** tool located on the main Viewer's toolbar.

4. Adjust the contrast and brightness of the upper layer

By choosing the **Windowing** tool in the fusion toolbar, the user can change the contrast and brightness of the top fusion series. If the **Windowing** tool is selected from the Viewer's main toolbar, then the brightness level of the bottom series is changed. Note, that brightness of top or bottom series may be changed from the other viewport, if synchronize windowing for the same series is switched on.

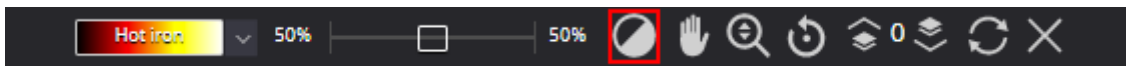

Figure 277. Pan tool in fusion series toolbar

5. Upper layer zoom function

By choosing the **Zoom** tool in the fusion toolbar, the user can change the scale of the top fusion series. If the Zoom tool is selected from the Viewer's main toolbar, in this case the overall (top and bottom series) scaling is changed.

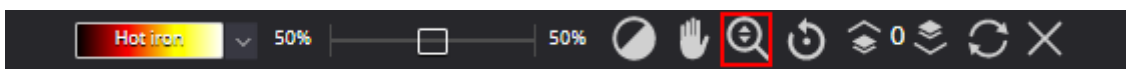

Figure 278. Zoom tool in fusion series toolbar

6. Upper layer rotation

By choosing the **Rotate** tool in the fusion toolbar, the user can rotate the image of the top fusion series. If the **Rotate** tool is selected from the Viewer's main toolbar, in this case the whole fusion image (top and bottom series) is rotated.

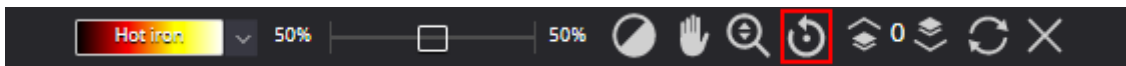

Figure 279. Rotate tool in fusion series toolbar

7. Upper layer image overlay

If there is a mismatch between the fusion series, the series images can be shifted with the **Manual Adjustment** tool in the fusion series toolbar. Clicking the down-pointing chevron button shifts the image of the top fusion series to the next, and clicking the up-pointing chevron button shifts the image of the top fusion series to previous one.

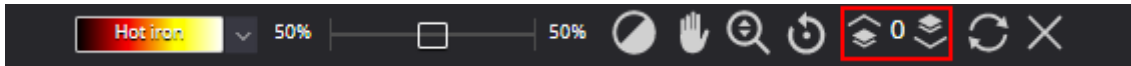

Figure 280. Upper layer Manual Adjustment tool in fusion series toolbar

8. Standard Uptake Value (SUV)

The main measurement used in the fusion series is the standard uptake value (**SUV**). The standard uptake value is calculated according to the formula:

$$SUV_{bw} = \frac{\text{weight in grams}}{\text{injected dose}}$$

The **Standard Uptake Value** is calculated by choosing **Ellipse** measurement (see description in section “Ellipse”) from the **Measure** expandable menu in the Viewer’s main toolbar and marking the location in the fused image. Three standard uptake values (average, minimum and maximum) are calculated:

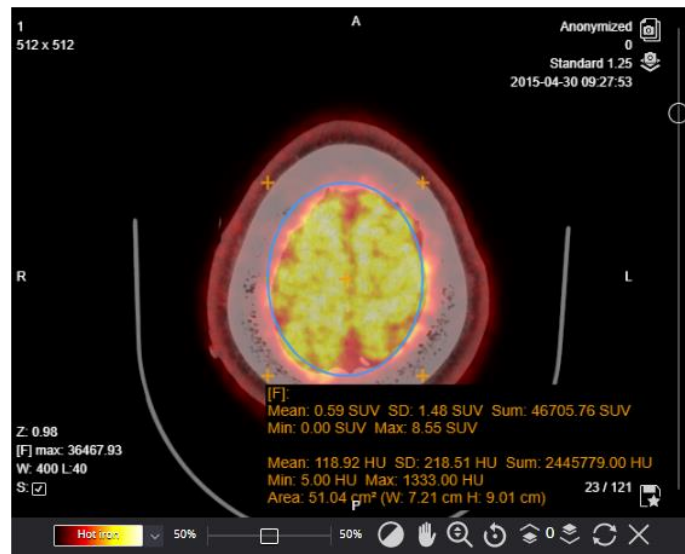

Figure 281. Standard uptake value measurement in fusion series

9. Reset top series manipulations

Reset button in fusion series toolbar cancels all the manual adjustments that were done with the top fusion series and restores the fused series to the original state.

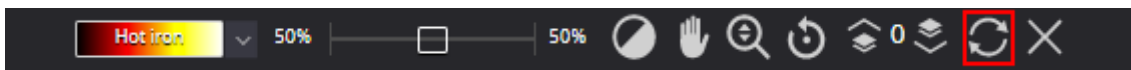

Figure 282. Reset button in fusion series toolbar

10. Closing fusion series

To close the fusion series, click on **Close** button (**X** icon) at the end of the fusion series toolbar.

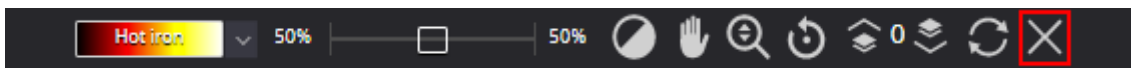

Figure 283. Close button in fusion series toolbar

Cine mode



Using **Cine mode**, you may put all series images into one movie. Click on the **Cine mode** tool in Viewer's main toolbar wait until the series images preload is done, if not loaded earlier:

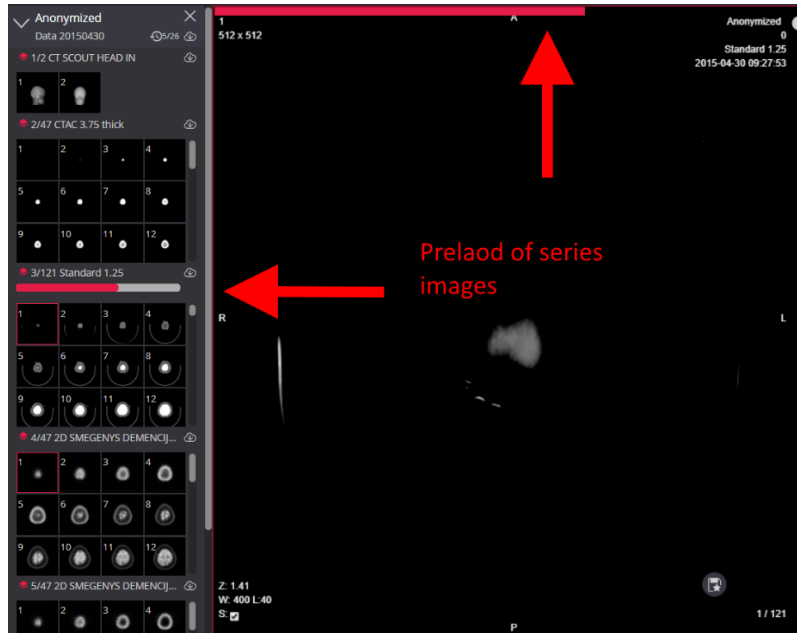

Figure 284. Preload of series data for cine mode



When images are preloaded, the function allows you to play series images as movie (one image corresponds to one frame):



Figure 285. Cine mode movie playing

Toolbar for controlling the movie playing is displayed at the bottom of the viewport:

- To switch the movie playing off or on, click Pause or Play button. The button icon changes correspondingly to the current play status;
- To increase or decrease the movie frame rate, click '+' or '-' button correspondingly. The changed number of frames per second is displayed in toolbar , and immediately applied;

- To view the movie frame by frame, use the Previous Instance  and Next Instance  buttons. If movie was playing, clicking the Previous Instance or Next instance button pause movie and then navigates to the previous or next frame from the stopped frame until movie beginning or end is reached.

To turn the Cine mode off, just open an image from a different series in the same viewport, or click the **Cine** button once more time.

 **NOTE!** **Windowing**, **Pan** and **Zoom** functions are available during cine mode (see [Manipulating and analyzing images](#)).

Other Viewer tools

Series



Series button opens the **Study** window:

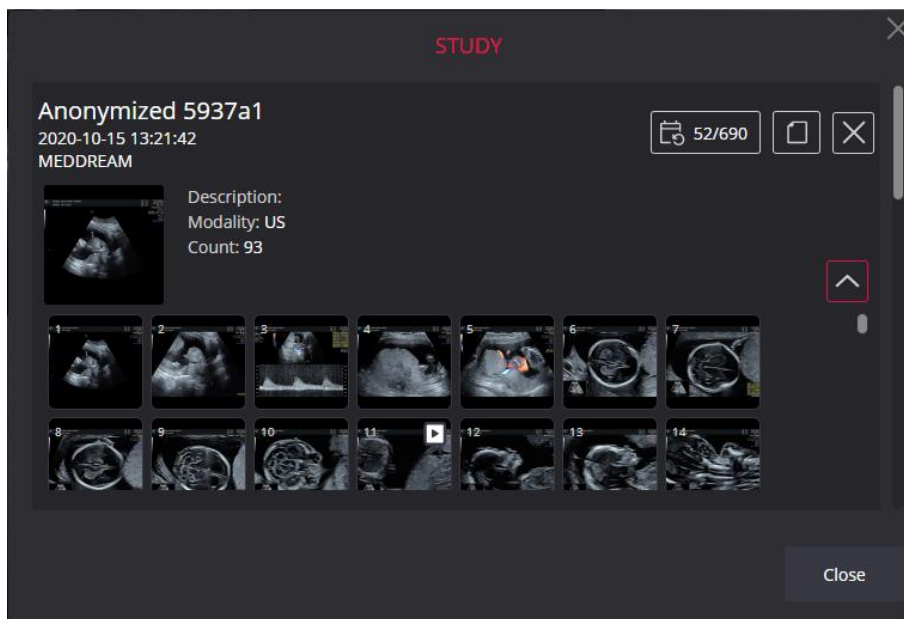





Figure 286. Study window

At the top of the window the patient name and study date are displayed. The study information is followed by the list of study's series. The series description displays the following: the thumbnail of the first image, series description, modality and number of images in series.

In Study window you can perform the following:

- Expand or collapse the series images list by clicking the chevron icon at the right of the series description;

 **NOTE!** The chevron icon is not displayed if not showing the image thumbnails is configured for the series.

- Open the image in viewer window by clicking the image thumbnail in series description or expanded series image list;
- Open patient's studies modal by clicking the patient's history icon  on the right side of the study description. See detail description in section "Patient history";
- Open the study report form (see "Report module" section for detail description) by clicking the Create report  icon, or Edit report  icon at the right of the study description;
- Delete the study from the viewer's window and study window by clicking the **Close** button (icon **X**) at the right of the study description.

Plugins



Plugins button extendable menu holds links to external systems and services. The plugins are displayed in expandable menu of **Plugins** button, if configured by system administrator. You can run the external plugin by clicking the appropriate menu action.



NOTE! The system may automatically run external plugin, if automatic start is configured.



NOTE! Third party plugin for DICOM print may be integrated for some PACS. For details, contact to Softneta support at this email: support@softneta.com.

Full Screen



Full Screen button is used to turn on the full screen mode. Move mouse cursor on **Full Screen** icon and click it - the Full Screen mode will be enabled. Click either the icon once again or ESC button in the keyboard in order to exit the Full Screen Mode.

Theme



Theme changes MedDream default color (red color in standard product version) to the blue color that is clearly visible on black and white monitors.



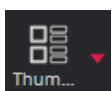

NOTE! The default color may be different if the product is used in an integrated solution and rebranded to meet the colors of the integrating system.

Thumbnails



Thumbnails button enables changing the thumbnail place in viewer window. You can select the desired place from dropdown menu: Left; Top; Bottom; Right; Quick menu.

 **NOTE!** The user selection is saved in browser's local storage and used when starting the viewer. If local storage does not contain the thumbnail position value, the position is set according the system settings.

 **NOTE!** The default thumbnail place is configured in [Settings](#).

Preload Series



The **Preload Series** button preloads the series images, so scrolling the images with mouse wheel works much faster. Once you click the preload icon, preloading starts and preload progress bar appears in the viewport:

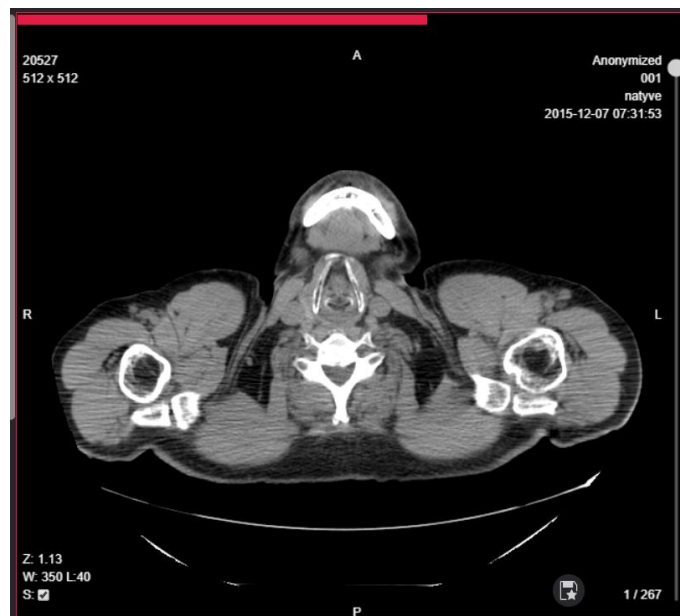

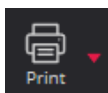

Figure 287. Series preload process progress bar

 **NOTE!** The **Preload series** button is not displayed if the series data is already loaded.

Print



To print images, click **Print** button (enabled for images, videos, and multi-frame, and disabled for ECG, SR and pdf documents). There are two print options:

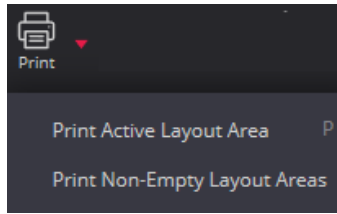

Figure 288. Print options

Click on one of Print options (**Print Active Layout Area** or **Print Non-Empty Layout Areas**) in order to print the view of selected viewport.

Hanging protocols

NOTE! Hanging protocol is automatically applied only to the first study that is opened in the viewer.

NOTE! Other hanging protocol may be manually selected only from applicable Hanging protocols groups and protocols.



Clicking the **Hanging protocol** button opens Hanging protocol options window.

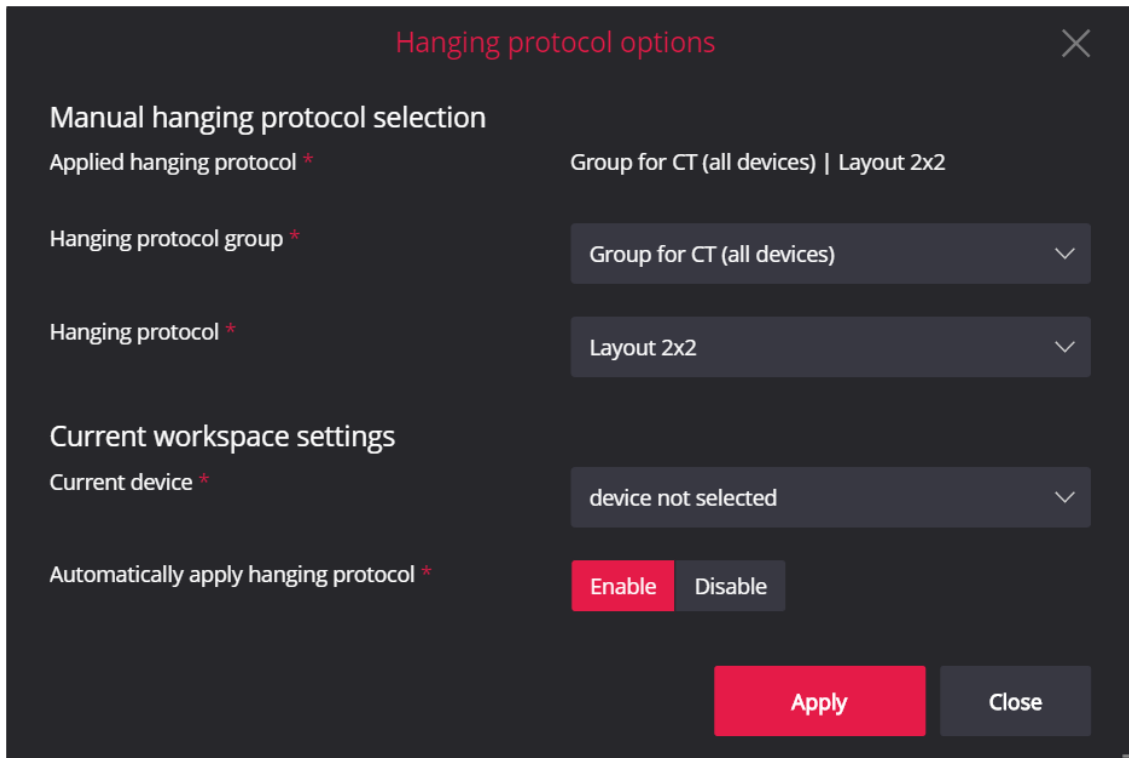

Figure 289. Hanging protocol options window

You can see the currently applied hanging protocol and apply the other hanging protocol in **Manual hanging protocol selection** section.

To apply other hanging protocol:

- select the hanging protocol group from **Hanging protocol group** drop-down list;
- select the hanging protocol from **Hanging protocol** drop-down list;
- click **Apply** button.

In **Current workspace settings** section, you can see and change the setting of automatic apply in workspace:

- to change device setting select the device from **Current device** drop-down list;
- to change the **Automatically apply hanging protocol** setting select **Enable** or **Disable** button;
- click **Apply** button to save the settings.



NOTE! The workspace settings are saved in browser's storage and are applicable only for the same browser.

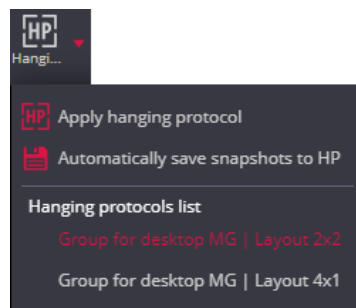



Figure 290. Hanging protocol menu options

Hanging protocol button's pop-up menu provides quicker access to some information and functions of Hanging protocol options window:

- menu **Apply hanging protocol** shows the current property value – highlighted icon  means that that hanging protocols execution and apply is enabled. Clicking the menu inverts the value and highlighting;
- menu **Automatically save snapshots to HP** shows the current property value – highlighted icon  means that that hanging protocol snapshot is automatically saved and loaded on the quick navigation actions, that are described below. The snapshot icon in the protocols list indicates the saved or displayed snapshot, as described below.

The snapshot saves the displayed images, annotations, visual and spatial transformations, that the user has applied to the images. In general, one snapshot is saved for a hanging protocol. In case the hanging protocol has multiple multi series pages or comparison studies to show, the separate snapshot is saved per each multi series page and/or comparison study. If previously saved snapshot exists for the protocol, it is automatically displayed.



NOTE! The snapshot saving is available only in Hanging protocols version v2.

- menu group **Hanging protocols list** lists all the applicable protocols. Currently applied protocol is highlighted.

The icon  near the hanging protocol name in Hanging protocols list indicates, that at least one snapshot is saved for this hanging protocol. The icon  near the highlighted hanging protocol name in Hanging protocols list indicates, that the previously saved snapshot is displayed.

Clicking the hanging protocol menu clears all the snapshots, if saved previously, and opens the initial hanging protocol. Use the quick navigation actions, that are described below, to keep and display the saved snapshots.

The other way to quickly navigate through the protocols of the applied hanging protocol group, or applied protocol is using the toolbar buttons and shortcuts:

- The buttons for applying previous Hanging protocol and next Hanging Protocol buttons may be displayed in Viewer toolbar on the left and the right side of the Hanging Protocol button correspondingly:



NOTE! By default configuration, the Prev. HP button, and Next HP button are disabled in system settings.

- Shortcuts **ALT+V** and **ALT+C** can be used to apply correspondingly the next and the previous hanging protocol from current hanging protocol group.



NOTE! The ALT+V and ALT+C shortcuts may be used even if Prev. HP and Next HP are disabled in system settings.



- The Next CP (Comparison study) button may be displayed in toolbar, if the Hanging protocol foresees the iteration through comparison studies. Clicking the button displays the next comparison studies images in the viewports, that displays the comparison study. Shortcuts **Backspace** is assigned to the Next CP button by default.



NOTE! The Next CP (Comparison study) functionality is available only in Hanging protocols version v2.

- If the multi series protocol is applied, the system automatically creates multi series viewports for the study and, if specified in the protocol, comparison study. Multi series layout shortcuts **PageUp**, **PageDown**, **Alt+PageUp**, and **Alt+PageDown** may be used to quickly navigate through all the series of the study and/or comparison study. See section “Layout and Multi image/series” for details.



NOTE! The Multi series protocol is available only in Hanging protocols version v2.

Report



Clicking the **Report** button opens the report form. See detail requirements for report module accessibility and report form description in section “Report module”.

Info Labels



Info Labels allow the user to hide the viewport labels for image, multi-frame, or video. By default, the info labels are displayed and the **Info Labels** button is highlighted, when the Viewer window is opened. Clicking the button hides all the labels in all viewports and removes highlighting from the **Info Labels** button . Click the **Info Labels** button to show the labels again.

4D Tools



4D tools menu unites the tools for working with studies that have not only space but also time parameters.

Construct 4D series



The tool is used to create a virtual series from the study series, where the data are sorted in space and then in time. The tool can be used for both multi-series merging and single-series processing.

NOTE! The tools are available for all studies that consist of images. Unsupported formats: video, ECG, SR (text format), PDF and multiframe. Does not work with reconstructions.

The user should select the required series in the thumbnail bar. If the virtual series will be created by merging more than one series, it can be select the first, or the second, or the following series.

Then the user has to open the menu **4D tools** and the sub-menu **Construct 4D series**.

NOTE! After click menu **Construct 4D series**, the system first preloads all study's series (if it has not already done so). If the study large, this may take some time.

The system opens a virtual series creation dialog where the user can mark or unmark series.

The dialogue shows a list of study's series with:

- the same modality
- the same orientation in 3D
- the same tag "Frame of Reference UID"

as the series on which the action is selected (this series is highlighted in the list in the dialogue window).

Series that have the same number of instances will be selected by default.

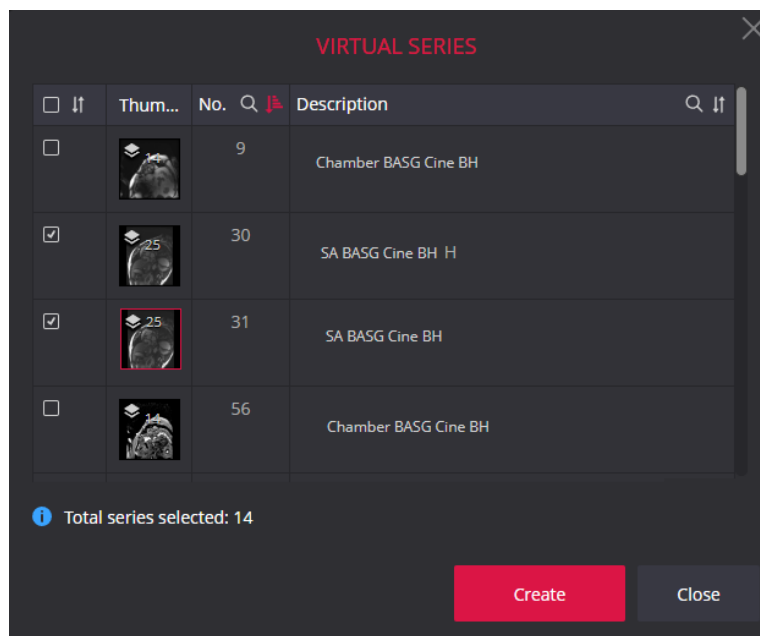

Figure 291. Creation of a virtual series. Series selection dialogue

The dialog allows sorting by certificate status, and sorting or searching by serial number in the study (the same number is visible in the thumbnail bar) and by description (DICOM tag (0008,103E)).

The thumbnail column displays thumbnails with the number of instances (thumbnail size is the same as in the thumbnail bar; can be changed in settings).

The number of selected series is displayed at the bottom of the window.

To create a virtual series, the user must select the "Create" action button.

A thumbnail is created for the virtual series and displayed at the bottom of the thumbnail list of the study, with the virtual series icon and the name "Virtual". The virtual series exists until the end of the session.

There is no limit to the number of virtual series, and the uniqueness of a virtual series is not explored.

The virtual series opens in the active viewport.

When constructing virtual series, the system rearranged instances from one or more series so that they are sorted by space and time. If there is more than one time point, a horizontal slider is displayed.

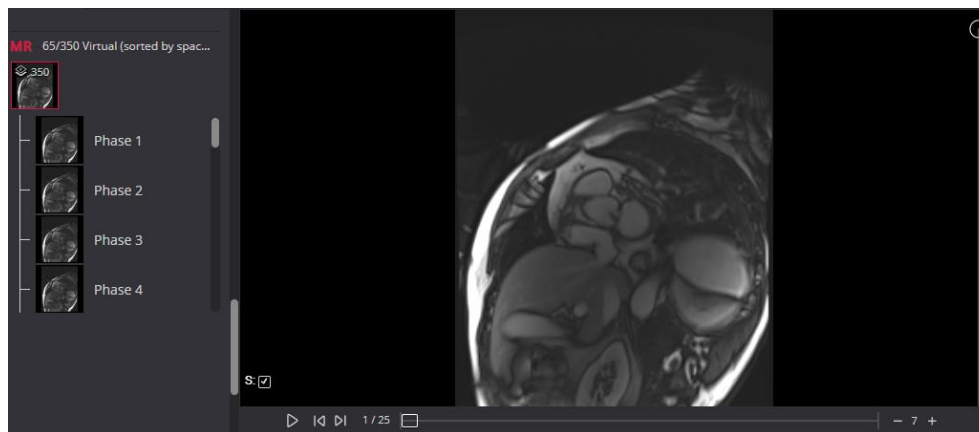

Figure 292. Creation of a virtual series. Horizontal slider

The horizontal slider is also known as the **4D slider**.

As the **4D slider** is moved, the system represents a different point in time. Meanwhile, the vertical slider shows another instance in space.

See more information about **4D slider** in the next chapter.

Show 4D slider bar



Show 4D slider bar

The **4D slider** is for steering time points in studies that have time parameters.

If studies have identified phases, but it does not make sense to have a phase controller, users can disable the controller by selecting the **4D tools** menu and the sub-menu **Show 4D slider bar**. When disabled, the setting is saved in local storage.

By default, the functionality is activated and the menu is highlighted.



NOTE! If there are time points in the Virtual Series, the **4D slider bar** is always displayed, even if "Show 4D slider bar" is disabled.

4D slider bar has the ability to play automatically through time points (or phases): the user shall click . When the button changes to a pause button , which can be used to stop playing.

It is possible to assign a Shortcuts value to a play/pause action: open the shortcut window, find "Play/Pause timeline" and assign a value. For more detailed information, please see "System menu function. Shortcuts".

NOTE! The shortcut value must be unique. For example, the value "c" is assigned by default to the **Cine** function. If the value "c" is reused for the **4D slider** play/pause function, pressing "c" will still only work for the **Cine** function.

NOTE! When **Cine** is activated, the **4D slider** is hidden. Only one mode at a time can operate: either **Cine** or **4D slider**.

It is possible to go to the next time point by selecting , or to the previous time point with .

It is possible to assign a Shortcuts value to next/previous actions: open the shortcut window, find "Go to *next* (or *previous*) image on timeline" and assign a value. For more detailed information, please see "System menu function. Shortcuts".

Shows at which time point the review is currently in progress and how many time points are available. For example: the 7th point in time (or 7th phase) out of twenty-four .

It is possible to reduce or increase play speed .

Presenter tool



The presentation tool helps the user to temporarily mark an area of interest in a viewport to share knowledge with colleagues or students. The user can link one of the mouse buttons by selecting from three options:

- Fading line,
- Fading arrow,
- Draw.

The first two certificates expire automatically after a set period of time. Selecting "Draw" keeps the highlight drawn by the user until the user selects "Clear All".



Figure 293. Presenter tool

The user can enable Laser pointer, which adds a dot to the cursor to help focus attention on the cursor position



The user can choose from 5 colours.

The colours that are selected from the menu are configured in the settings. It is also possible to change the fading time and the thickness of the line/arrow.



NOTE! Lines, arrows or curves drawn by the user are not redrawn when the layout is changed and remain on the screen where the user drew them.

Special views

The section describes the image types that may be included in DICOM file and that needs the special handling when opened in viewer's window.

ECG module

This module allows you to view DICOM ECG wave data.

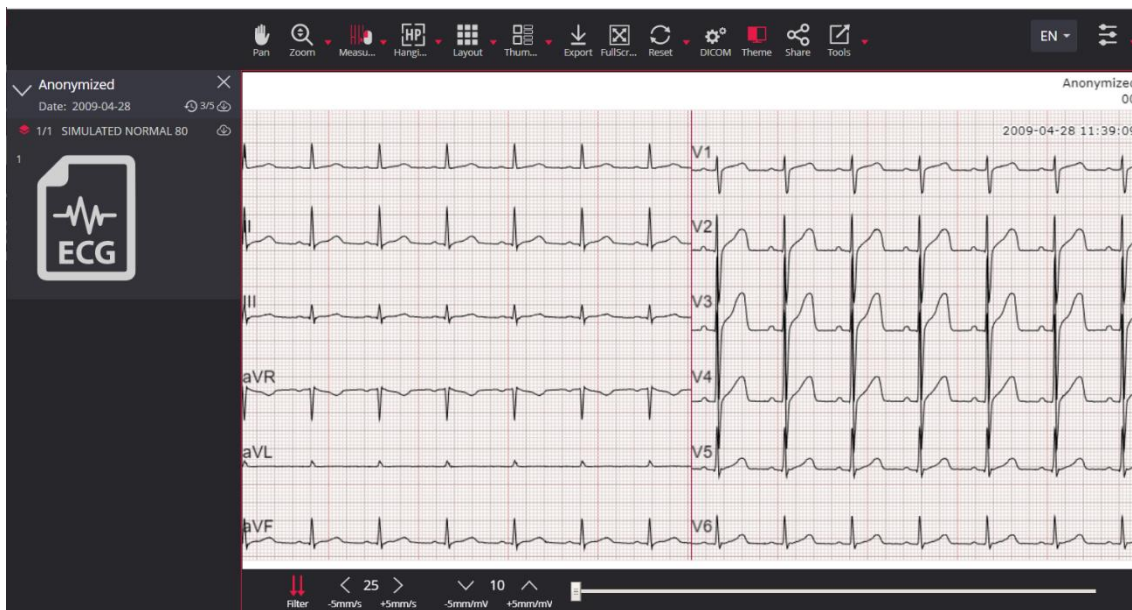

Figure 294. ECG viewer window

The section describes ECG measurements and ECG viewport toolbar. See the description of main Viewer window toolbar for other tools.

ECG Viewer window has different **Measure** menu:

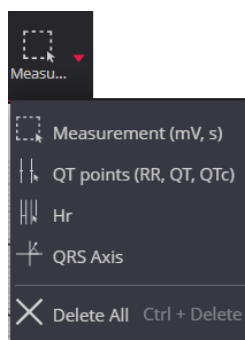
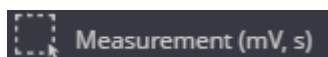

Figure 295. ECG measure tools



The **Measurement** button is used to measure the duration (first number, 0.75 s in the example) and amplitude (second number, in this case 1.18 mV) of the selected ECG segment, and to calculate the heart rate per minute (third number in the example, 80 bpm). To measure the values:

- select **Measurement** tool,
- hover the mouse cursor on the point where you want to start the measuring,
- press the selected mouse button and drag the cursor to desired position,
- release the mouse button when the cursor is on the point where you want to end measuring.



Figure 296. Using Measurement (mV, s) tool

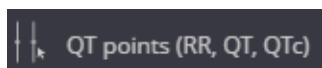

The **QT points** tool (duration of the electrical systole) is used to measure the QT intervals (RR, QT, QTc) of a selected ECG fragment. To measure the intervals:

- select **QT points** tool,
- hover the mouse cursor over the start-point of the Q wave and click the selected mouse button,
- hover the mouse cursor over the end-point of the T wave and click the selected mouse button,
- hover the mouse cursor over the start-point of the next Q wave and click the selected mouse button.

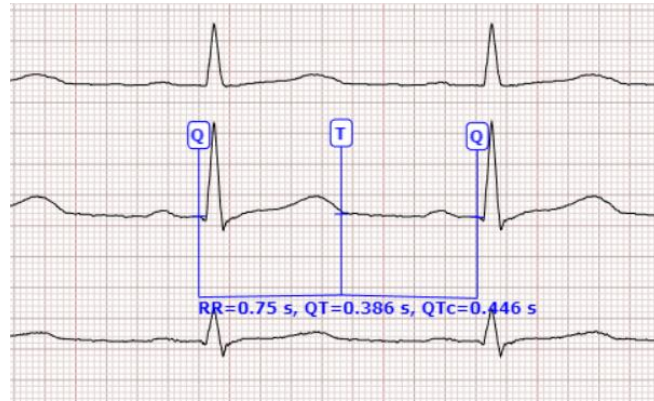

Figure 297. Using QT points tool



The button **HR** is designated to measure heart rate and visually estimate its irregularity. To measure:

- select **HR** measurement tool;
- hover the mouse cursor over the peak of the R wave and click the selected mouse button,
- hover the mouse cursor over the peak of next R wave and click the selected mouse button,
- now you can compare given interval with other R waves.



Figure 298. Using HR measurement tool



The **QRS Axis** is used to measure cardiac interventricular partition and ventricular depolarization spreading. Measurement is performed on one or more complete segments of lead I and aVF lead. To measure:

- select **QRS axis** measurement tool,
- hover the mouse cursor over the isoelectric line before P wave and click the selected mouse button,
- hover the mouse cursor over the isoelectric line after T wave and click the selected mouse button.

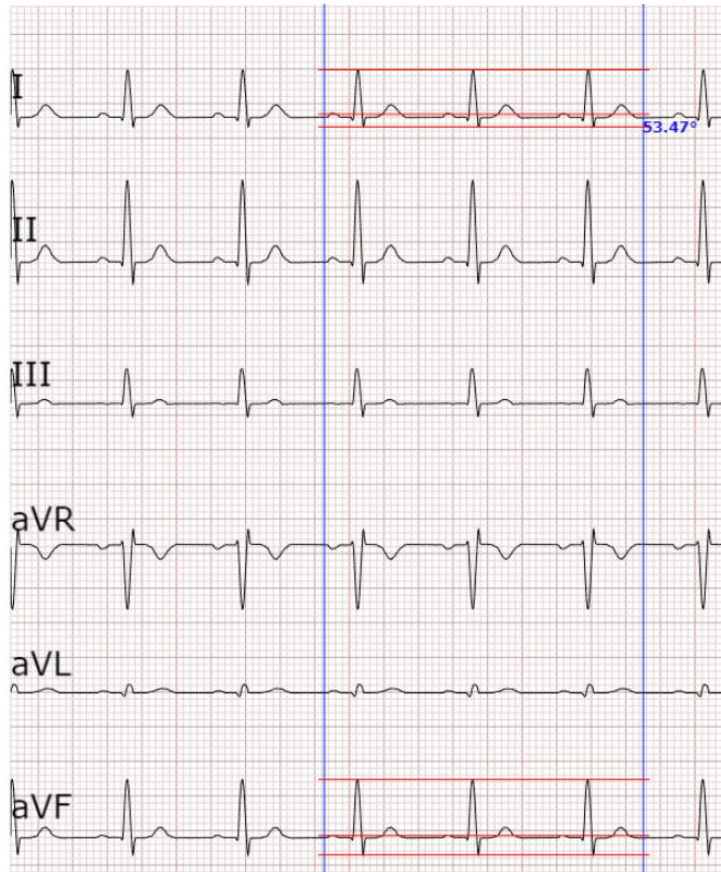

Figure 299. Using QRS Axis tool



The **Delete All** menu is used to remove all measurements.

Description of ECG viewport toolbar's tools:

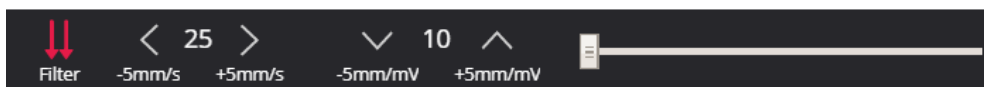
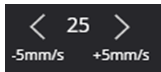

Figure 300. ECG viewport toolbar



Filter function is used for the following:

- to trim the edges of unnecessary points (points to the first spike that has no importance);
- to trim high and low frequency signals applying low-pass and high-pass frequency filters under the "Filter Low Frequency" (003A,0220) and "Filter High Frequency" (003A,0221) tags;
- to eliminate baseline wandering interference;
- filters out specified frequency signals adjusting band-stop filter by **Notch Filter Frequency** (003A, 0222) tag.



Change horizontal scale (mm per second).

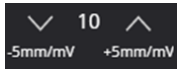

Change vertical scale (mm per mV).



ECG view scrollbar.

SR view

SR view enables to view structured reports.

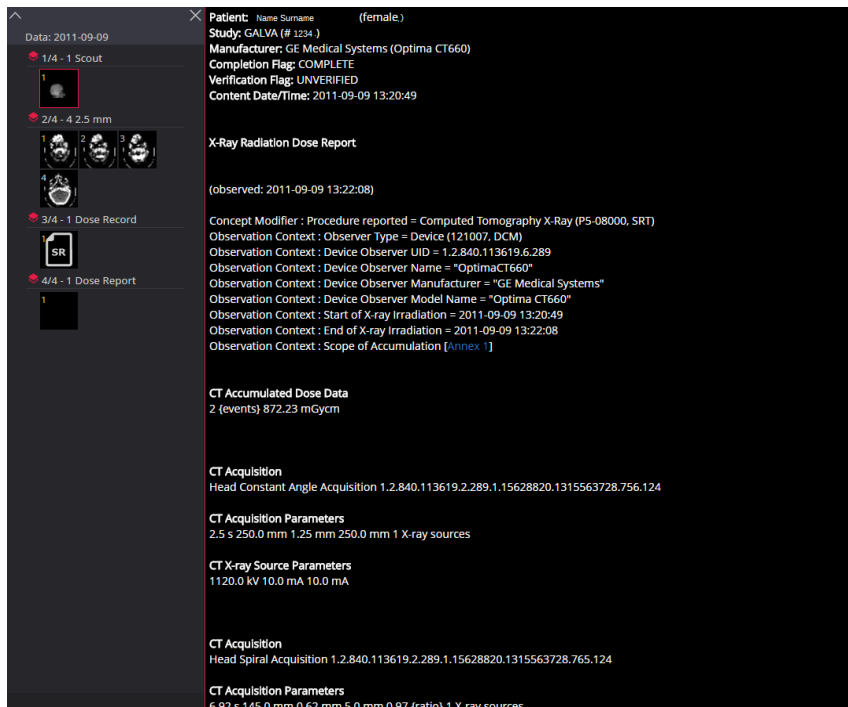

Figure 301. SR viewer window

SR window displays standard DICOM Structured Reports.

NOTE! The SR viewport does not support the html formatting. Converting the html content to text may be configured in system properties.

NOTE! Contact your system administrator, if there are SR documents included in series of other modality, and you need these SR documents to be displayed in a separate series.

PDF view

PDF view enables to view PDF files encapsulated in DICOM format.

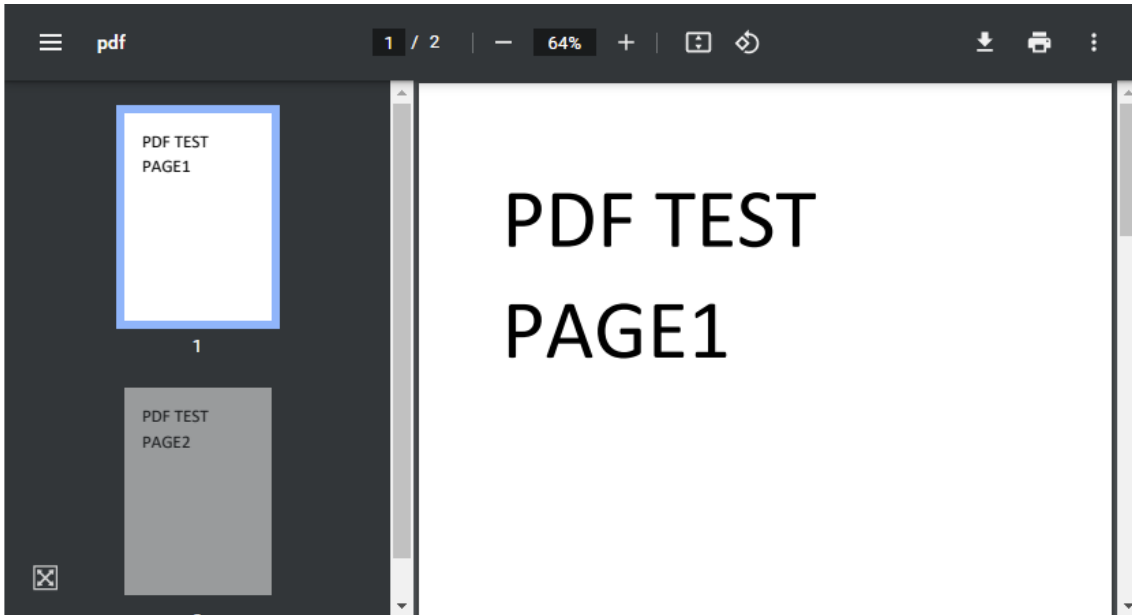



Figure 302. PDF display

CAUTION! PDF file is opened with default PDF reader. Some Web browsers have built-in readers. In other cases, the additional software for pdf reading and displaying, like Adobe Acrobat Reader, should be deployed in user workplace.

NOTE! Use the full screen button  at the bottom left corner of the pdf viewport to maximize and minimize the viewport, as the double click maximize does not work in the pdf viewport.

Video view

Software enables to view video files, MPEG2 and MPEG4 (H.264), encapsulated in DICOM format.

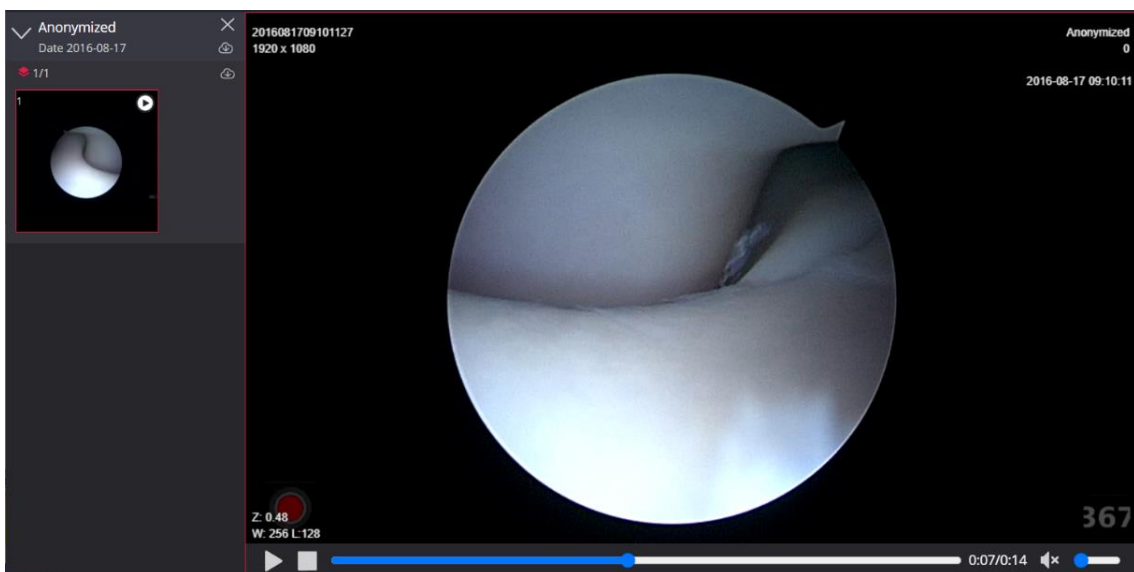



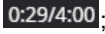





Figure 303. Video player

The play icon  is displayed on the thumbnail of video image. The standard video player is used for opening and playing video.

Toolbar for controlling the video playing is displayed at the bottom of the viewport:

- To switch the video playing off or on, click Pause  or Play  button. The button icon changes correspondingly to the current play status;
- To navigate quickly to the particular place in the video file, click on timeline, or drag the timeline cursor , or hover the mouse pointer over the timeline and scroll the mouse wheel. If timeline is used to view video by instance, the video playing is paused, if it was switched on. After finishing the actions with timeline, the video playing is automatically switched on. The time played from the beginning of the video and full time of video is displayed on the right of the timeline ;
- To stop playing and set the player to the beginning of video file, click the Stop playback  button;
- To switch the volume Off , or On , click the volume icon. To change the volume of the played video, drag the volume bar cursor or click on the volume bar .

Multi-frame view

Software enables to view multi-frame images, encapsulated in DICOM format.



NOTE! By default, the system displays enhanced multi-frame image of CT, MR, NM, MG, or OPT modality as a series of images, and system is configured to not show the image thumbnails for the multiframe that is displayed as series of images.



CAUTION! Depending on application configuration, in case of corrupted frame the system may either show warning, or ignore the corrupted frame and show the last not corrupted frame instead. Contact your system administrator for system configuration.









Figure 304. Viewing multi-frame image

The play icon  is displayed on the thumbnail of multi-frame image.

System automatically starts loading of instances, when the multi-frame image is opened in the viewport. The loading progress bar is displayed on top of the timeline .

System automatically starts playing multi-frame instance when loaded, if multi-frame AutoStart is configured in settings.

Toolbar for controlling the multi-frame playing is displayed at the bottom of the viewport:

- To switch the multi-frame playing off or on, click Pause  or Play  buttons. The button icon changes correspondingly to the current play status;
- To navigate through the multi-frame image by instance, use the Previous Instance , or Next Instance  buttons;
- To navigate quickly to the particular place in the video file, click on timeline, or drag the timeline cursor , or hover the mouse pointer over the timeline and scroll the mouse wheel. If timeline is used to view multi-frame image instances, the multi-frame playing is automatically switched off;
- The values from DICOM file, if available, are used to set the initial frame rate. To increase or decrease the frame rate, click '+' or '-' button correspondingly. The changed number of frames per second is displayed in toolbar , and immediately applied.

 **CAUTION!** System tries to achieve the requested fps when playing multi-frame. If achieving the requested fps is not possible due to hardware or software limits, some frames may be skipped and not displayed to the user while playing. To see all frames, reduce the fps or use instance by instance navigation.

Overlay layer

If the overlay layer data is available in DICOM, it is automatically displayed on the opened image, and cannot be hidden:

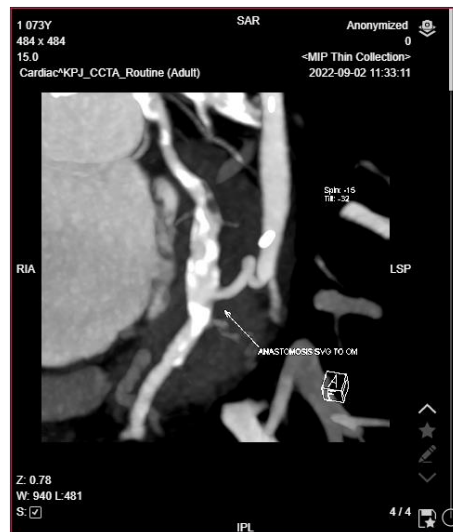



Figure 305. Image with overlay layer displayed

 **NOTE!** Showing of retired built-in overlay may be disabled in the configuration. Contact your system administrator, if overlay data is not displayed.

MedDream DICOM Viewer Chrome browser extension for multi-monitors

Requirements

- MedDream DICOM Viewer multi display browser extension requires Google Chrome browser version 52 or newer.
- Multi display requires more than one display.
- Recommended to have monitors with the same resolution (and Windows PC - the same scale), to expand browser content to correct size and position.

Extension installation

1. Extension can be found here:
 - Open Google Chrome Properties -> More tools -> Extensions:

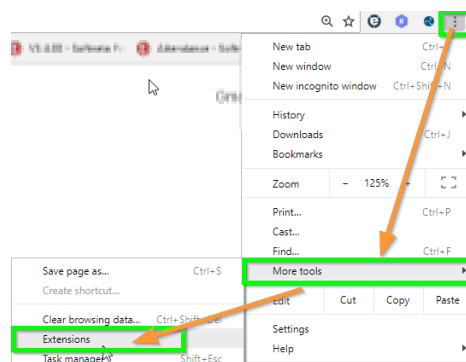

Figure 306. Chrome properties

In opened window select Extensions (in the left upper corner) -> Open Chrome Web Store

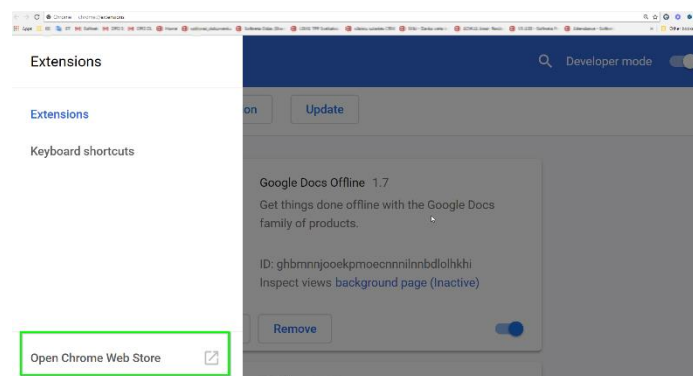

Figure 307. Chrome web store

- Go directly to Google Chrome extensions website -> <https://chrome.google.com/webstore/category/extensions>
2. Search for MedDream browser extension: type “meddream” or “multi-monitors” in the search field.

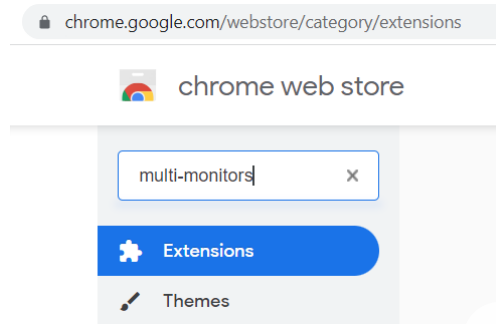



Figure 308. Filtering MedDream extension

3. Find the “MedDream extension for multi-monitors” in Extensions list, select to add the extension by pressing the **Add to Chrome** button, and confirm the installation.
4. The extension is added to the Chrome browser:
 - the extension icon  is displayed in the browser’s extensions toolbar,
 - the notification about possibility to manage the extension by clicking on the icon, or by finding the extension in the extensions list under Extensions menu, is displayed.

Extension configuration

1. Open the extension options window by clicking the extension icon  the In Google Chrome browser’s extension toolbar in the right upper corner, or by opening the extension from extensions list, and selecting the extension options.

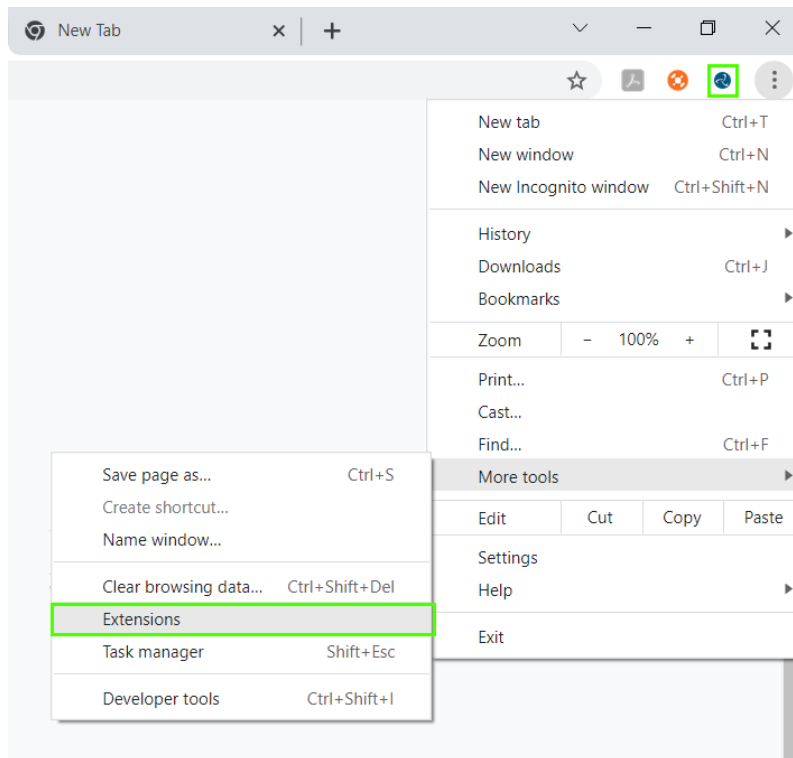

Figure 309. Accessing the options of the added MedDream extension

NOTE! Please note, that parameters are stored in browser local storage, thus after deleting temporary files should be set up again.

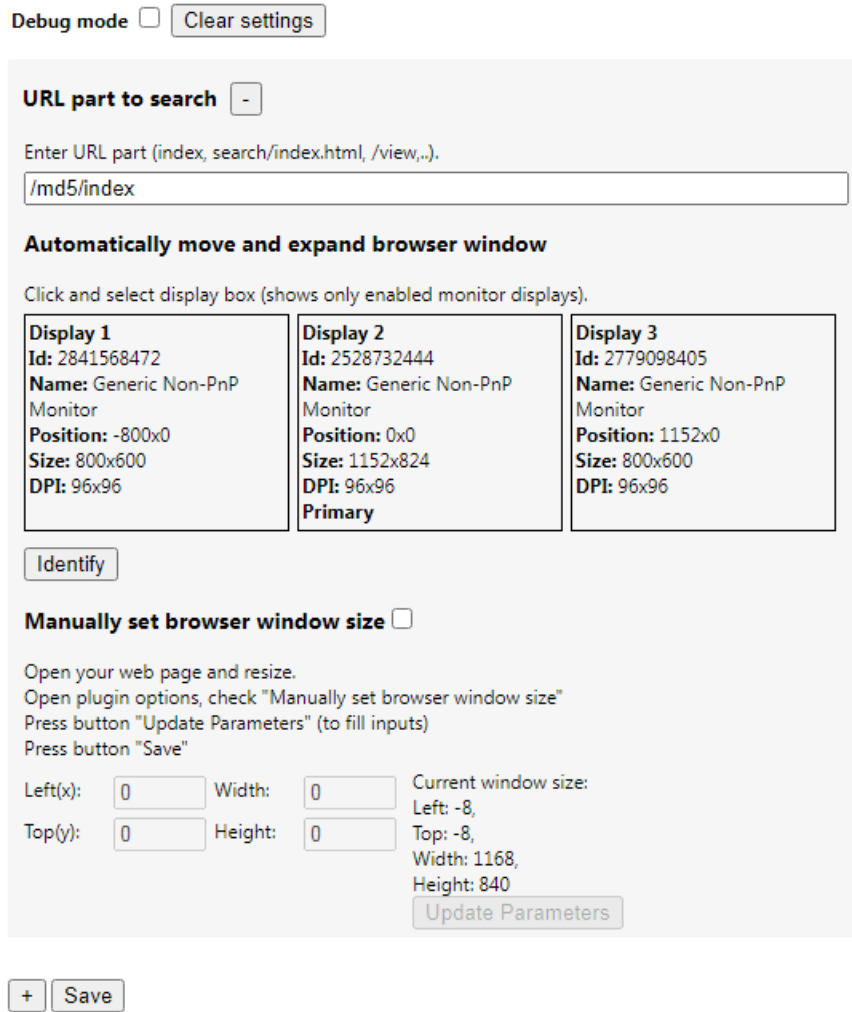



Figure 310. MedDream extension options window with 3 monitors

2. The user can change the following options:
 - Debug mode:
 - Check the **Debug mode** check box to inspect extension logic (find URL) and calculations (set window position and size). In console window, will display information about founded window and options that will try to apply.
 - Pressing the **Clear settings** button resets options and clears all saved settings. Extension is using [chrome.storage.local](https://developer.chrome.com/docs/storage/local/) to save all data.
 - URL part to search:
 - Write appropriate URL context path or part in entry field. This will be used to find matching URL in new opened or refreshed windows.

NOTE! Settings will not be saved, if URL context path is empty.

- Pressing the **Remove**  button removes your created options for URL part for search.
- Automatically move and expand browser window:

- Select displays (PC monitors) to automatically adjust matching window position and size. Selected display will be marked with green color and word “Selected”:

Click and select display box (shows only enabled monitor displays).

Display 1 Id: 2841568472 Name: Generic Non-PnP Monitor Position: -800x0 Size: 800x600 DPI: 96x96 Selected	Display 2 Id: 2528732444 Name: Generic Non-PnP Monitor Position: 0x0 Size: 1152x824 DPI: 96x96 Primary	Display 3 Id: 2779098405 Name: Generic Non-PnP Monitor Position: 1152x0 Size: 800x600 DPI: 96x96
---	--	--

Figure 311. Display 1 monitor selected

- Pressing the **Identify** button shows display numbers in each display (PC monitor) left bottom corner. It allows to identify, in what order extension sees displays.
- Manually set browser window size:
 - Check the **Manually set browser window size** check box to set matching window position (Left, and Top inputs) and size (Width, and Height inputs). It is useful to set custom position and size if displays (PC monitors) are not the same size or different DPI.
 - Pressing the **Update Parameters** button quickly fills **Left, Top, Width** and **Height** inputs with values of current active window. If the user opens a new window, position and resize this window, and then in the same window opens extension option window, the calculated current window size and position should be displayed.



NOTE! Settings will not be saved, if position or size inputs are empty.

- Pressing the Add button adds another **URL part for search block** options. This allows different URL have different window size and positions.
 - Pressing the **Save** button saves all options.
3. Option setting workflows:
- Set to automatically move and expand browser window:
 - Open MedDream extension option window.
 - Fill **URL part for search** input with matching URL part.
 - Click on desired displays in **Automatically move and expand browser window**.
 - Press button **Save** and try open or refresh your window.
 - Manually set browsers window size:
 - Open your MedDream viewer window which you want to expand on more than one display.
 - Move to desired position and resize browser window.
 - Open MedDream extension’s option windows.
 - Select checkbox **Manually set browser window size**.
 - Press button **Update Parameters** to fill inputs(top, left, width and height)with current window size or fill manually.
 - Press button **Save** and try open or refresh your window.
 - **Examples.** When MedDream DICOM Viewer will be opened, the extension detects context path and automatically seizes web browser window in specified displays. It is recommended to use appropriate thumbnail layout like Thumbnail Top or Thumbnail Down.

NOTE! If using multiple viewports layout with several monitors in Chrome browser and with window placement allowed, the system displays the whole viewport inside one monitor, and maximize the viewport inside one monitor.

NOTE! For proper viewports placement in several monitors, the monitor resolution and window scale must be the same.

NOTE! When opening MedDream for the first time on a particular browser, you should get a prompt that the website wants “manage windows on all your displays”, and then click “Allow”. If not prompted, or previously blocked, this can be adjusted by clicking the “lock” icon near the URL, choosing “Site settings” and looking for “Window management” there.

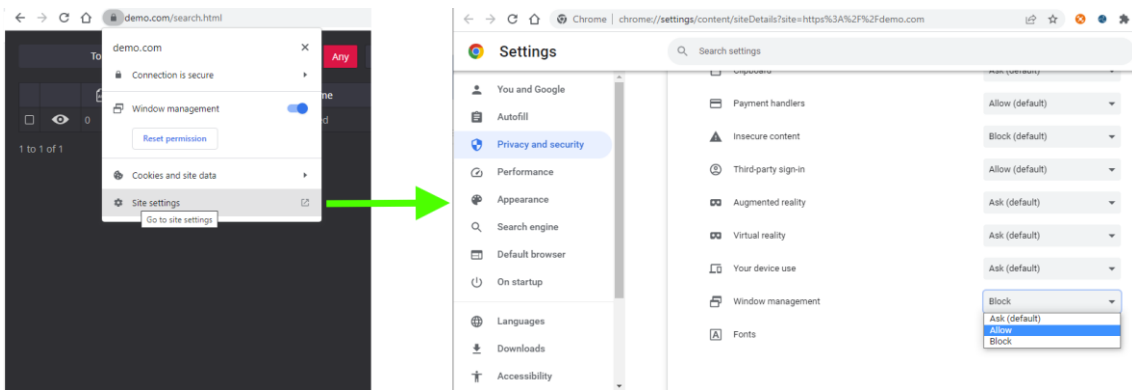

Figure 312. Configuring window management



Figure 313. MedDream DICOM Viewer on 2 displays



Figure 314. MedDream DICOM Viewer on 3 displays

Size and position of window

Modal dialog

Each modal dialog in the system is designed to fit one of the width groups:

- narrow dialog with a width of 570 pixels,
- medium dialog with a width of 750 pixels,
- wide medium dialog with a width of 850 pixels,
- wide dialog with a width of 1200 pixels.



NOTE! The default width of each width group may be changed in configuration.

By default, system opens the dialog in designed or configured width for this group and aligns it horizontally in the center of the parent window, and vertically at the top of the parent window. If the default dialog size or position is inconvenient, for example in large monitors, or when multiple monitors are used, the user can change it.

To change the width of the dialog window, perform the following:

- hover the mouse pointer over the grey triangle at the bottom right corner of the dialog window (the cursor should obtain the resize cursor look),
- press the right mouse button, and drag the mouse right or left to change the size of the dialog window,
- release the mouse button when the dialog has the preferred size.



Figure 315. Modal window resizing



NOTE! The dialog height may be changed only for dialogs with dynamic content resize. If needed, the separate height may be set for any dialog window in system configuration.

NOTE! By default, the width is changed for all the dialogs, that belong to the same width group. If needed, the separate width may be set for any dialog window in system configuration.

NOTE! The new size of the dialog is saved in browser local storage at the dialog close and is applied next time the dialog is opened.

To change the place of the dialog window in the parent window, perform the following:

- hover the mouse pointer over the title of the dialog window (the cursor should obtain the move cursor look),
- press the right mouse button, and drag the dialog window,
- release the mouse button when the dialog is in the preferred position.



Figure 316. Changing the modal window position

NOTE! The system saves the distance from the top left corner of the parent window in browser local storage on dialog close and opens modal dialog at this place of the parent window next time.

Non-modal windows

Non-modal windows do not disable the main content and the user can continue interacting with the viewport.

The size depends on the features available in the window, and by default it is displayed in the top right corner of the viewer. If the user changes the size and/or position of the window, the next time the window will be based on the saved parameters.

The user can move, resize, minimize, or close the non-modal window.

To reduce or enlarge the window, select the triangle  in the lower right corner of the window. Then the cursor changes to a two-way arrow, press the left mouse button, and move in any direction without releasing the button.

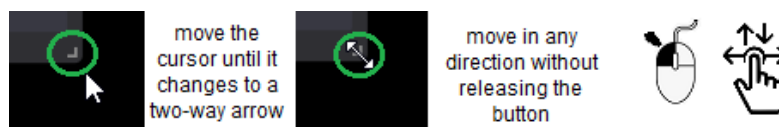

Figure 317. Resizing the non-modal window

If the non-modal window covers the view, you can change the position of the window: hover over the top of the window until the cursor changes to a four-way arrow, then press the left mouse button and move in any direction without releasing the left button.

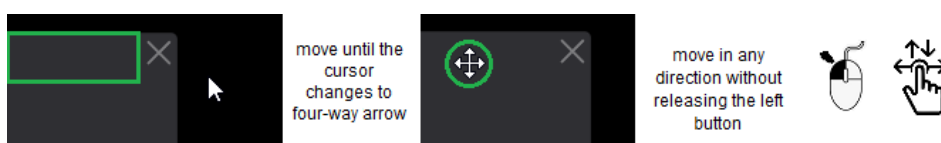



Figure 318. Changing the non-modal window position

If you are temporarily not working in a non-modal window, you can minimize it by clicking . To resume the action, click again  to maximize the window.

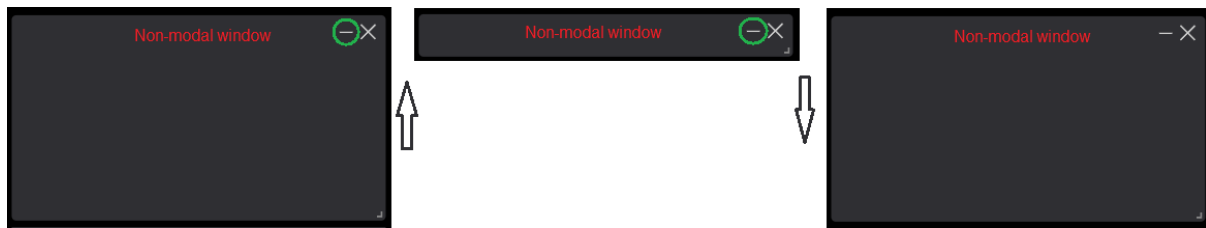





Figure 319. Minimizing the non-modal window

To close the non-modal window, press .

Export and Forward

Clicking the export  menu in Search window or Viewer window opens the Export window. Clicking the forward  menu in Search window or Viewer window opens the Forward window.

 **NOTE!** Forward and Export functions are not available in Search results window if working in mobile mode.

 **CAUTION!** Export, and Forward functionality may be disabled. Contact the system administrator to verify the configuration, if export or forward is missing.

You should select the studies that you are going to export or forward in advance. The study selection in Search window is done by marking the tick-box as described in section “Search of studies”. The study selection in Viewer window is done by activating the required viewport as described in sections “Forward” and “Export”. The selected studies are displayed in export or forward window. The studies list contains the following information about the study:

- **ID** - patient's identification number,
- **Name** - patient's name and surname,
- **Modality** - the method which was used to obtain the study images (modality),
- **Description** – the study description,
- **Date Time** – study date and time,
- **Source AE** – device from where the study was sent to the PACS.

Forward window

To send the selected studies to the remote DICOM device, click the **Forward** button. The Forward window is displayed:

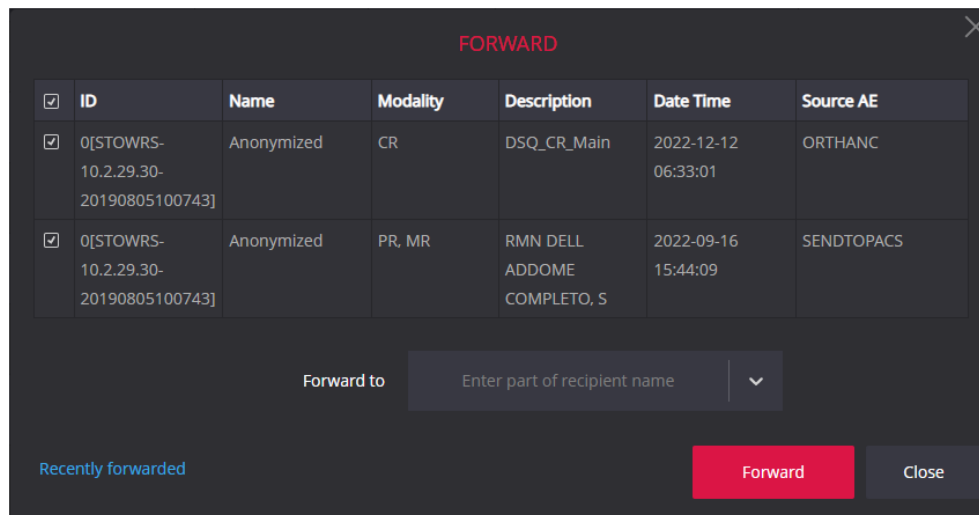

Figure 320. Forward window

Studies list at the top of the window contains the studies that are available for forwarding. If no studies are available, the “Empty list” message is displayed. The checked tick-box in the first column indicates the studies, that are marked for forwarding:

- All the studies are marked for forward, if the Forward window is opened from Search window;
- Either one, or all the studies may be marked for forward, if the Forward window is opened from Viewer window (see detail description in section “Forward”).

To change selection for the particular study, click the tick-box next to the study. The selection all the studies, that currently displayed in the list, may be changed at once by clicking the tick-box in the header of the first column.

The forward destination devices are listed below the studies list in **Forward to** expandable list:

- The list contains all the devices that are configured as forward destinations in system settings.

! **NOTE!** Each PACS device may have different forward destinations configured. If studies from different PACS are marked for forward, only the forward destinations, that are common for all the PACS, are displayed in the forward destinations list.

- To expand and view the list, click the chevron icon on the right.
- To search for specific device, enter the text in recipient search entry field above the devices list: the list is expanded and automatically filtered according to the entered text:

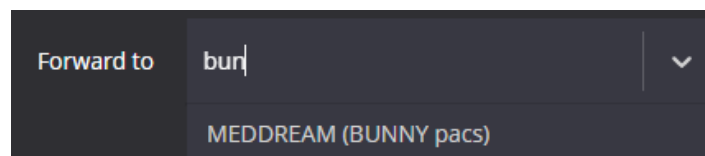

Figure 321. Searching for the forward destination

- To select the device, click on it in the expanded list.

! **NOTE!** For proper forward functioning the forward destination should be properly configured and the device should support DICOM saving functionality.

Click the **Forward** button in forward window to start the study forwarding process:

- if either studies, or device list is empty, the process is not started and the error is displayed;
- if the forward is started, the information message about initiated forward process is displayed, and the Forward button is temporary disabled while the forward process is ongoing:

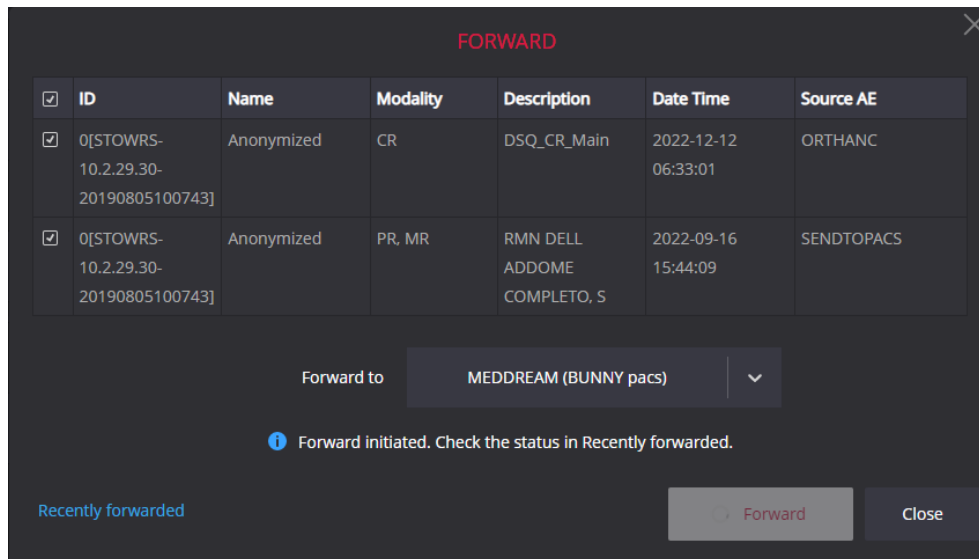

Figure 322. Information about initiated forward process

Click **Recently forwarded...** link in Forward window to see the status of the initiated forward processes:

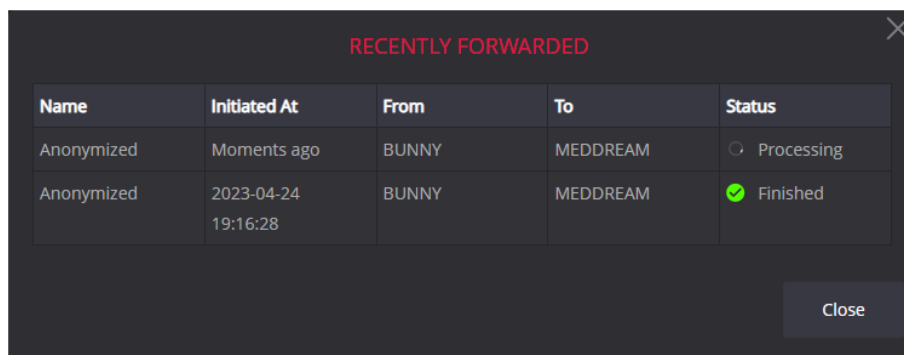

Figure 323. Forward processes list in Recently forwarded window

The forward processes list contains the following information about each forward process:

- **Name** - patient's name. Multiple commas separated names are displayed, if several studies for different patients are forwarded;
- **Initiated at** - date time, when the forward process was initiated. For processes, that are initiated less than 1 minute ago, the value *Moments ago* is displayed;
- **From** – the name of storage from which the study is forwarded. Multiple commas separated names are displayed, if several studies from different storages are forwarded;
- **To** – forward destination;
- **Status** – status of the forward process. The possible values:
 - Waiting to be picked up – waiting for response from forward service;

- Preparing - forward process initialization, that might take a long time in some cases, is in progress;
- Processing - forward process is in progress;
- Finished – forward process is finished;
- Aborted with error - error occurred during forward process.

Click **Close** button to close the Recently forwarded window and return to the Forward window.

Click **Close** button in the Forward window, if you initiated all wanted forwarding.

NOTE! The Recently forwarded window shows the last ten forward processes, that were initiated from the current browser window. You can access the forward processes list from the Forward window until the browser window is not closed.

NOTE! The Viewer windows don't share the forward processes list, and each browser window or tab has separate list in Recently forwarded window.

Export / Burn to CD/DVD window

To export the selected studies, click the **Export** button. The system displays the Export window:

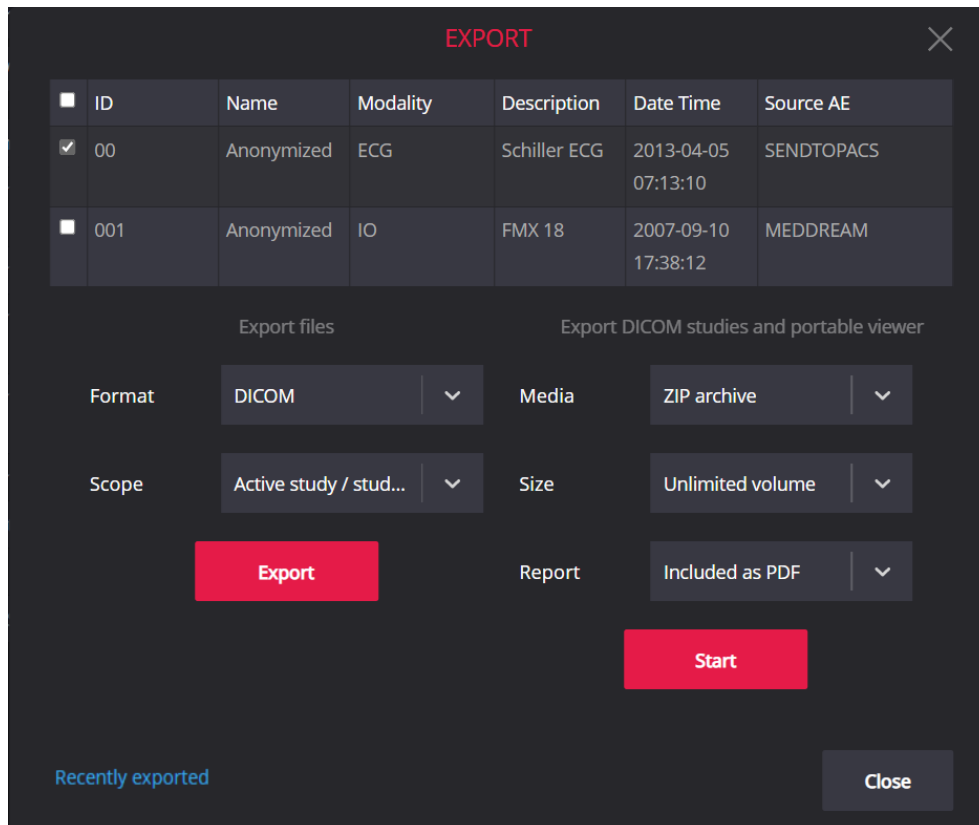

Figure 324. Export window

Studies list at the top of the window contains the studies that you have selected for export. If no studies were selected, the "Empty list" message is displayed.

If export in the Viewer window is selected for the currently viewed image, series, or study, only this study is marked at the Export window opening. Otherwise, all the studies in the list are marked. To change the selection, press and mark the tick-box next to the study.



NOTE! Report options field is available only if report exporting is enabled in report settings.

I. Export files

To save the selected for export studies in the archive file on the local disk, do the following:

1. Select the file saving format in the **Format** field:
 - if **DICOM** format is selected, the output archive contains DICOM files;
 - if **JPEG/MP4/pdf** format is selected, the output archive contains jpg, mp4(mpg) or pdf files, depending on image format;
 - if **TIFF/MP4/pdf** format is selected, the output archive contains tiff, mp4(mpg) or pdf files, depending on image format;
 - if **PNG/MP4/pdf** format is selected, the output archive contains png, mp4(mpg) or pdf files, depending on image format;
 - if **BMP/MP4/pdf** format is selected, the output archive contains bmp, mp4(mpg) or pdf files, depending on image format.



NOTE! JPEG/MP4/pdf, TIFF/MP4/pdf, PNG/MP4/pdf, and BMP/MP4/pdf formats are disabled in the following conditions:

- At least one study contains object of SR or ECG type, if study export (Active study / studies) is selected.
 - The active series contains object of SR or ECG type, if series export (Active series) is selected.
 - The active image is SR or ECG type, if image export (**Active image / video**) is selected.
-



NOTE! If DICOM file format is selected, the archive will include additional data. The presentation states for series images are included in active series archive. All the related data, like presentation states, key object, segmentation data, secondary captures, are included in study archive.

2. Select the export scope in the Scope field:
 - selecting the Active image / video, exports the image from the active viewport;
 - selecting the Active series, exports the series of the active image;
 - selecting Active study / studies, exports all the selected studies.



NOTE! Active image / video and Active series scopes are enabled only for active study export from Viewer window.

3. Click the **Export** button.

The system launches export process and disables the Export button, while the export process is ongoing. If you do not close the export window until the export to file is successfully ended, you can download the created archive from the export window:

- The button  for saving the created archive is displayed below Export button.
- The Export button color is changed to grey, indicating that archive with currently selected export options is already created.

 **NOTE!** You can close the Export window after initiating the export. You will be notified about the finished export in Viewer window, and will be able to download the created archives in the Recent Export Jobs window.

II. Export DICOM studies and portable viewer

The system provides possibility to export the one or more studies in DICOM file format, and save it as ZIP or ISO archive, together with portable viewer software. All the study related data, like presentation states, key object, segmentation data, secondary captures, are included in study archive.

 **NOTE!** The viewer may be included in archive, if the appropriate viewer software is provided and system administrator configures to enclose it in export archive.

To export the selected studies, do the following:

1. Select output archive type in **Media** field:
 - by default, **ZIP archive** option is selected;
 - select **ISO disk image** option, if you need the archive of ISO format or to burn the CD/DVD disk.
2. Select archive size in **Size** field.

 **NOTE!** For ZIP archive Size selection is disabled, and Unlimited volume is selected by default.

The following media sizes are provided for ISO disk image in default system configuration:

- **Unlimited volume** format for image saving in a single file;
- **CD** format for image split to 650 MB volumes;
- **DVD** format for image split to 4.7 GB volumes;
- **Dual-Layer DVD** format for image split to 8.5 GB volumes.

 **NOTE!** The media sizes may be supplemented or replaced with other values by system administrator.

3. Select either you need to include the study's **Report** in archive:

 **NOTE!** **Report** options field is available only if report exporting is enabled in report settings.

You can select the following options:

- **Included as PDF**, if you need the study's report to be included in study's archive;
- **None**, if you do not need report to be included into archive.

 **NOTE!** **Included as PDF** option is not displayed, if no one of the studies, that were selected for export, has the saved report.

4. Click the **Start** button.

The system launches export process and disables the Start button, while the export process is ongoing. If you do not close the export window until the process is successfully ended, you can download the created archive from the export window:

- The list of created volumes and controls for saving them are displayed in Export window:

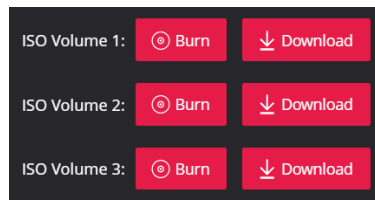

Figure 325. ISO volumes list and saving buttons

- The **Start** button color is changed to grey, indicating that archive with currently selected export options is already created.

NOTE! You can close the Export window after initiating the export. You will be notified about the finished export in Viewer window, and will be able to download the created archives in the Recent Export Jobs window.

NOTE! The **Burn** option is not displayed for ZIP archive.

NOTE! For Burn functionality, the burning software must be installed and the automatic burning software launch must be configured on user's machine.

Recent Export Jobs window

You can open the Recent Export Jobs window in such ways:

- By clicking the **Recently exported** link in Export window;
- By clicking the **Recently exported** link in notification about finished export:

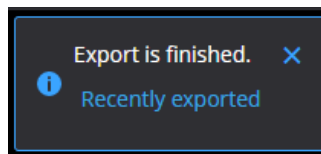

Figure 326. Notification about finished export

- By clicking the **Recent Export Jobs** item in Export drop-down menu.

The Recent Export Jobs window displays the list of export jobs:

RECENT EXPORT JOBS					
Patient Name	Initiated At	Contents	Format	Media	Download
Anonymized	Moments ago	Instance	PNG / MP4 / PDF		Download
Anonymized	2022-12-20 21:17:59	Study & Portable Viewer	ISO disk image	Unlimited volume	Volume 1: Burn Download

Close

Figure 327. Recent Export Jobs window

The list contains the information for easier identification of the export job:

- **Patient Name** - patient's name. Multiple commas separated names are displayed, if several studies for different patients are exported;
- **Initiated at** - date time, when the forward process was initiated. For processes, that are initiated less than 1 minute ago, the value *Moments ago* is displayed;
- **Contents** describes what was included into archive. It could be one instance, series, study or multiple studies. If portable viewer or report is included, this information is provided in content field;
- **Format** details either the format of exported instances for files export, or output archive format for DICOM studies export;
- **Media** provides the size of output media and is applicable only for DICOM studies export;
- **Download** displays the links for archive download. The **Download** link is displayed for ZIP archive. The **Burn**, and **Download** links are displayed for each volume of ISO archive. In case of error in export process, the error information is displayed in Download field instead of download links.

Click **Close** button to close the Recent Export Jobs window.



NOTE! The storage time of created archive depends on the system configuration. If the archive was deleted, such export job is not displayed in the Recent Export Jobs window.





NOTE! The Viewer windows don't share the export processes list, and each browser window or tab has separate list in Recent Export jobs.

Report module

NOTE! The section describes the functionality of the system reports module, which is an additional module and should be granted by license.

The Report window of the system report module is opened by clicking the displayed report icon in the results list of the Search window, or in thumbnail zone, Series modal, or toolbar of the Viewer window:

- Create report  icon is displayed, if the study does not have saved report and the user has right to edit reports.
- Edit report  icon is displayed, if the study has saved report and the user has right to edit reports.
- Open report  icon is displayed, if the study has saved report and the user has right to view reports.

NOTE! If integration with third-party reports is configured, instead of the report, that is created in the system, the third-party generated PDF report may be displayed.

NOTE! The **Report** icon is visible only if the Report module is allowed by license, system configuration, and the user has right to view or edit reports.

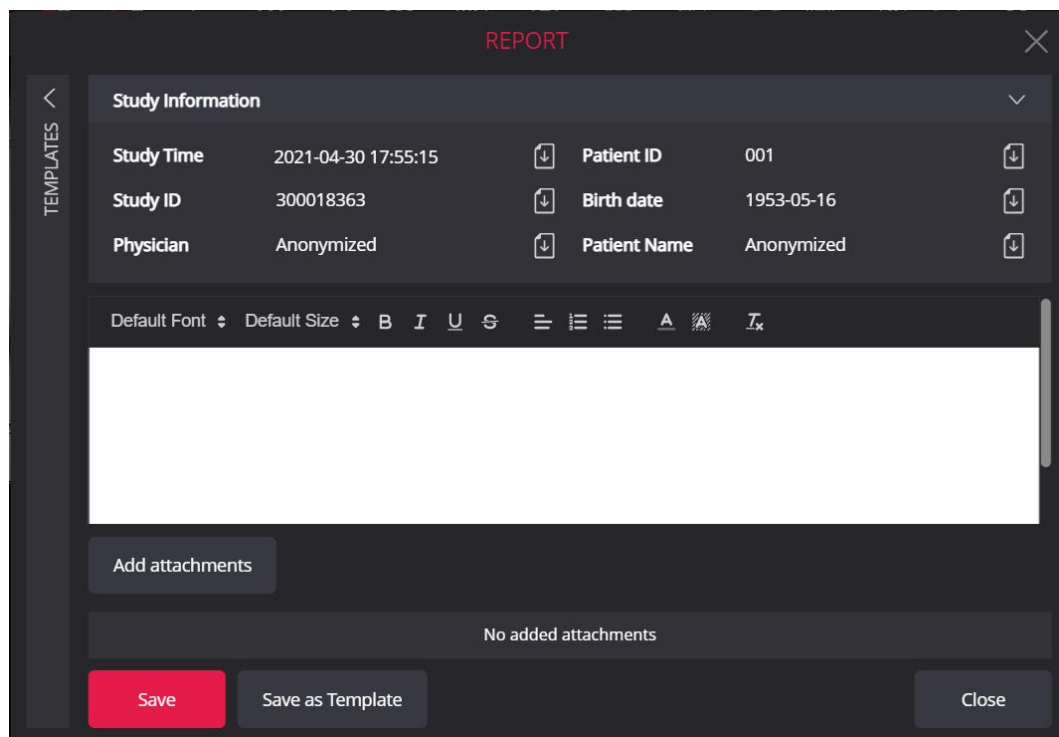

Figure 328. Report window in edit mode is opened after clicking the Create report icon

NOTE! By default, the Report window is opened as modal window. Opening Report window in separate browser tab may be configured in Reports settings (see [Settings](#)).



NOTE! The fields in the Study information may not be displayed, if the corresponding data is not obtained from the DICOM file.

By default, the Report window size is adjusted to the screen size, Study information is expanded, and Templates group is collapsed and displayed either on top, or at the left of the main report fields. You can adjust the report's window view and size.





NOTE! The changes in report window size, expand/collapse status of Templates, template group, and Study information are saved in browser local storage and are restored next time the report window is opened by the user.

You can perform the following in the Report window:

- To use and manage the report templates:
 - To expand or collapse Templates section, click the chevron icon above the Template label;
 - To open the Template window with the content of current report to be saved as template, click the Save as Template button.
- To view or collapse the study information by clicking the chevron icon on the right of the field.
- To enter and save the report for the study.
- To view and restore the previous report version.
- To print the saved report.

Creating or editing the report content:

- You can enter the report content in editor field. The text and image copy (Ctrl+C), cut (Ctrl+X), and paste (Ctrl+V) is allowed. Use the toolbar above the editor to format text.
- You can copy the Study Time, Study ID, Patient ID, Patient name, Birthday, and Physician data from the Study information to report content:
 - place the cursor in the text editor at the position where the data should be copied,
 - click the Paste to report  icon on the right of the appropriate field,
 - and the system copies the field value to the specified place.
- You can copy the content from the selected report template to the report:
 - place the cursor in the text editor at the end of the line below which you want the template content to be copied,
 - find the template in the templates list, and click the Load template to report  icon on the left of the template name,
 - and the system copies the content of the template in a new line.
- To save the report content, click the **Save** button at the bottom of the Report window. The system saves the report content – the notification about saved report is displayed above the editor, and report saving time is displayed in the first row of Study information:

The screenshot shows a report editor window with a dark theme. At the top, there is a 'Study Information' section with a dropdown arrow. Below it, a table displays various fields: Report Time (2021-05-04 17:38:31), Patient ID (001), Study Time (2021-04-30 17:55:15), Birth date (1953-05-16), Study ID (300018363), Patient Name (Anonymized), and Physician (Anonymized). Each field has a small icon to its right. Below the table, a green notification bar with a checkmark icon says 'Report saved successfully.' with a '(3s)' timer and a close icon. Underneath is a rich text editor toolbar with icons for font size, bold, italic, underline, strikethrough, bulleted list, numbered list, indent, text color, background color, and link. The editor area contains the following text: 'This is report sample.', 'Click the *Paste to report* icon on the right of the Study Time field to copy it here: 2021-04-30 17:55:15', 'The content of the Group I | Template 1 is copied bellow this line', and 'This is content of the following template: Group I | Template 1'.

Figure 329. Report content successfully saved

- You can apply all the above-described action to edit the content of the saved report either directly after saving, or if opening the previously saved report window with Edit report button. Each time you save the report content by clicking the **Save** button, the system creates a new report version and updates the saving time in the Report time field. All the attachments that were added to the previous report version are automatically added to the new report version.

 **NOTE!** All the unsaved report content changes are discarded if the Report window is closed with **Close** button.

Managing report attachments:

 **NOTE!** Attachment can be added only to the saved report, and only to the last report version.

- You can add attachments to the saved report:
 - click the **Add attachments** button,
 - select one or more files in the displayed file open dialog and close the dialog with Open button,
 - system saves attachments, and adds to the last saved report version – the notification about saved attachments is displayed above the editor, and added attachments are listed below the Add attachment button:

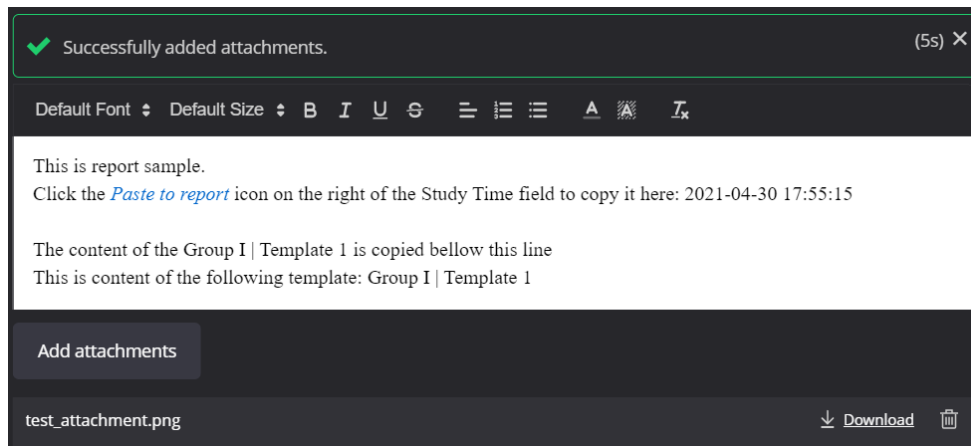

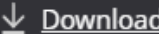

Figure 330. Report attachments successfully added

CAUTION! The size limits for one attachment file and one-time upload package, that are defined in system configuration, cannot be exceeded.

- You can remove the report attachment by clicking the Remove  button on the right of the attachment – system removes the attachment and displays notification above the editor.
- You can download the attachment to your computer by clicking the Download  link on the right of the attachment.

Viewing and restoring the previous report version:

- You can view the previous report version, if more than one report version is saved. Click the chevron icon at the right of the Report Time field and select the report version that you want to view from the report versions drop-down list:

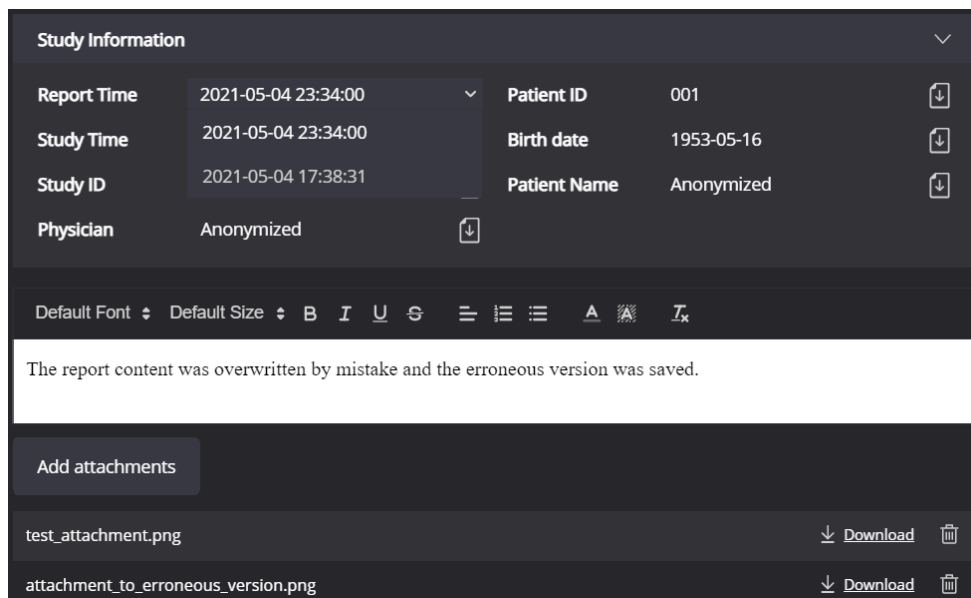

Figure 331. Selecting the report version

- System loads and shows the content of the selected report version. The attachment list displays all the attachments, that were either automatically attached when saving the version, or added to the version by the user after saving.

- You can download the attachments of the report version, view and print the report version. It is not allowed to change the content and attachments of the historical report version.

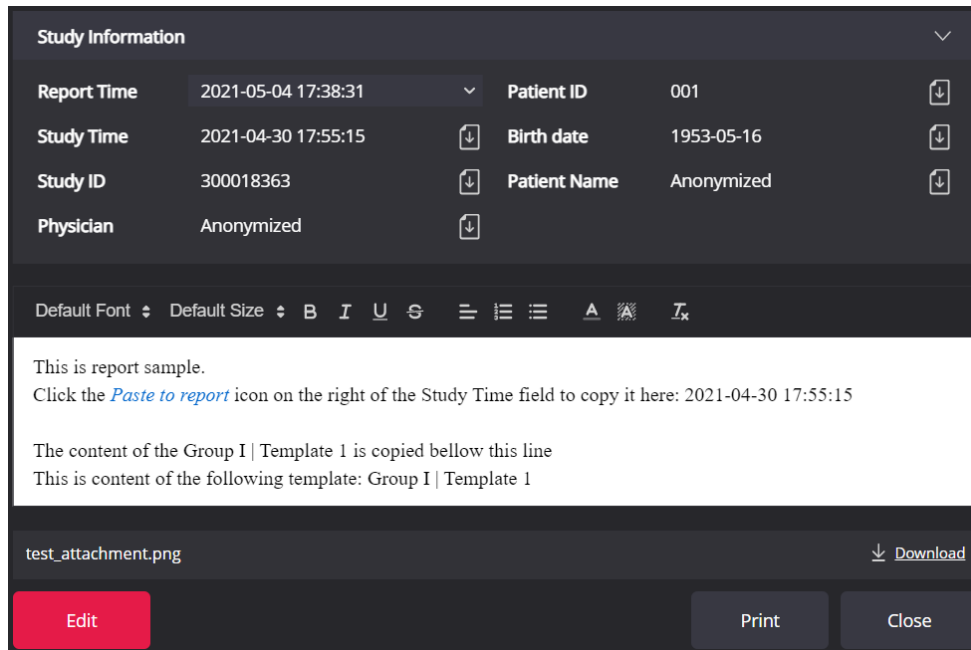

Figure 332. Viewing historical report version

- You can restore the historical report version by clicking the **Edit** button. If action is confirmed, the historical report versions is be saved as the latest.

NOTE! Attachment of the historical report version will be attached to the latest report version, if the historical report version is saved as the latest.

Printing report:

NOTE! The system prints the historical or latest saved report version. You should save the changes you have done, if you want to print them.

To print the report content, click the **Print** button at the bottom of the Report window. The system opens the report print preview in a new browser tab with the report content wrapped in the print template. The print template may include the additional data, such as company logo, users' signature, data from studies DICOM file.

NOTE! Report print template is configured by system administrator.

Viewing report:

If the user does not have right to edit report, but has right to view reports, the system opens Report window in view mode:

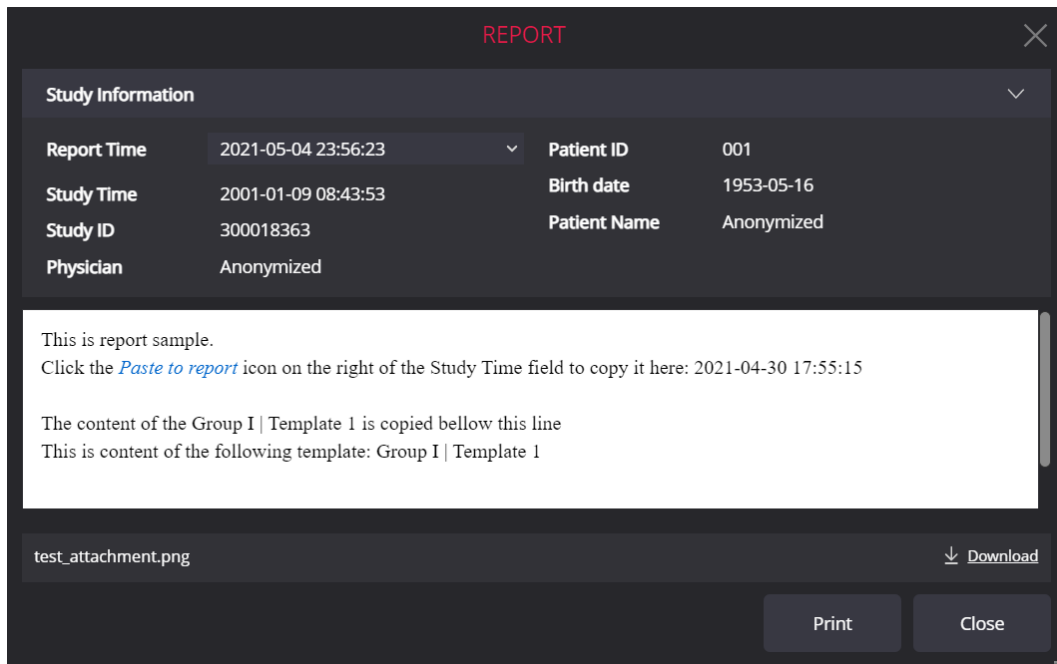

Figure 333. Report window in view mode

The user with report viewing rights can perform the following in the Report window:

- View the content of the historical or latest report version;
- Print the content of the viewed report version;
- Save attachments of the viewed report version in users computer.

Managing report templates

NOTE! The report templates are assigned to the system user and are visible only for this user.

NOTE! The report templates section in Report window is visible only if the user has rights to edit reports.

User's report templates are displayed in Templates section of the Report window. You should expand the Templates section to view the list of available templates:

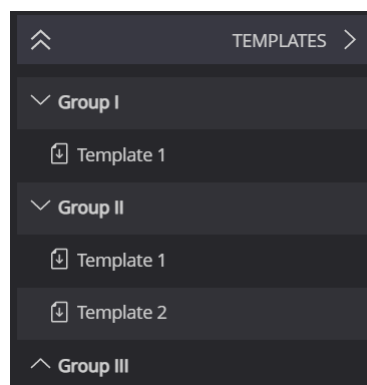





Figure 334. Templates section of the Report window

The templates are grouped by group name, and sorted in a group alphabetically by template name. You can expand and collapse the template group by clicking the chevron icon on the left of the group name. You can expand or collapse all template groups at once by clicking double chevron  icon in the templates' header row.

Hover mouse cursor over the group row to see the group management buttons . You can do the following actions:

- Press the Edit  button, or double-click group name to turn the group name to entry field and edit it directly in templates list;
- Press the Remove  button, and confirm the action to remove the templates group with all the templates in this group.

Hover mouse cursor over the template row to see the template management buttons

. You can do the following actions:

- Double-click template name to turn the template name to entry field and edit it directly in templates list;
- Press the Remove  button to delete the template. The system shows action confirmation message and deletes the template, if confirmed.

 **NOTE!** The template group will not be displayed, if the last template with this group name is deleted.

- Press the Edit  button to view and edit the template's data in Template window:

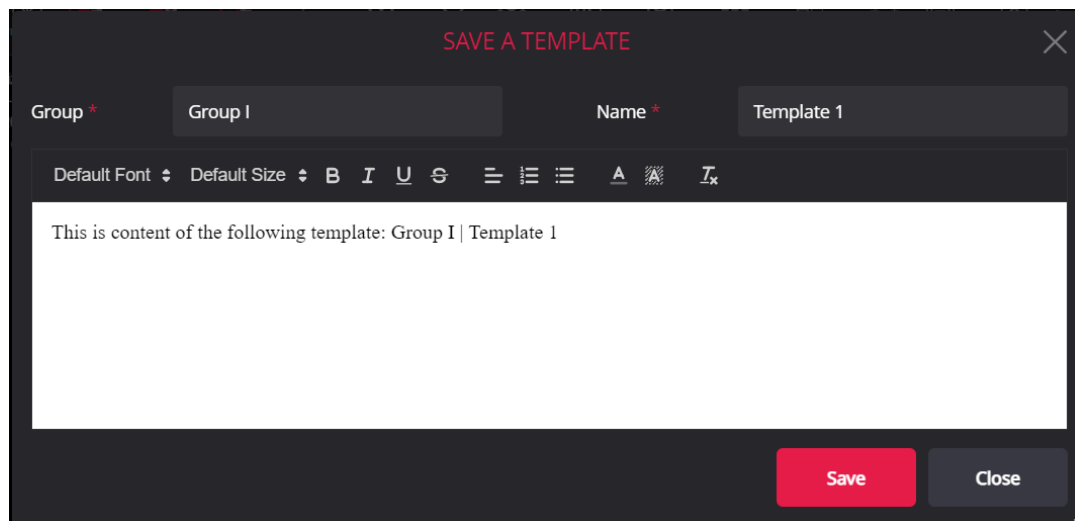



Figure 335. Report template window

 **NOTE!** To create a new template, click the **Save as Template** button at the bottom of the Report window. The system opens Report template window and copies the text displayed in the Report window to it.

You can perform the following in the Report template window:

- To enter or edit group name in Group entry field. If the entered group name equals to the already existing group name, the saved template is displayed in this group. Otherwise, a new group is displayed in template list.
- To enter or edit template name in Name entry field.

- To save the template by clicking the **Save** button. The system saves the template, closes the Template window, and displays the new or updated template in templates list.



NOTE! The changes are not saved, if the Template window is closed with **Close** button.

System menu functions

The section describes all the options that may be displayed under expandable **System** menu .

The system menu in the Search window contains options: **About**, **License Agreement**, **Help**, **Settings** and **Log Off**. The system menu in the Viewer window contains options: **About**, **License Agreement**, **Help**, **Shortcuts**, **Clear cache**, **Settings** and **Log Off**. Read the conditions, under which the one or more options are not shown, in the Search window and the Viewer window description.

About

Clicking **About** menu opens the information window:

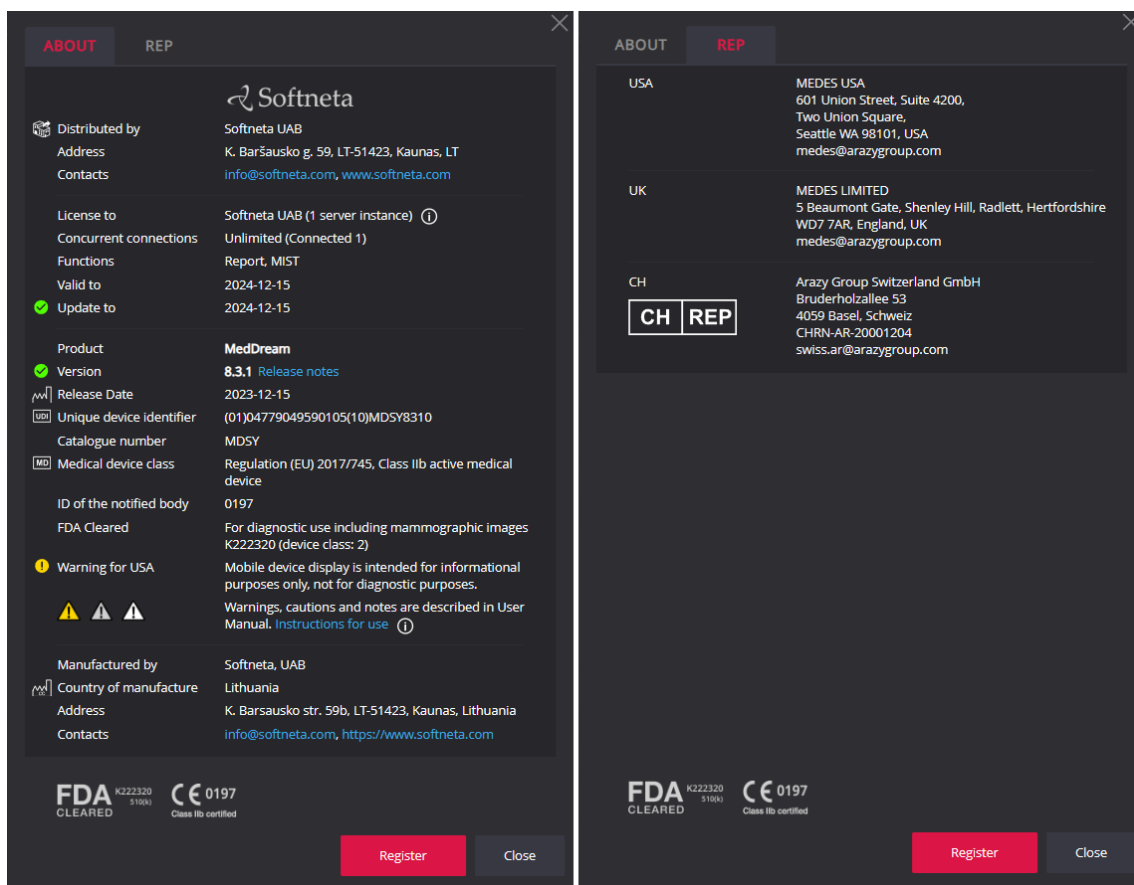





Figure 336. Information window

The information about the product identity is displayed in the following groups, and in the listed order:

- The distributor group contains Distributed by, Address, and Contacts fields, that show name and contacts of product distributor.
- The license group provides the following information about the product license:
 - **License to** contains the information about organization that owns the license of current product installation. If available, the name and contacts of the end user are displayed in the hint of the information icon .
 - **Concurrent connections** describe the number of concurrent connections that is issued for the license and the number of currently used connections. The text 'unlimited' indicates that number of connections is unlimited;

- Field **Functions** shows the software modules that are granted by the license (for example, Report module) Information about product license;
 - Fields **Valid to** and **Updates to** indicates dates, until the current license is valid and will receive updates;
 - License update status is also provided as a status icon  near the **Update to** field, and the additional information about the update is displayed in the hint of the status icon.
 - The product group provides the following information about the product and certification:
 - **Product** provides the official product name;
 - Fields **Version**, and **Release date** holds information about the installed version;
 - The versions' release notes are accessible by clicking the **Release notes** link;
 - Version update status is also provided as a status icon  near the **Version** field, and the additional information about the update is displayed in the hint of the status icon;
 - **Unique device identifier**:
 - Fields **Catalogue number**, **Medical device class**, **ID of the notified body**, and **FDA cleared mark** holds the products' certification data. Warning regarding not using mobile display for diagnostic of mammographic images is available. In addition, the CE and FDA certification logos are displayed at the bottom of the about window, and designated agents contacts are available in REP (representatives) tab.
-
-  **NOTE!** The certification information is not applicable for VET installation.
-
- Explanation of safety signs is included, with **Instructions for use** link, which opens the user manual of MedDream viewing functionalities.
 - The manufacturer group contains **Manufactured by**, **Country of manufacture**, **Address**, and **Contacts** fields, that show name and contacts of product manufacturer.

You can open the release notes modal by clicking the **Release notes** link near the version number.

You can initiate the license registration or update by clicking the **Register** button (see description in section "License registration").

 **NOTE!** The **Register** button is visible only if user has administrator right granted by user rights and Settings menu is enabled in system settings.

License Agreement

License Agreement menu opens the **Software License Agreement (EULA)** modal:

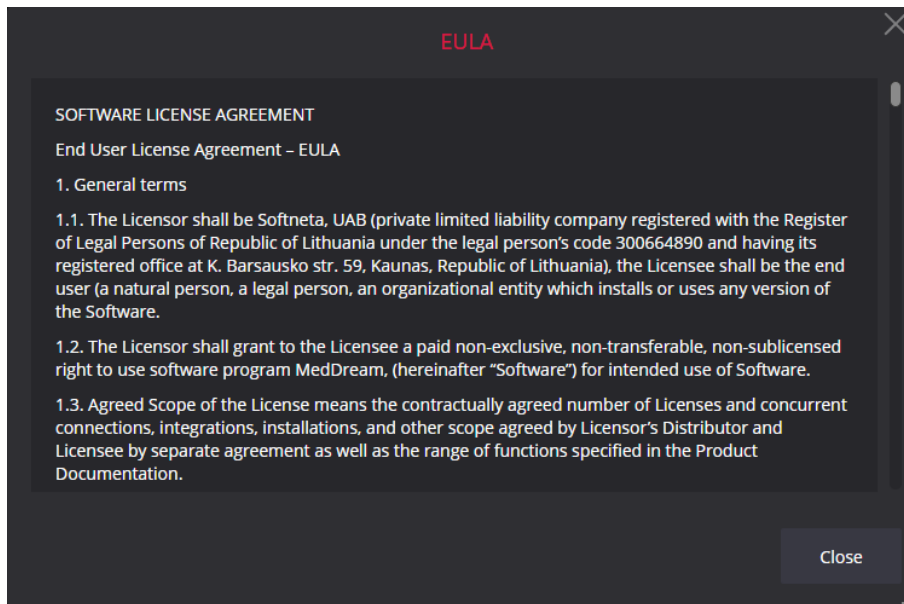

Figure 337. EULA window

Help

Help menu forwards you to the user manual of MedDream viewing functionalities. The user manual also may be accessed from the About window by clicking the **Instructions for use** link.

Shortcuts

Shortcuts menu will display modal with keyboard shortcuts.

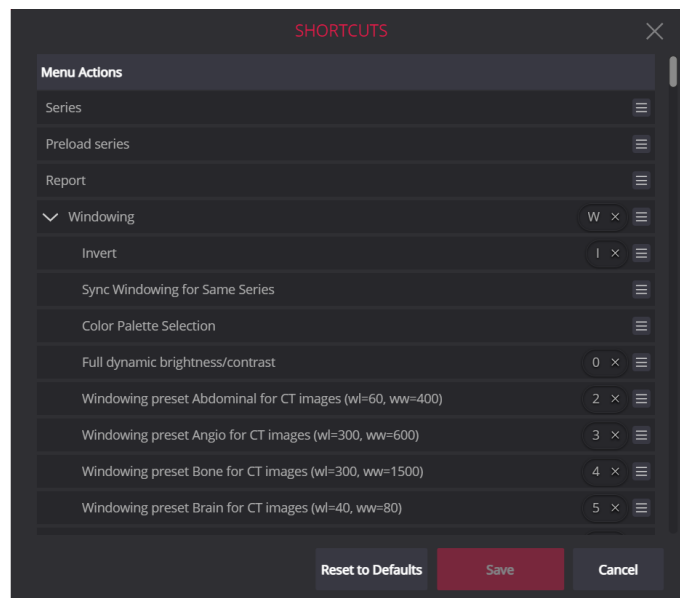



Figure 338. Shortcuts window

A *keyboard shortcut* is a sequence or combination of keystrokes on a computer keyboard which invokes commands in a software. The shortcuts window displays the commands, that have or may have the assigned shortcuts:

- If the command has shortcut assigned, the keystrokes combination is displayed for the command;

- If the shortcut may be assigned or changed for the command, the shortcut editing notification icon  is displayed on the right.

The user can configure the shortcuts:

- To remove the shortcut, that is assigned to the command, press “x” near the shortcut;
- To assign the shortcut to the command:
 - press the shortcut editing notification icon and then open the Create keyboard shortcut window

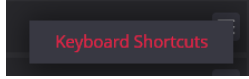
by pressing the Keyboard Shortcuts button ,

- press the keyboard or mouse keys, that you want to assign as shortcut to the command,
- the system displays pressed shortcut in the Create keyboard shortcut window,

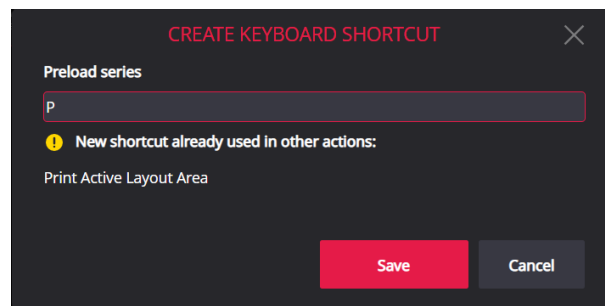





Figure 339. Create keyboard shortcut window with entered shortcut and duplicated shortcut notification

 **NOTE!** The system displays the notification, if the shortcut is already assigned to the other command. The notification does not prevent for saving the duplicated shortcut. For example, if you decided to assign the “P” shortcut for “Preload series” command, you should manually remove the shortcut from the “Print Active Layout Area” command, either before assignment, or after.

- press Save button in the Create keyboard shortcut window, if decided to assign the entered shortcut to the command,
- the system closes the Create keyboard shortcut window, and displays the new shortcut for the command in the Shortcuts window;
- To restore the default shortcuts values, press the Reset to Defaults button, and the system updates all the shortcut values in the Shortcuts window from the default shortcuts configuration;
- The Save button in Shortcuts window is activated, if there are any changes in the previously assigned shortcuts. To save the shortcut changes, press the Save button. The system permanently saves the shortcuts in the user settings.

 **NOTE!** To modify personal user shortcuts, the user should have the right to modify shortcuts, do not have the administrator right, and should be logged in with his login name.

 **NOTE!** If the user has administrator right and saves the shortcuts changes, the system shortcuts settings are modified and further used as default shortcuts for all the users. See install manual for description how to restore the system shortcuts settings to default values.

Clear cache

NOTE! The **Clear cache** menu is visible only if user has right granted and cache clearing is enabled in system settings.

To remove the cached data of the currently viewed study, click option **Clear cache** and it will lead you to the Clear Cache window:

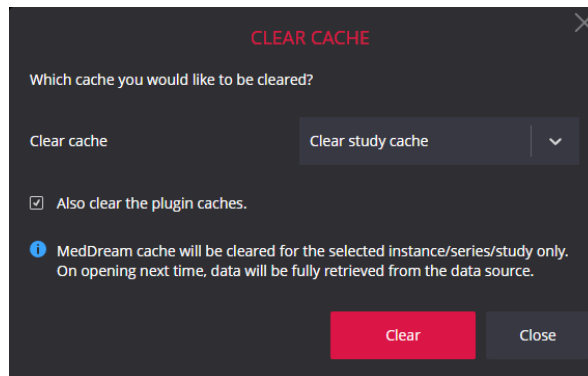

Figure 340. Clear cache window

The clear cache scope options are listed in **Clear cache** expandable list. By default, the system suggests to remove the whole study from the cache. You can clear the active instance cache, or active series cache by expanding the list and selecting the appropriate item from the list:

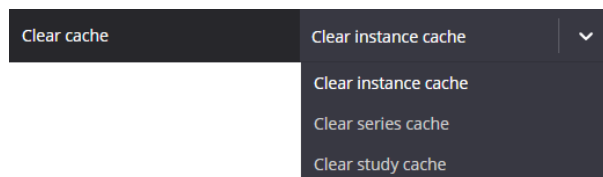

Figure 341. Cache clearing scope selection

Checking "**Also clear the plugin caches**" will also clear the plugin caches (if working through plugins).

Click the **Clear** button in Clear Cache window to initiate the removing of the selected content from the system cache.

NOTE! The cache clearing removes all the study data, that was previously preloaded to the Viewer. And only the currently viewed instances are loaded automatically.

Click **Close** button to close the Clear Cache window.

Settings

To change MedDream viewer's settings, click button **Settings** and it will lead you to the settings window. For more information see [Settings](#).

NOTE! The **Settings** menu is visible only if user has administrator right, or right to view personal settings, granted by user rights and Settings menu is enabled in system settings.

Log Off

Use **Log Off** option, if you finished working with the program. Logging off from the Search window, closes all the Viewer windows that were opened from Search window and destroys the browser session.

In case the integrated solution is used and the Search window is disabled, **Log Off** is available under the System menu in Viewer window.



NOTE! If after login the error about forbidden functionality is displayed instead of Search window, press the Log Off button, in case it is displayed on the error page, and contact your system administrator to verify the system configuration and user rights.



CAUTION! Please notice, that closing the program without Log Off (using browser window close 'x' button) is not safe and may lead to unauthorized access to medical data.

License registration



NOTE! License registration is required for legal software use. The license registration function is accessible only for users having administrator rights.

You can open the license registration window in such ways:

- By clicking the **Register** button in demo notification window. The demo notification window is displayed, if the system runs without registered license (in demo mode):

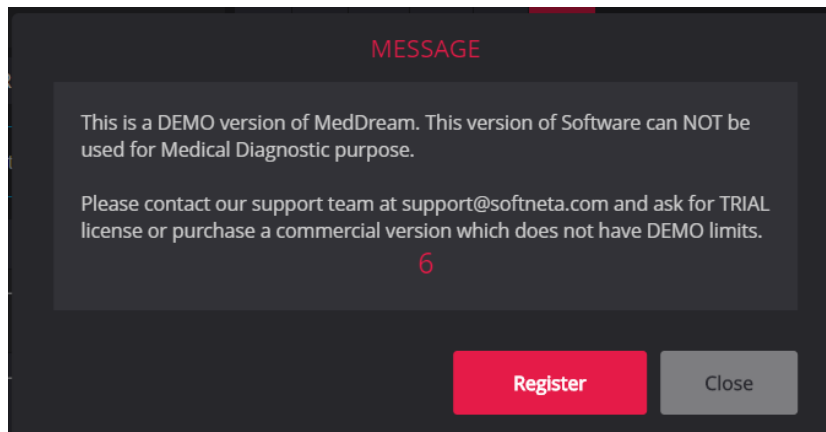

Figure 342. Demo version notification

- By click the **Register** button in About window (see description in section "About").

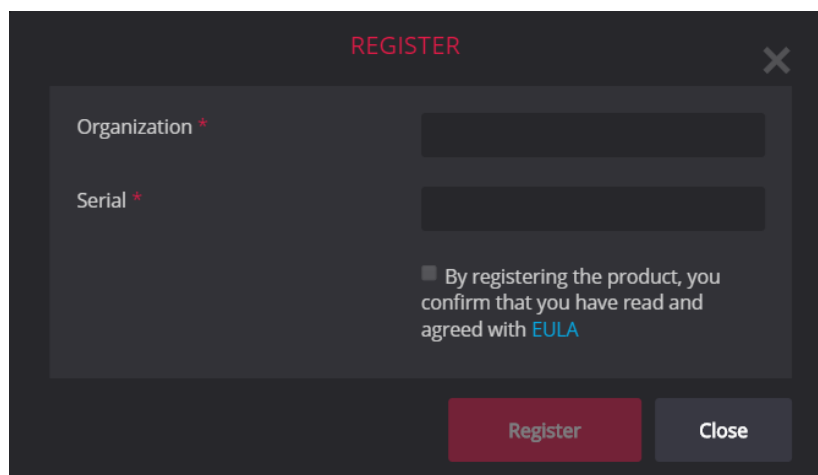

Figure 343. Registration window, if EULA is not read

You should enter the organization and license number that you were given by system administrator or system provider in license registration window. To start registration, you should read the end user license agreement. Click EULA link to open and read the end user license agreement, and check the confirmation box after the reading - the **Register** button is activated:

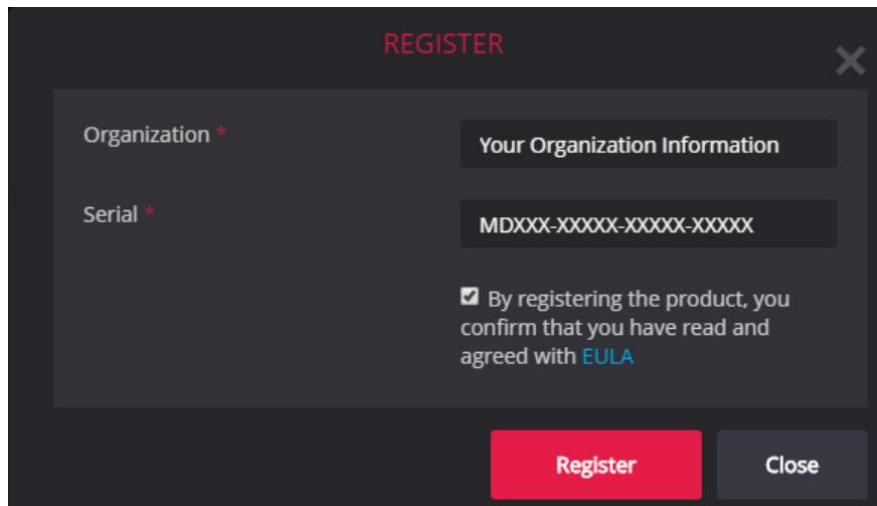



Figure 344. Registration window – registration activated

After the **Register** button is clicked, the system connects to the license server, verifies the entered license data, and registers the license. You can view the registered license data in About window.

 **NOTE!** The internet connection and access to license server should be ensured for successful license registration.

 **NOTE!** The system automatically renews the license, if license update is purchased and data is renewed in license server.

Settings

System settings allow you to customize the appearance and functionality of the system according to the user's needs. To change your MedDream settings, select **Settings** from the system drop-down menu. The **Settings** menu is displayed for the user, that either has right to modify his settings, or has administrator right.

NOTE! Note that the user with the administrator right can modify only the global settings or global hanging protocols, which, after saving, are shared by all users. See the install manual how to configure the settings per user group or user manually.

NOTE! To modify particular user settings, the user should have the right to modify user settings or hanging protocols, do not have the administrator right, and should be logged in with his login name.

You can do the following using the buttons in the top right corner of the search window:

- **Language** menu enables language change by picking language code in expandable list.
- Clicking **Notifications** button opens the notification window. The notifications functionality is explained in the section "Displaying notifications".

System settings are grouped by system windows and / or functions. Each set of settings is in a separate tab, which is opened by clicking on the tab name.

If the tab content does not fit to the window, the scrollbar is displayed. You can scroll the page with the scrollbar, or with the mouse wheel while hovering over scrollable tab content.

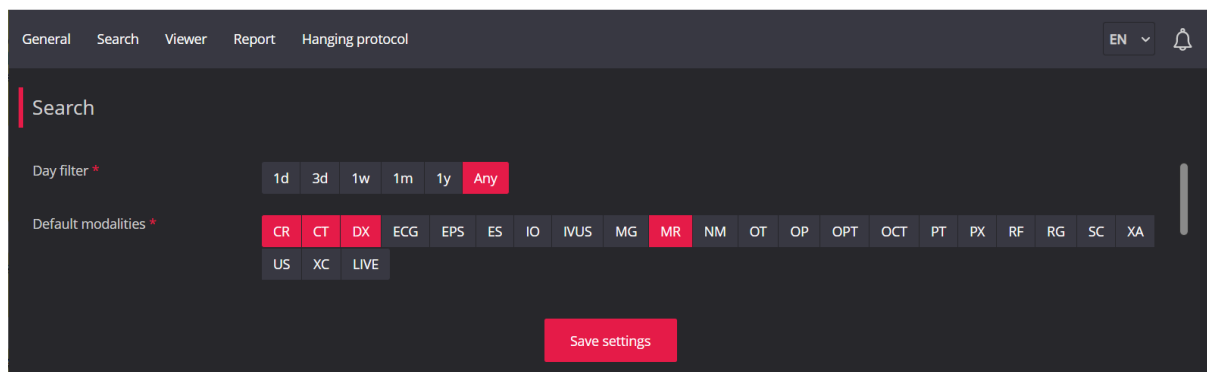

Figure 345. Settings window

The **Save settings** button at the bottom of each tab saves the settings' values into the settings storage. The saved settings are applied after the system restart.

NOTE! You will lose the changes that you've made if you exit the tab or close the settings window without clicking Save Settings at the bottom of the tab.

NOTE! If the user settings are saved at least once, the global settings are no longer used for this user. Contact your system administrator, if you need the user settings to be removed and return to the global settings.

NOTE! User settings and user hanging protocols are stored separately, so it is possible, for example, to save and use user's hanging protocols, but still have the global system settings.

NOTE! Note that user can change some of settings and these changes are saved in browser's local storage. If the browser's local storage contains setting values, the system used these values instead of settings file. To use the settings file, you should clean the browser's local storage on user machine.

A detailed description of each tab is provided in the subsections of this section.

General settings

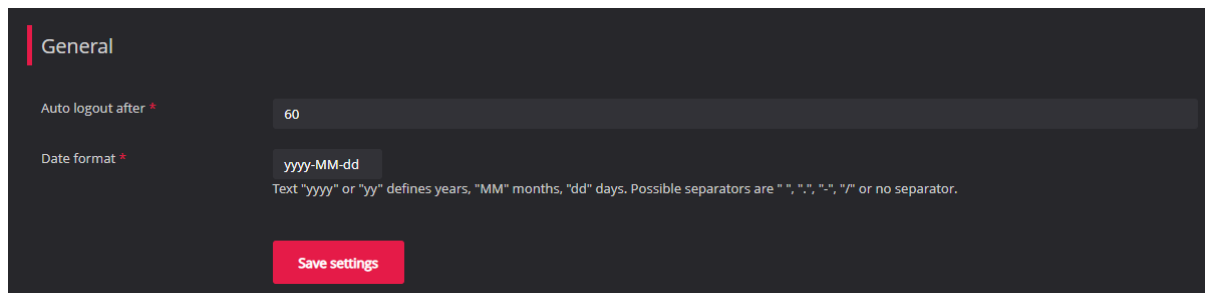

Figure 346. Settings window: general settings

On **General** tab you can modify the following settings:

- **Auto logout after** – you can enter the time frame in minutes when the system will logout automatically in case you forget to logout and close the system window. The default value is 60 minutes.
- **Date format** – you can specify the date display format. The default value is yyyy-mm-dd.

Search window settings

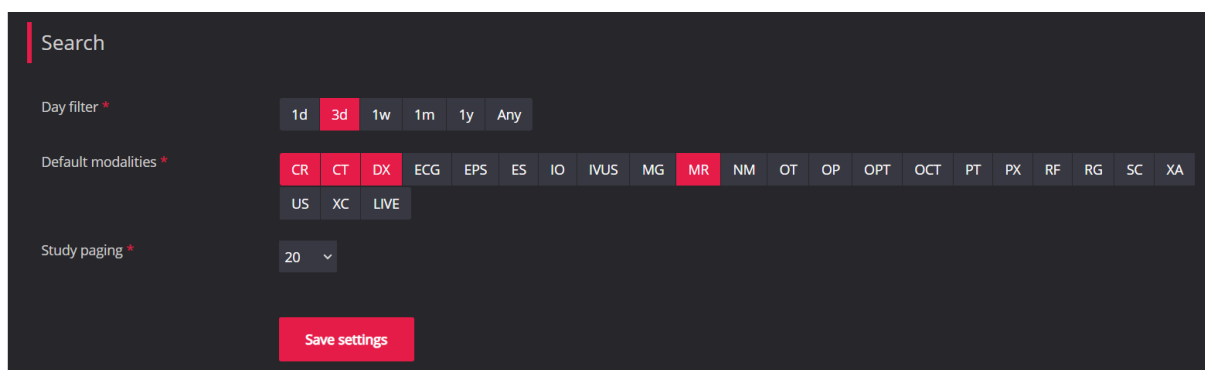

Figure 347. Settings window: search setting

On **Search** tab you can modify the following settings:

- **Day Filter** – you can create day filter that will be applied by default when Search window opens. The filter options are: **any, 1d, 3d, 1w, 1m, 1y**. The default day filter is **3d**.

NOTE! This filter is for compatibility with some PACSes (in MedDream "DICOM" PACS integration mode) that require a date range in all queries. It can also be used in direct integration modes if the database is too slow and accidental activation of the "Any" date choice results in unexpectedly long response times that disrupt the ordinary workflow.

- **Default modalities** – you can select modalities which buttons will be shown on the main search window for quick access. Click the modality button and it is highlighted. To change the selections status, click the modality button once more. The default selection is: CR; CT; DX; MR.

NOTE! The user can change the default modalities in Search window. The changes are saved in browser's local storage and will be applied when the user opens the Search window in the same browser.

NOTE! The default modalities setting is not applicable in mobile mode. In hist all modalities are displayed in Search criteria window and this list cannot be configured.

- **Study paging** – this setting allows you to set the number of studies shown on the page of the main search window. Select the studies per page that you wish to be shown as a default setting from the drop-down list values: 10, 20, 30, 40, 50, 100. The default value is 20 records per page.

Viewer window settings

In **Viewer tab** you can edit general Viewer settings, info label settings, toolbar settings and custom windowing settings.

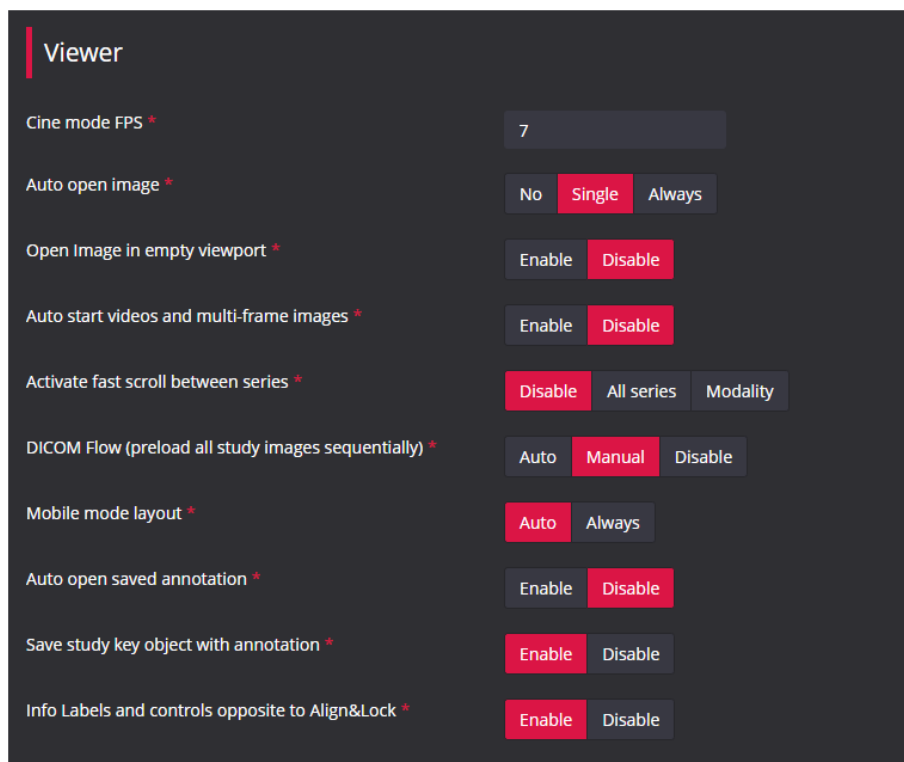

Figure 348. Settings window: general Viewer window settings

In Viewer tab of the Settings window, you can change the following Viewer settings:

- **Cine mode FPS** – number of frames per second when playing multi-frame images. The default value is 7 fps.
- **AutoOpen Image** – automatically opens the first image of the first series in the first viewport according to your choices:

No	The image does not open automatically when the study is opened in Viewer.
Single	The image is opened automatically only if the study consists of one image.

Always The image is always opened automatically.

– The default selection is **Single**.

 **NOTE!** Automatic image opening is applied only if opening study in new Viewer window and in desktop mode.

- **Open image in an empty viewport** - if option is enabled, right mouse button click on the image in thumbnail bar is activated, which opens the image in an empty viewport. The default selection is **Disabled**.
- **Autostart videos and multi-frame images** - automatically start playing multi-frame images, if enabled. The default selection is **Disabled**.
- **Activate fast scroll between series** – if option is enabled, the fast scroll function scrolls throughout all the series of the study, that is the first image of the next series is opened when the end of the current series is reached. The default selection is **Disabled**.
- **Activate fast scroll between series** – if **All series** or **Modality** option is selected, the fast scroll function scrolls throughout all the series of the study, or the series of a particular modality, that is the first image of the next series is opened when the end of the current series is reached. The default selection is **Disabled**. If **Modality** option is selected, the modalities list is displayed, and modalities should be selected by clicking and highlighting the desired modalities:

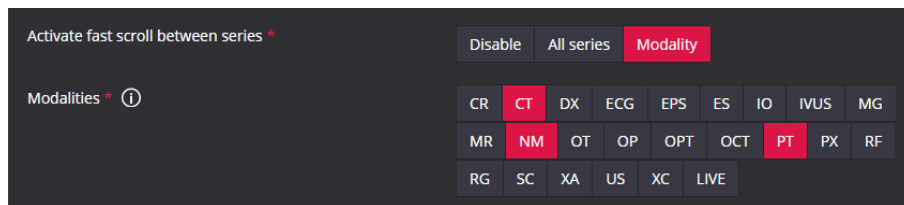



Figure 349. Settings window: modalities selection for Activate fast scroll between series setting

 **NOTE!** The user can activate or deactivate the fast scroll between series in Viewer window, and the scroll will be allowed even if **Activate fast scroll between series** is set to **Disabled**. Hide the Scroll button option “Activate the first scroll between series” in toolbar properties, if you do not want the user to be able to activate the scroll between series.

- **DICOM flow (preload all study images sequentially)** – preload all images in advance. If the **Auto** option is selected, the system automatically starts loading all the images on study open, and scrolling through adjacent images takes very little time, but the entire study must fit into browser’s memory. The default selection is **Manual.**, what means that series or whole study images if the user clicks preload button. If the **Disable** option is selected, the system performs progressive image preload around the viewed image, but manual preload of the series or the whole study images is also possible.
- **Mobile mode layout** forces mobile view used in desktop mode. The **Auto** options applies the mobile layout if working in mobile mode. The software automatically switches to mobile mode, if detects the mobile device on startup or desktop window resolution is resized to less than 992 pixels. If you need the Viewer’s window mobile layout in desktop mode, use **Always** option. The default selection is **Auto**.
- **Auto open saved annotation** – if option is enabled, the last saved annotation is automatically selected and displayed, when opening the image. The default selection is **Disabled**.

 **NOTE!** See installation documentation for configuring to not auto open the annotations, that were generated and saved by the algorithms.

- **Save study key object with annotation** – if option is enabled, when a KO object is saved, the PR is also save and a linking reference is created; when a KO with a link to a PR is opened, the PR is also opened.

- **Info Labels and controls opposite to Align&Lock** - activating this functionality, when 'Align&Lock' is activated in the viewport, all labels are displayed on the opposite side to the alignment; activating this functionality allows the specification of labels that must be displayed (see under "**Mandatory visible labels for Align&Lock**").

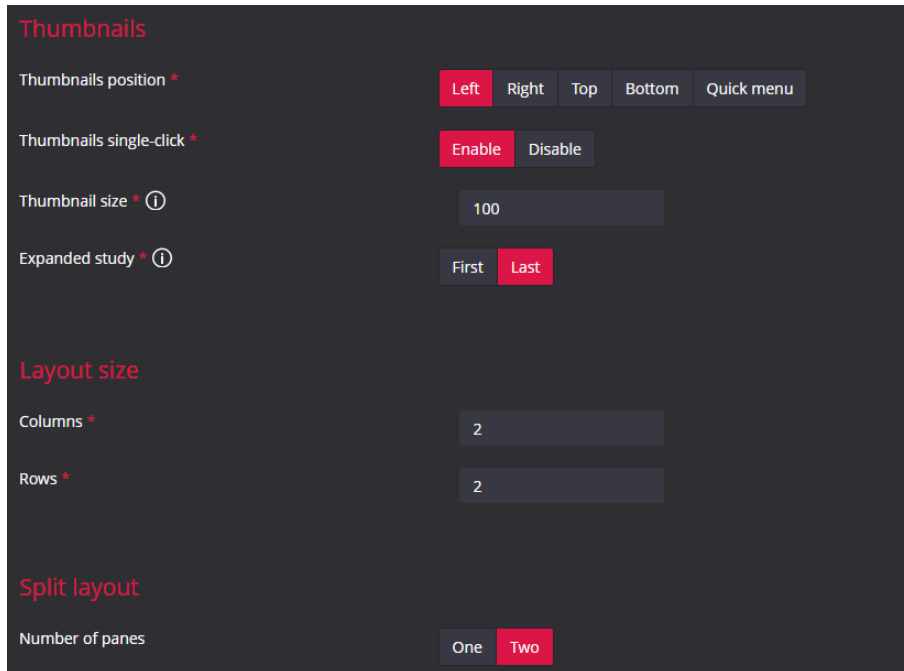

Figure 350. Settings window: Viewer thumbnails and layout window settings

The **Thumbnails** section of Viewer tab of the Settings window, you can change the following settings:

- **Thumbnails position** – allows to modify position of thumbnails with five possible options: Left, Right, Top, Bottom, Quick menu. The default selection is **Left**.
- **Thumbnails Single-Click** - once the option is enabled, a single click on an image icon will open the image (otherwise a double click is required). The default selection is **Enable**.
- **Thumbnail size** - indicates the size of the thumbnail image from minimum size equal to 50px to maximum size equal to 150px. The default value is 50 px.
- **Expanded study** - indicates which study, the first or the last, is expanded by default, when multiple studies are opened at once in the empty Viewer window. The default selection is **Last**.

The **Layout Size** indicates the number of viewports in the Viewer window:

- **Columns** - indicates the layout's number of columns. The values from 1 to 8 are allowed. The default value is 2.
- **Rows** - indicates the layout's number of rows. The values from 1 to 4 are allowed. The default value is 1.



NOTE! The user can change the layout size in Viewer window. The changes are saved in browser's local storage and will be applied when the user opens the Viewer window in the same browser next time.

- **Split layout. Number of panels** - specifies into how many parts - **one or two** - the viewport is split; this setting is used to construct the different functionality of the image enlargement on a mouse double-click.

Measurements settings

In the Settings window, in the Viewer tab, the **Measurements** group allows users to configure measurements:

- to change the colors and thicknesses of the measurements,
- and, separately, to change the colors and thicknesses of the pencil measurements,
- to change the modalities for the ruler to be displayed.

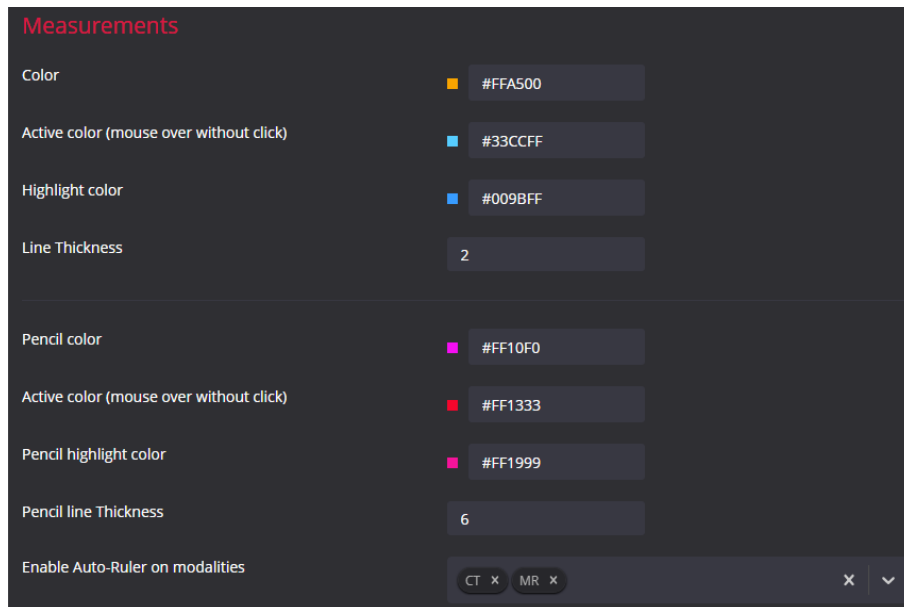

Figure 351. Settings window: measurements' settings

There are three colors:

- "Color" - which is used to represent the measurement when an action is performed;
- "Active color - the color that highlights the measurement when the mouse cursor hovers over the measurement but the left mouse button is not pressed and editing is not activated;
- "Highlight color" is used to highlight the measurement when editing mode is activated.

Enable Auto-Ruler on modalities setting shows the list of modalities, for which the ruler is displayed, if enabled by the user. By default, the "CT" and "MR" modalities are in the list. Select the modalities from the expandable list, or enter the modality directly at the end of the list to show the ruler for this modality. Click the icon "x" near the modality to delete it from the list.

Label Properties

Info Label properties

The **Info Label properties** section of Viewer tab in Settings window is used to indicate DICOM tags containing the information that should be displayed over the image, and configure another label related functionality.

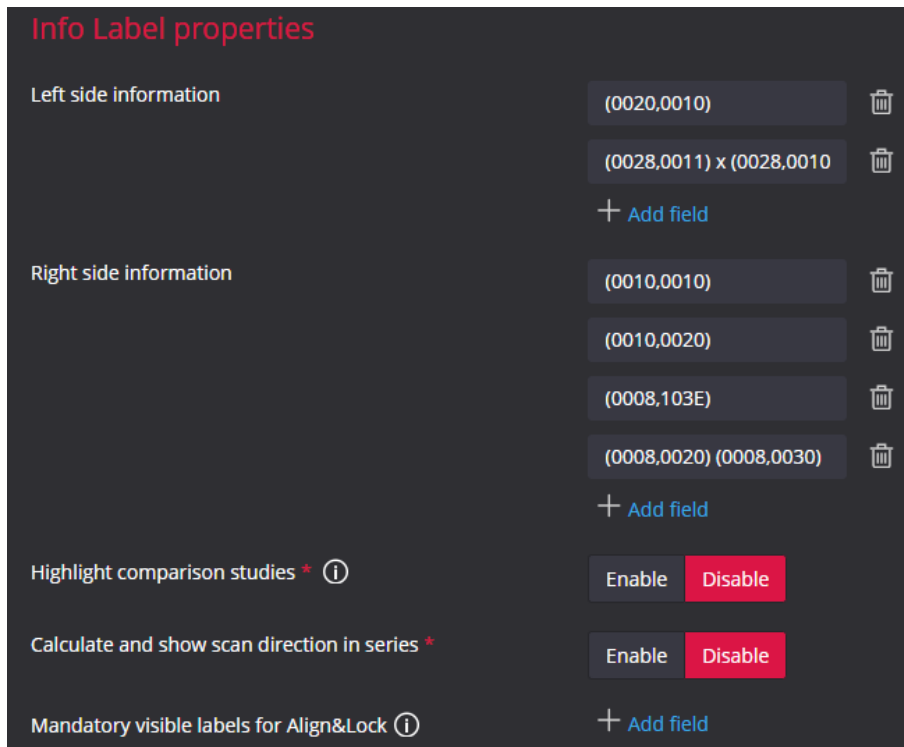

Figure 352. Setting window: Info Label properties in Viewer tab

Info labels on image

Left side information and **Right side information** settings describe the info labels displayed on image. In order to add new info label:

- Select the label place (**Left Side Information** or **Right Side Information**) and click **Add Field** in the appropriate section. The system shows the entry field:

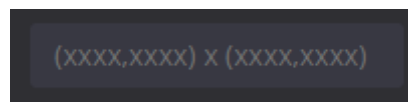

Figure 353. Info Label entry field

- Enter the label. The DICOM tag should be enclosed in parentheses using format (xxxx,xxxx). Label example: Patient position (0018,5100): (0020,1040).
- Save settings.



NOTE! Only first level DICOM tags may be used in labels.

After restart the system loads the new settings and shows the label on the image:

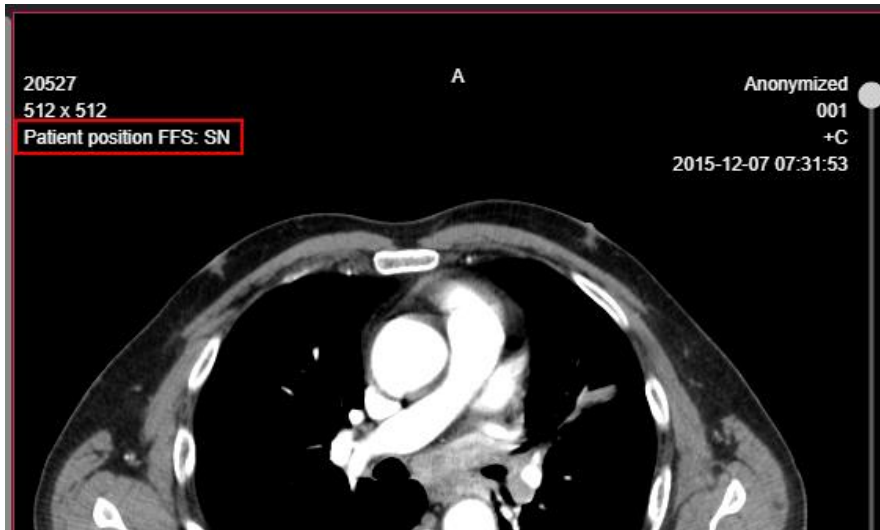

Figure 354. Showing Info Label on image

The default info labels are (see labels' view in the picture above):

- Left Side Information
 - (0020,0010) Study ID
 - (0028,0011) x (0028,0010) Image size in pixels Columns x Rows
- Right Side Information
 - (0010,0010) Patient's name
 - (0010,0020) Patient's ID
 - (0008,103E) Series Description
 - (0008,0020) (0008,0030) Study date Study time

To remove the label:

- . click **Remove** on the right side of the label entry field,
- confirm the action,
- save settings

Calculate and show scan direction in series setting enables calculation and display of the Series scan direction and slice distance (position) in scan axis. The default value is **Disable**. Note, that the calculations require additional data and may cause the delay in image display.

Highlight comparison studies

The **Highlight comparison studies** setting allows to distinguish more easily the first opened study from all other studies, that are opened in the Viewer window for comparison. By default, the **Highlight comparison studies** option is disabled. If **Highlight comparison studies** option is enabled, the study date is highlighted in the thumbnail bar, and the last Right side information label is highlighted in the viewport for comparison study instance. You can select other Right side information label for highlighting by clicking the **Select comparison label**.

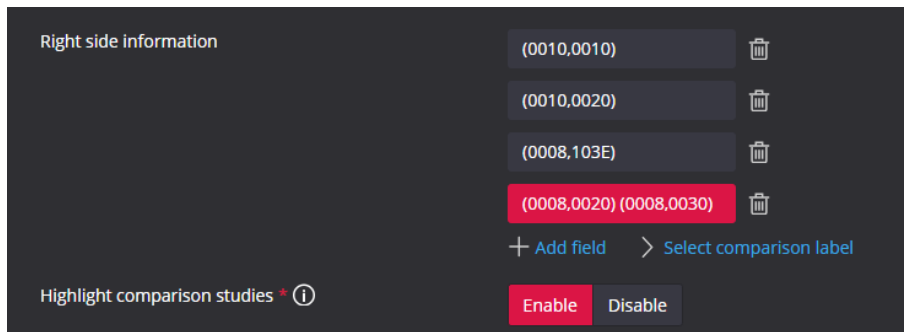

Figure 355. Setting window: Highlight comparison studies settings

Mandatory visible labels for Align&Lock

The setting **Mandatory visible labels for Align&Lock** allows user to add labels that will remain visible even when the height of the viewport is reduced to the size where all the labels cannot fit. The setting is only valid if "Align&Lock" is enabled and the setting **Info Labels and controls opposite to Align&Lock** is activated.

Custom study label properties

The **Custom study label properties** section of Viewer tab in Settings window is used to configure additional label in study header section of thumbnail bar. By default, the **Enable custom study label** option is **Disabled**. If **Enable custom study label** option is enabled, the additional label is inserted between the patient's name and study date in thumbnail bar. The label value may be selected from the **Value for custom study label** drop down list. The "none" value inserts the empty row, which may be filled with custom data by integrating system.

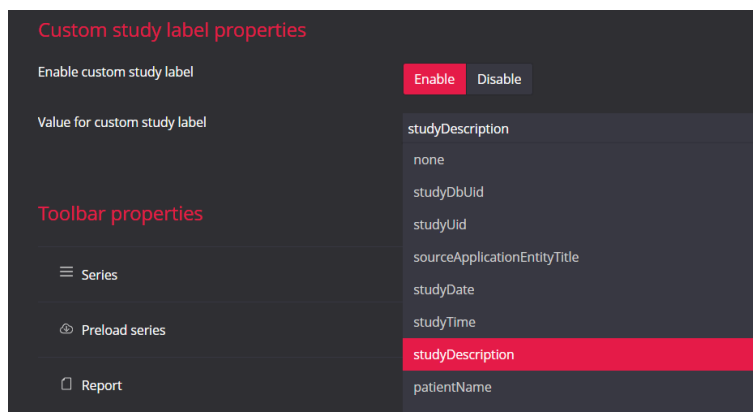

Figure 356. Setting window: Custom study label properties

Presenter Settings

In the Settings window, in the Viewer tab, the **Presenter Settings** group allows users to configure:

- Line Thickness;
- Fade Out Time (in seconds);
- Values of the 5 colors visible in the tool menu.

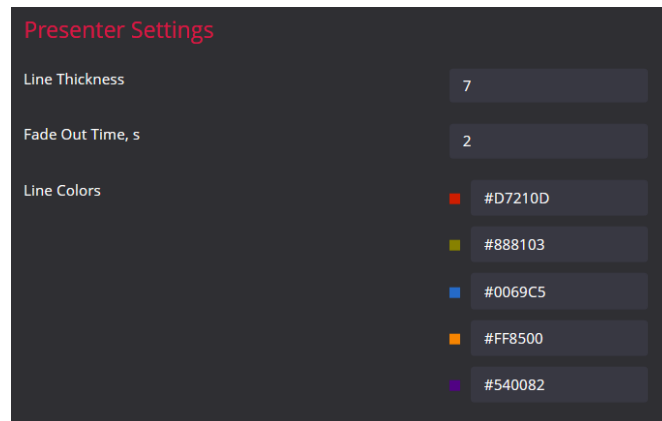

Figure 357. Settings window. Presenter settings

Toolbar Properties

In the **Toolbar properties** section of Viewer tab in Settings window you can customize the Viewer toolbar's tools and the order in which they are displayed.

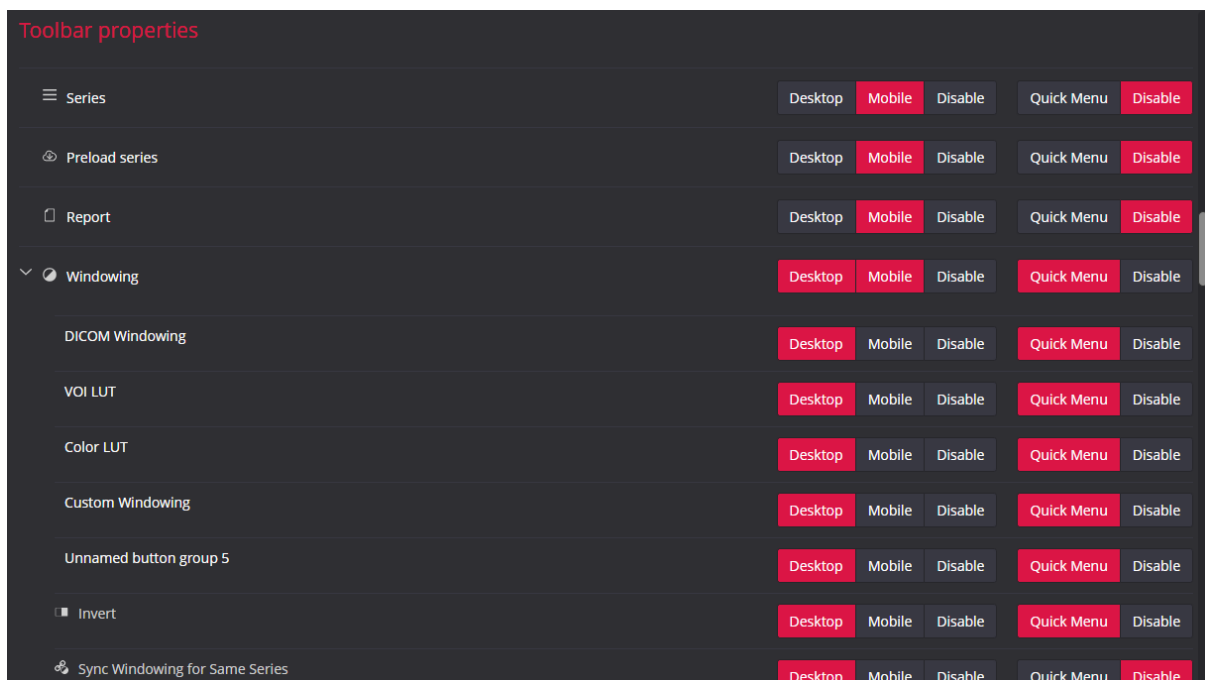

Figure 358. Setting window: Toolbar properties in Viewer tab

Use toolbar properties for:

- Changing the order of toolbar's tools.
- Showing or hiding the tool.
- Customizing the quick menu.

To change the place of tool (or tools group) in toolbar, press the right mouse button on the tool and drag the tool on top of the desired place (line). After releasing the mouse button, the tool will be inserted above the line.

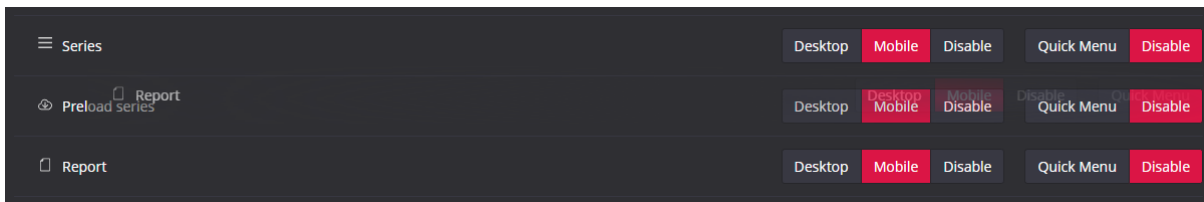

Figure 359. Changing the tool's position in toolbar

NOTE! You can change the tool (or tools group) place in toolbar. You cannot change the item place in tool group (tool's expandable menu).

To customize the toolbar view for different modes, select one or more modes for which the tool should be shown in toolbar – the selected mode is highlighted:

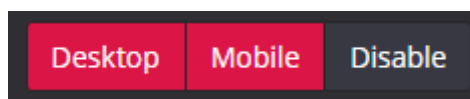

Figure 360. Selecting the tool's showing mode

- **Desktop** – the tool is shown in toolbar only if working in desktop mode.
- **Mobile** – the tool is shown in toolbar only if working in mobile mode.
- **Disable** – the tool is never shown in toolbar.

NOTE! If working in desktop mode with mobile layout (Mobile mode layout set to Always), the desktop toolbar is used.

NOTE! You can change the display mode selection for all levels: the toolbar's tool, options group and menu option in tool's expandable menu. Verify the visibility of higher hierarchy items (like tool's group, or tool's) when changing the item's visibility mode: the option in expandable menu is displayed only if the tool group and tool are visible in the selected mode.



To include the item in quick menu, use the quick menu customization settings. **Quick menu** selection adds the item in quick menu, and **Disable** selection removes it from quick menu. You can include in quick menu the following:

- the menu option from expandable tool's menu, for example the **Line** option from **Measure** tool's menu;
- the group of generated menu options – all the generated menu options will be included in quick menu. For example, the **DICOM Windowing** menu group from **Windowing** tool's menu.

NOTE! The system generates two-level quick menu, if you specify to include the tool itself (for example, **Measure**) in the quick menu in the settings. If the tool (for example, **Measure**) include in quick menu is disabled, and its menu option (for example, **Line**) include in quick menu is enabled in the settings, the **Line** option is included in first level quick menu.

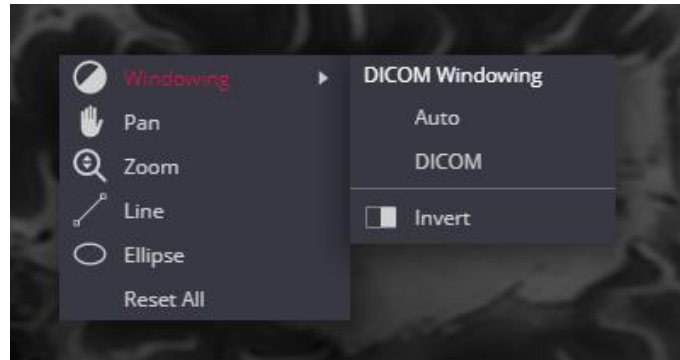

Figure 361. Quick menu: measurement in the first menu level by default

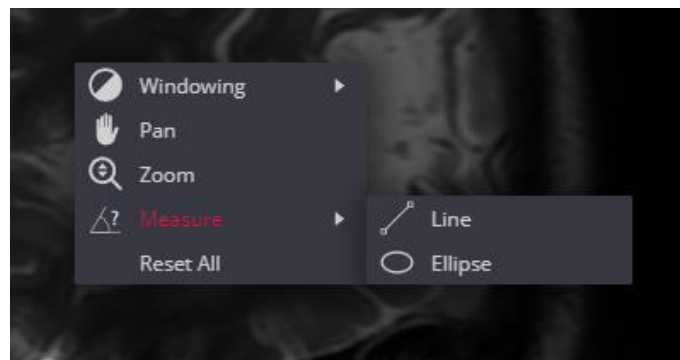

Figure 362. Quick menu: Measure tool included in quick menu and measure option moved to the second menu level

Windowing settings

The Windowing settings of Viewer tab in Settings window allows users to create a custom window level preset for a selected modality list. The custom windowing options will be shown in expandable **Windowing** menu under **Custom Windowing** group.



Figure 363. Custom windowing options: default values

The default settings after system deployment contain the following options for CT modality:

- **CT Abdomen** – a preset setting for abdomen studies.
- **CT Bone** – a preset setting for bone studies.
- **CT Brain** – a preset setting for cerebrum studies.
- **CT Liver** - a preset setting for the liver studies.
- **CT Lung** – a preset setting used for studying the images of the lungs.
- **CT Mediastinum** - a preset setting for mediastinum studies.
- **CT Pelvis** – a preset setting for pelvis studies.
- **CT Posterior Fossa** - a preset setting for Posterior Fossa studies.

The Edit, and Delete icons-buttons at the end of each windowing line provides access to windowing data review and edit.

To create custom windowing option:

- click **Add new**;
- enter values for the custom windowing option: **Label**, **Width**, and **Center**. Select modalities of your choice in order to assign the new window level function to certain modality (-ies). All four fields are mandatory:

The screenshot shows a 'CREATE WINDOWING' dialog box with the following fields and options:

- Label ***: Test
- Width ***: 5
- Center ***: 5
- Modalities ***: A grid of buttons for various modalities. The 'CT' button is highlighted in red.

CR	CT	DX	EKG	EPS	ES	IO	IVUS
MG	MR	NM	OT	OP	OPT	OCT	PT
PX	RF	RG	SC	XA	US	XC	LIVE

Buttons: Create, Close

Figure 364. Custom Windowing creation window

- once done that, click on **Create** button.

New predefined Windowing level will appear on the Windowing menu, if the modality of the active image corresponds to the custom windowing modalities. To apply the custom windowing, click its title in drop-down menu.

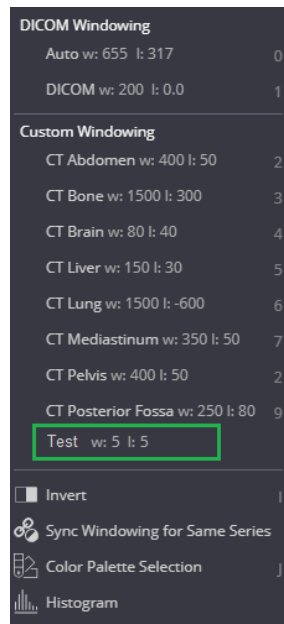

Figure 365. Custom windowing in the drop-down Windowing menu

You can remove the custom windowing by clicking the **Remove** button on the right of the record. You can **Edit** the custom windowing values, if desired.



NOTE! It is possible to change the order of the values. The same order in which the Windowing are sorted in the Settings window is used to sort the values in the Windowing menu item, and the same order is used to create the dynamic values for the shortcuts.

Report settings



Figure 366. Settings window: report settings

On **Report** tab you can modify the following settings:

- **Open in new window** – selecting the **Enable** option opens the study Report in a new browser tab. The default selection is **Disable** and the Report is opened in modal window.
- **Allow export to PDF** – selecting the **Disable** option eliminates the possibility to include the study report in study archive. The default selection is **Enable**, and in the Export window the user has possibility to select either include the report into study archive, or not include.

Hanging protocol settings

NOTE! The hanging protocols version v2 is available for usage. For details, contact to Softneta support at this email: support@softneta.com.

On **Hanging protocol** tab, you can create new hanging protocols, review and modify existing hanging protocols. The window below lists the hanging protocols, which are provided in default hanging protocols.

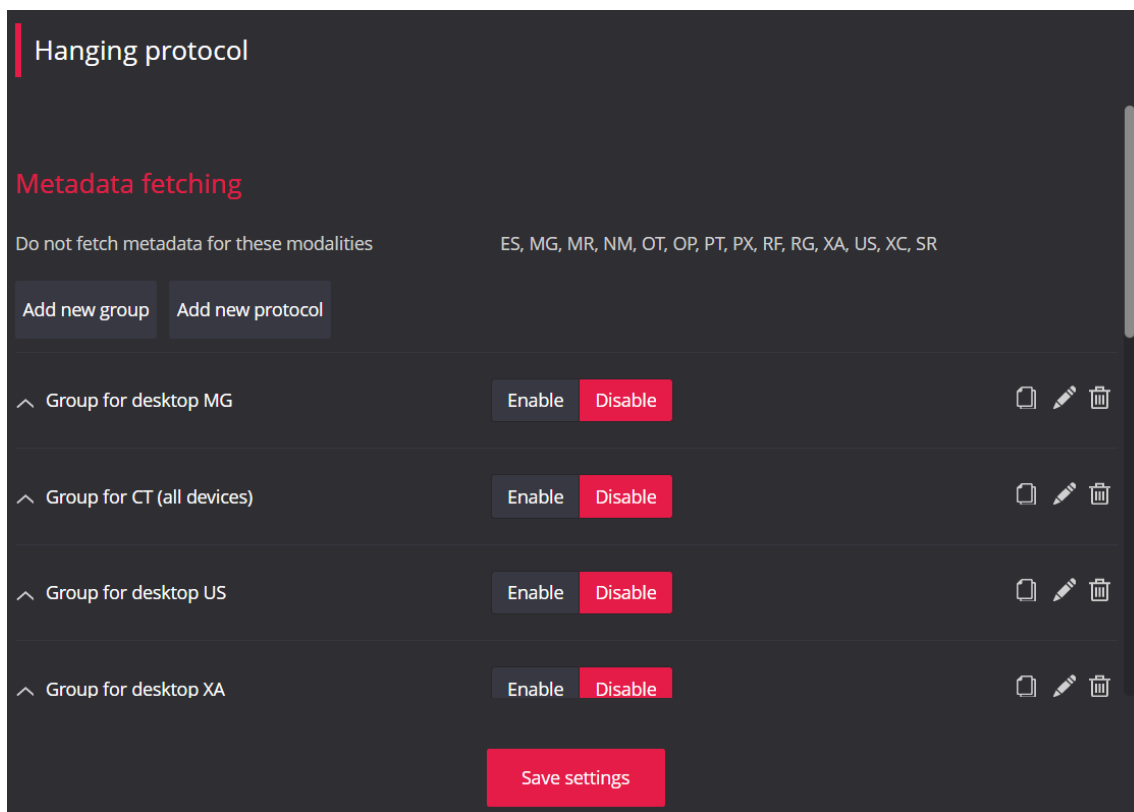

Figure 367. Hanging protocol settings

NOTE! All the data changes that are done in Hanging protocol list, group and protocol child windows (like create group window, create protocol window) are saved in the temporary storage. That means the changes are not accessible to the other users and would be lost in case of program accidental close. The permanent data saving is done only when the **Save settings** is done.

NOTE! The hanging protocols are stored separately from the other system settings.

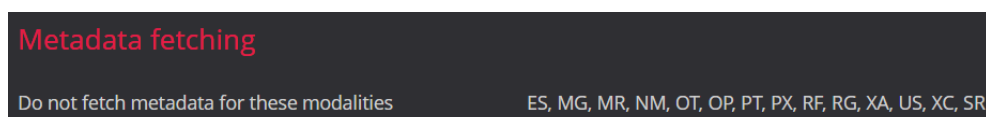

Figure 368. Modality filter for metadata fetching

By default, "Do not fetch metadata for these modalities" are set for modalities CT, ES, MR, NM, OT, OP, PT, PX, RF, RG, XA, US, XC, SR. If metadata is not used, only the conditions with following tags are executed:

- Special tags: series_count, instances_count, no.

- DICOM tags: (0008,0016) SOPClassUID, (0002,0010) TransferSyntaxUid, (0008,0060) Modality, (0010,0010) PatientName, (0008,1030) StudyDescription, (0008,103E) SeriesDescription.
- In conditions with DICOM tags (0020,0011) SeriesNumber and (0020,0013) InstanceNumber, the system correspondingly uses the series or image serial number, starting from 0, instead of the tag's value from DICOM file.

If the Hanging protocol includes conditions with tags other than those listed above, such conditions are ignored.

NOTE! In Hanging protocol, the setting **Do not fetch metadata for these modalities** can only be modified in settings file. Note that for large-scale studies (for example CT, MRI) it is recommended not to use metadata due to long loading time.

Clicking the **Add new group** button on Hanging protocol tab opens the **Create group** window:

Figure 369. Create hanging protocol group window

To create a new hanging protocol group:

- Enter the required group name in **Name** field. The group name is used for protocol identification and is shown to the users in MedDream viewer.
- If you need, enter the group description in **Description** field. The group description is only visible in settings.
- Select the **Devices** for which the group's protocols should be applied. Clicking the button with device name enables or disables selection.
- Specify the Group conditions.

Entering the Hanging protocol condition

Condition is an expression that could be evaluated as true or false and is used for automatic applying of Hanging Protocol. Condition consist of special tag or DICOM tag that is evaluated against static value according the specified 'operand. An example of condition: 'Modality equals to 'XA''. Several conditions are joined using AND operand, that means all conditions in the group should be met.

A **Tag**, **Operand** and **Value** fields for new condition entry is displayed if "+" icon near the **Add condition** field is clicked:

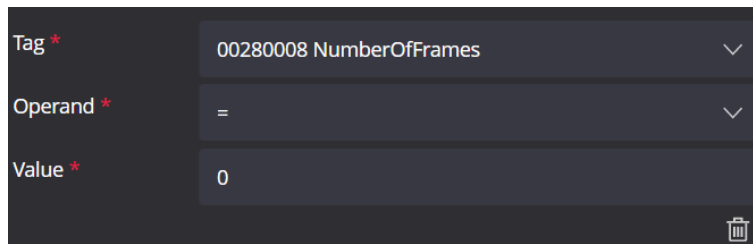

Figure 370. Hanging protocol condition's entry fields

To enter the condition:

- select DICOM or special tag in Tag drop-down list. In group conditions the special tags series_count (number of series in study) and instances_count (number of images in study) can be used;
- select the evaluation operand in Operand drop-down list. The operands list is automatically adjusted to the type of selected tag. The operands list for numeric tags: "=", ">", "<", ">=", "<=", "!=". The operands list for string tags: "match", "not_match", "begins_with", "end_with", "contain";
- enter the value in Value field. The string value should be entered for string tag, and the numeric value should be entered for numeric tag.



NOTE! If the user enters more than one condition with Modality tag and the identical operand in all the conditions, the protocol group is applied only for the studies having the series of all the requested modalities.

To remove the entered condition, click the **Remove** icon below the condition entry fields.

- Activate hanging protocol group by selecting Enable or Disable buttons in the **Active** field. The disabled groups and its protocols are not used for automatic or manual apply.
- Click the **Create** button when all the group data is entered. The **Create group** window is closed, the entered group data is saved in temporary storage and is shown at the end of hanging protocol list on Hanging protocol setting tab.

Clicking the **Add new protocol** button on Hanging protocol tab opens the **Create protocol** window:

Figure 371. Create protocol window

To create a new hanging protocol:

- Select the group of the hanging protocol in **Group** drop-down list.
- Enter the required protocol name in **Name** field. The protocol name is used for protocol identification and is shown to the users in MedDream viewer.
- If needed, enter the protocol description in **Description** field.
- Define the layout by entering the number of columns in **Layout columns** field and the number of rows in **Layout rows** field.
- Specify the **Study conditions**, that will be used to select whether the protocol should be applied to the study. See description of condition entering on page 239.
- Specify the image selection and display data for each view:

NOTE! The view is identified by number [row number]x[column number], that is identifier “1x2” indicates the view in the first row and second column. The arrow near the view indicator can be used to expand or collapse the data entry fields for the view.

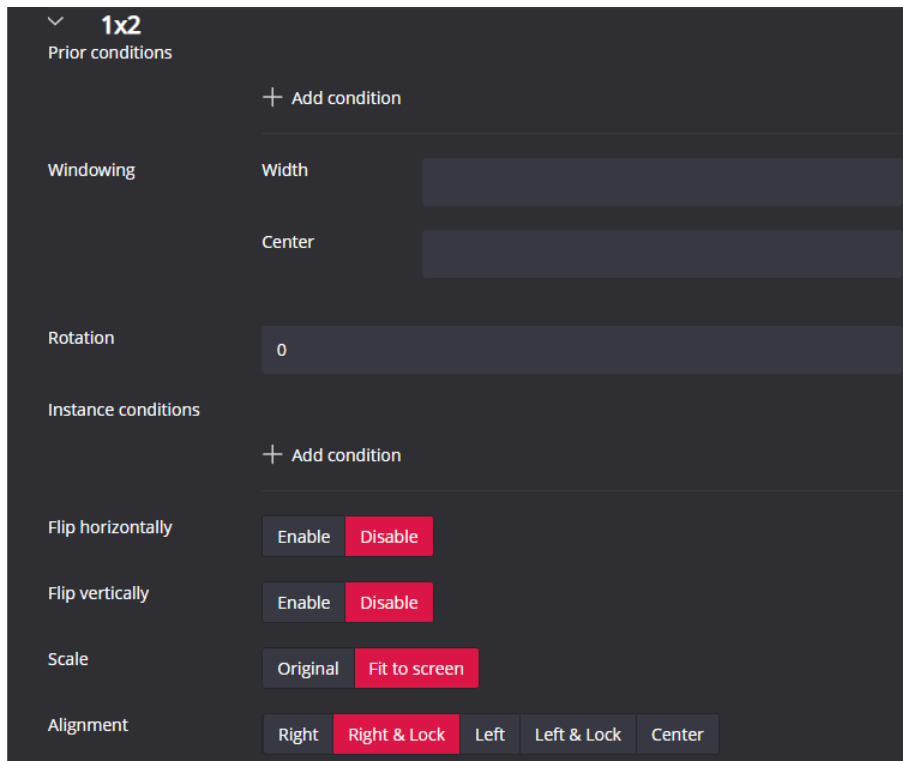

Figure 372. Entering View settings in hanging protocol

- specify the **Prior conditions** if you want the image from other study in patient history to be loaded in the view. The special tag **no** (the number of prior study from patient's history, starting from the most recent as "1") can be used. If **no** not specified, the most recent prior study that meets the other conditions is taken. See description of condition entering on page 239;
- specify the **Instance condition** for selecting the image from the study, that you are opening (or prior study, if prior study conditions are entered), to display in the view. See detail description of condition entering on page 239;
- enter the values for image display: windowing, rotation, scale, alignment.
- Click the **Create** button when all the protocol and views data is entered. The Create protocol window is closed, a new protocol is saved in temporary storage and is shown as the last protocol of selected group in protocols list on Hanging protocol setting tab.

The Hanging protocol list is two level expandable list with the hanging protocol group in the first level and the hanging protocols of the group in the second level.

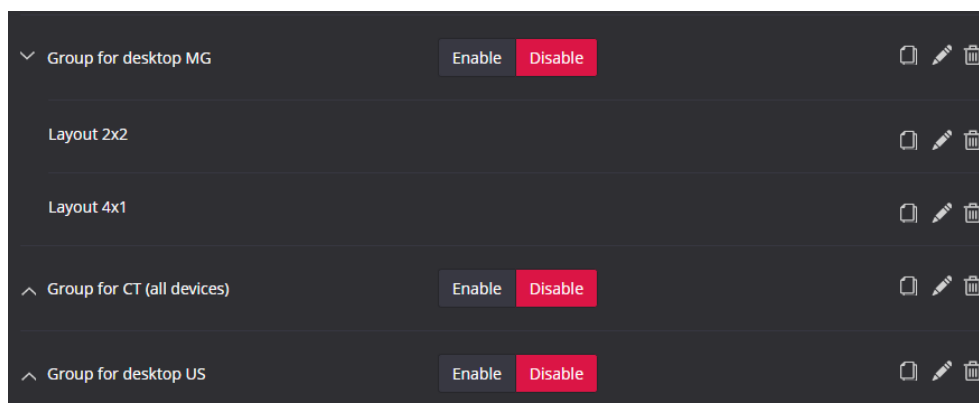

Figure 373. Hanging protocols list

You can perform the following in the hanging protocols list:

- To expands or collapse the list of group's protocols with chevron icon at the left of group's name.
- To enable the group's protocols by selecting the Enable/Disable buttons. The disabled groups and its protocols are not used for automatic or manual apply.
- The Copy, Edit, and Delete icons-buttons at the end of each group's and protocol's line provides access to group's or protocol's data review and edit:
 - clicking the **Copy** icon makes the copy of hanging protocol or group of protocols. The protocol is placed at the end of the group protocols list and postfix "-copy" is added to the name of the copied protocol. The group is placed at the at the end of the group list and postfix "-copy" is added to the name of the copied group and all its protocols;
 - Clicking the **Edit** icon at the end of group line opens the **Edit group** window with group data filled in the entry fields. You can review and edit the group's data. See detail fields description on page 239;
 - Clicking the **Edit** icon at the end of protocol line opens the **Edit protocol** window with protocol data filled in the entry fields. You can review and edit the protocol's data. See detail fields description on page 240;
 - Clicking the **Remove** icon at the end of group or protocol line deletes the item. If the group is removed, all the protocols of this group are also deleted.
- The drag-and-drop functionality for changing the order of group in the list and for changing the order of protocols in the group. To change the place of the group or protocol item, press the right mouse button on the item and drag the item to the desired place. The items order is important in automatic hanging protocol apply: the first group, that meets the group conditions, is chosen and the first protocol of this group, that meets the study conditions, is applied.

MedDream Mobile mode

You do not need a separate MedDream software version to use it on mobile devices. MedDream software automatically switches to mobile mode, if detects the mobile device on startup or desktop window resolution is resized to less than 992 pixels.



NOTE! Note, that browser's zoom function changes resolution and the software may automatically switch to mobile mode.

Features of MedDream mobile mode:

- Adjusted Search window layout;
- Adjusted Viewer window layout;
- Adjusted Settings window menu;
- Some functional limitations.

Further subsections describe Search window, Viewer window, and Settings window mobile layout and mobile mode functional limitations. For detail functionality and usage description see "Minimum hardware requirements for client-side MedDream viewing functions", "Displaying notifications", "MedDream DICOM Viewer", and "Settings" sections of this manual.

Search of studies in mobile mode

Search for studies mobile layout consist of two windows:

- Search criteria window;
- Search results window.

If successfully logged in, the **Search criteria** window opens:

Figure 374. Search criteria window in mobile mode

The following search criteria are supported in mobile mode:

- **ID** – patient's ID,
- **Name** - patient's name and/or surname,
- **Description** –study description,
- **Date Time** - date interval, selected in pick list,
- **Modality** – modalities selected in pick list,
- **Storage** – the PACS or other configured storage, selected in drop-down list.

See the detail description of search criteria in section “Displaying notifications”.



NOTE! The mobile mode has the following search limitations comparing to desktop version:

- search according accession number and source AE title is not allowed;
- search according custom date interval is not allowed;
- the customization of modalities pick list and search according custom modality is not allowed.

To find the study, enter **search criteria** and press the **Search** button. System displays the studies list in the **Search results** window:

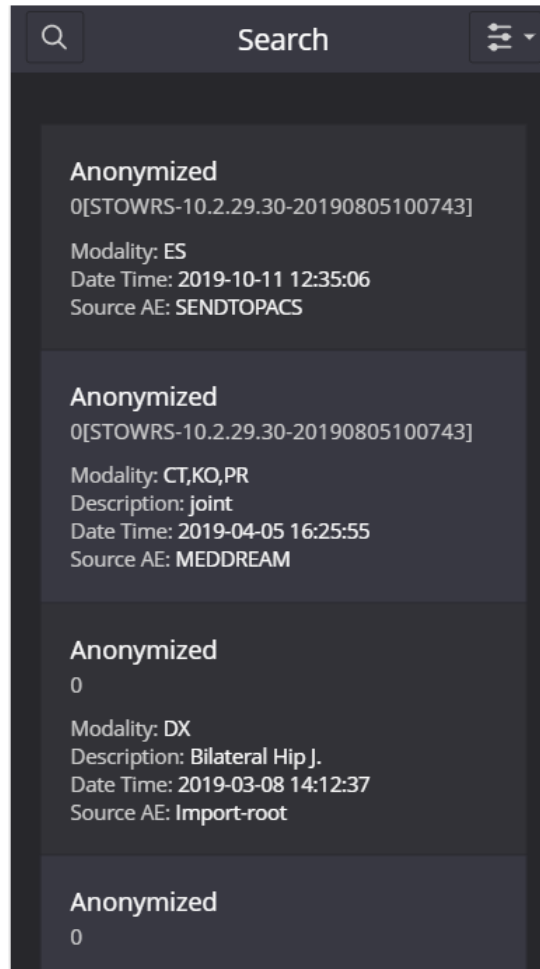

Figure 375. Search results window in mobile mode

The results list displays the following study information:

- Patient's name and surname in the first line.
- Patient's ID number in next line.
- **Modality** – field shows method which was used to obtain the study images (modality).
- **Description** – field shows study description
- **Date Time** – field shows study date and time
- **Source AE** – field shows title of the device from where the study was sent to the PACS.



NOTE! The field is empty if the DICOM file or PACS does not have the particular data.

In the search results window, you can do the following:

1. To navigate through the result list, use the scroll bar or drag up and down with one finger (or fingers) on the result list. The number of currently loaded studies and total number of search results are displayed at the bottom of the list:

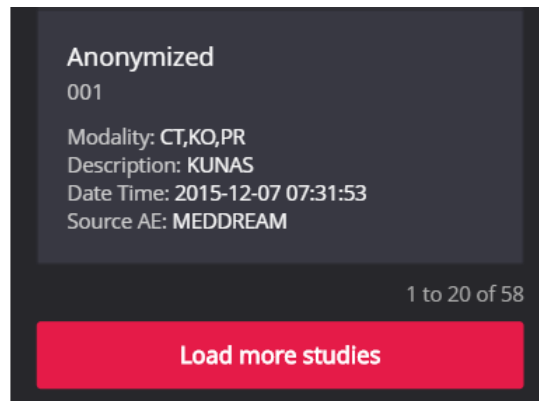





Figure 376. Page navigation in the search results in mobile mode

2. To load more studies, press **Load more studies** button – next page is loaded.

 **NOTE!** The number of studies per page is defined in system settings.

 **NOTE!** The **Load more studies** button is not displayed if all the studies are loaded.

3. To open the study in viewer, press at any place of study description. The selected study opens in Viewer (see [Opening studies in MedDream Mobile mode](#) section for detail description).

4. To return to the Search criteria window, press the search button  at the top left corner of the search results window.

The description of the other buttons in the **Search criteria** window and **Search results** window:

1. To change the language, press the **Language** button  at the top left corner of the **Search criteria** window and press the language option in drop-down menu.

2. **System** menu  at the top left corner of the **Search criteria** window and **Search results** enables access detailed system information and functionality description (see [System menu functions](#) section for detail description).

 **NOTE!** Systems menu options may be disabled in Settings. The Settings options may also be not allowed by user rights.

 **NOTE!** The Forward and Export functions in search results list are not available in mobile mode.

Viewer window in mobile mode

The Viewer window mobile layout contains the following zones:

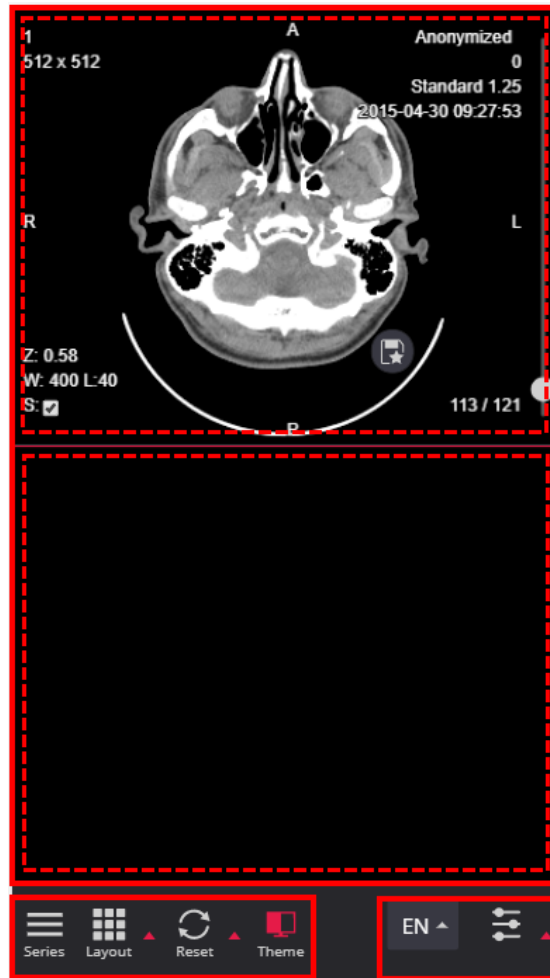

Figure 377. Viewer window zones in mobile mode

1. Image manipulation tools zone is shown at the bottom left side of the window. What buttons and in what order are shown in toolbar is described in system settings (see section Toolbar Properties).

NOTE! The tools set may vary depending on content of the active viewport.

If there is not enough space for all toolbar buttons, the toolbar is extended and horizontal scrollbar is displayed under the toolbar:

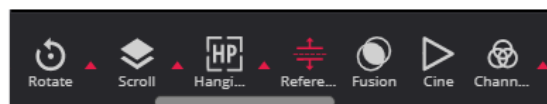



Figure 378. Toolbar's scrollbar in mobile mode.

Drag the toolbar to get the required tools.



In toolbar you can activate tool usage, if the tool can be operated on the touch screen. To activate the tool, follow these steps:

- Press on the icon of inactive tool



- The tool is activated and tool icon is highlighted . In the example, the activated Windowing tool can be used on the touch screen: dragging upwards or downwards changes Level values, and dragging right or left changes Window values.

The tool activation is deleted by pressing the tool icon once more or by activating another tool.

 **NOTE!** Mobile mode does not support middle and right mouse button actions and only the tool, that is associated with the left mouse button (indicated by mouse icon ) , is activated.

For a description of image manipulation tools in mobile mode, see the section Manipulating images in MedDream Mobile .

Press the triangle on the left of tool icon or long press tool icon to open the modal with tool's menu:



Figure 379. Tool's menu in Viewer window in mobile mode

You can activate the menu option by pressing it. If the option has an assigned shortcut, the key combination is written on the right: pressing 'SHIFT' and 'T' keys aligns the active image left.

2. The system tools zone at the bottom right corner of the window contains language selection button and system menu button, that function identically as in desktop mode (see description on page 18).

3. The view zone takes the largest part of the Viewer window and is designated to view and analyze the images. The view zone may be divided to several sections, each section (dashed line in figure) working as separate viewport for image viewing. The manipulation is allowed in one active viewport at a time. To activate the viewport, press on the viewport area – the active viewport is highlighted. The image manipulation toolbar is automatically adjusted according the content of the active viewport.

At the right side of the viewport the scroll bar with the scroll cursor, that is scrolled respectively to the position of the active image in the series, is shown. At the bottom of the scroll bar is the total number of images in the series and the number of the active image. Dragging the cursor along the scroll bar or pressing on the desired scroll bar position changes the image.

 **NOTE!** Viewer window mobile layout does not support thumbnail. To open the image use toolbar's button **Series** (see description in section "Series"). To preload the series images, use toolbar's button **Preload Series** (see description in section "Preload Series").

 **NOTE!** The quick menu is not supported in mobile mode.

Opening studies in MedDream Mobile mode

 **NOTE!** See section "Patient studies list in mobile mode" for detail description how to open the studies from the Patient studies list.

To open the study from MedDream Search window, please do the following:

1. Find the required study in Search results window and press on the study description area:

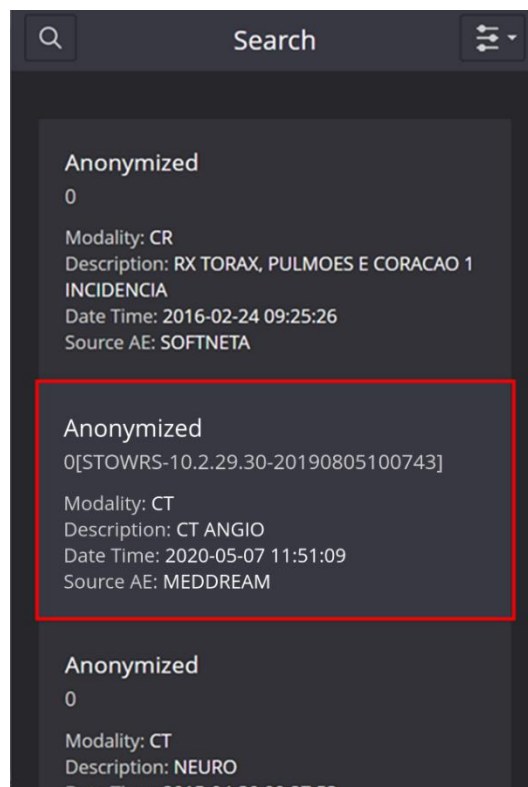

Figure 380. Study description area in Search results window in mobile mode

2. A new browser tab with a Viewer window will pop up and the Study window automatically opens in it:

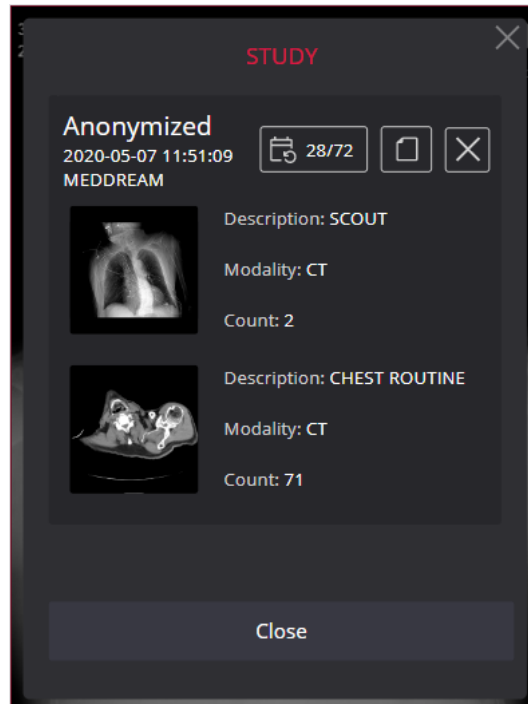

Figure 381. Selecting the study image in mobile mode

NOTE! The first image automatically opens, if the first image opening conditions are met (see description in [Settings](#)).

NOTE! The progress bar appears at the top of the window if the study preload process is ongoing.

3. Find and press the image in the Study window (see detail description in section “Series”) to open it in Viewer. Or close the Study window by pressing **Close** button to the first study image, that was opened in background.



Figure 382. Viewing selected image in mobile mode

4. If you need to open more than one study (e.g. to compare the images from different studies) in the same Viewer window, please do the following:

- Change the Viewer window layout (see description in section “Layout and Multi image”) and press on the viewport in which you want to open other study. The viewport is activated:



Figure 383. 2x1 Screen layout with active bottom viewport in Viewer window mobile mode

- Go back to the search results window by pressing MedDream search browser’s tab.
- Find and select the study in search results, as described in step 1.
- The program navigates to MedDream viewer browser’s tab and pop-ups the Study window. The Study window contains all the studies that were opened in Viewer’s window. The progress bar appears at the top of the window if the study preload process is ongoing. The selected study is displayed in the first position of studies list:

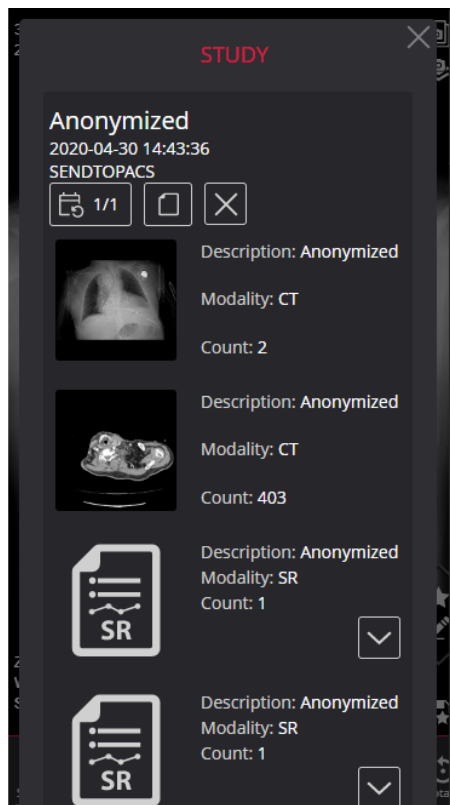

Figure 384. New study added at the top of the studies list of the viewer window

NOTE! Use Series button to open the Study window and select the other image from the studies that are already opened in Viewer's window.

NOTE! Use patient history button in Study window to open the study from patient historical studies list.

- Find and press the image thumbnail to open it in an active viewport:



Figure 385. Multiple images opened in mobile mode

Patient studies list in mobile mode

The **Patient studies list** may be viewed in Patient studies window, and Patient history window. See sections "Patient studies window" and "Patient history" for detail conditions when and how these windows may be opened.

In mobile mode the list view is used for patient studies list:

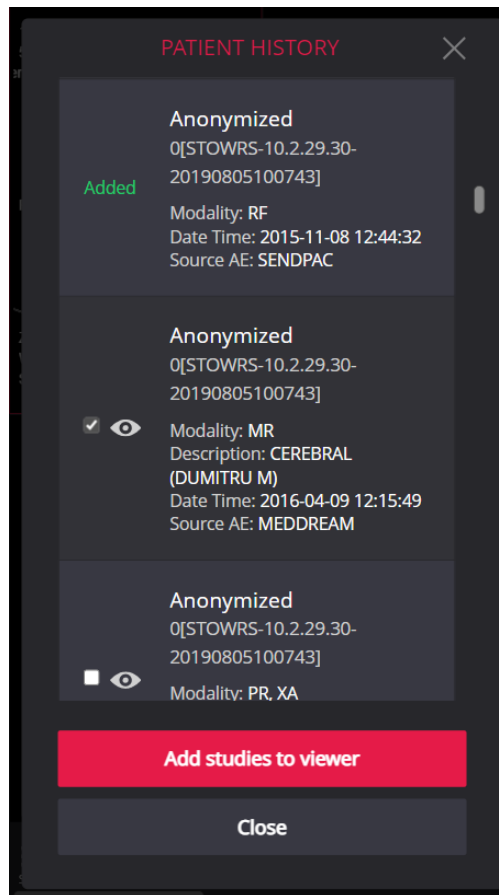



Figure 386. Patient studies list in mobile mode

You can scroll the list and open the patient studies for viewing:

- To open one study, press on the eye icon  at the left of the study description;
- To open multiple studies at once, press and mark the tick-box next to the studies description and press the **Add studies to viewer** button, when all the required studies are marked;
- All the studies, that are already opened in Viewer, are highlighted as **Added** and haven't controls for opening.



Manipulating images in MedDream Mobile mode





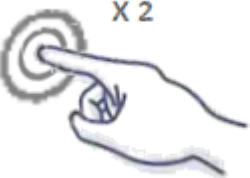

The section describes the specifics of using the image manipulation tools with touch screens. See detail description of particular tool in the following sections:



- "Tools for image manipulation and analysis" section describes tools: Windowing, Pan, Zoom, Channels, Scroll, Magnifier, Layout, Multi image, Reset, MPR, Reference Line, Crosshair, Rotate, DICOM, and Link;
- "Tools for measuring, and annotation saving" section describes Annotations, Key Objects, Segmentation, and measure menu tools: Line, Angle, Polyline, Area, Volume, Velocity Time Integral (VTI), Ellipse, Cobb Angle, Tibial Plateau Angle, Norberg Angle, Verbal Heart Scale, Hip distraction index, Tibial tuberosity advancement, Cardiothoracic ratio, Text annotations, Region Of Interest, Spine labeling, Flexpoly, Pencil, Arrow, Flatfoot, Calibration line, Show Angles, Intensity, Delete measurements, Save Annotation;
- "Tools for study exchange" section describes Share files via DICOM Library, Forward, Export, and LiveShare tools;

- “Fusion function” section describes the fusion tool;
- “Cine mode” section describes the playing as video tool;
- “Other Viewer tools” for tools Series, Plugins, Full Screen, Theme, Preload Series, Print, and Hanging protocols;
- “ECG module” for ECD manipulation toolbar and measure tools.

The table below describes what finger actions should be used on touch screens instead of mouse actions.

Touch / Touch description	Action description
<p>One finger tap - briefly touch the screen with a finger. Corresponding the mouse left button click action.</p>	
	<p>Selecting actions from the menu, selecting the active viewieport and other selection actions.</p>
<p>One finger double tap - tap the screen quickly with your finger twice. Corresponding the mouse left button double click action.</p>	
	<p>If the layout is not 1x1, double-tap on the image temporarily viewing it on top of the layout. Repeated double tap returns to the previous layout.</p>
<p> NOTE! One finger double tap drag is not working if any of tools is activated.</p>	
<p>One finger tap and hold (may also be called long press) - touch the screen with a finger and hold down until you perform the action. Does not have a direct correspondence to a mouse action. Used only in mobile.</p>	
	<p>To open the tool's expandable menu tap and hold one finger on the menu item. One finger tap on the menu item also works.</p>
<p>One finger tap and drag - touch the screen with a finger and move finger towards required direction without losing contact. Corresponding mouse drag.</p>	

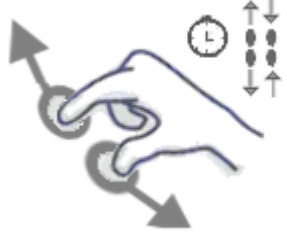
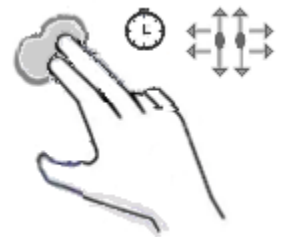
Touch / Touch description	Action description
	<p>When the someone tool is activated (is icon is highlighted, e.g. the activated Windowing tool ) one finger tap and drag perform an activated action (e.g. change WL properties). Also can be "Pan", "Zoom", "Rotate", "Measure", "Scroll" and another.</p>
<p>One finger double tap and drag - tap the screen quickly with your finger twice, do not release the finger after the second press, hold it down and drag without losing contact.</p> <p>Does not have a direct correspondence to a mouse action. Used only in mobile.</p>	
<p> Note! For double tap (both one and two fingers) to be activated, the interval between taps must be no more than 300 ms. Double tapping will only work if approximately the same area of the screen is touched. It is recommended to hold the finger for at least 300 ms after the second press, then start moving.</p>	
	<p>To change images contrast and brightness (Level and Width values) settings use one finger double tap and drag in either direction. Up-down changes the L value, side-to-side changes the W value. Moving diagonally - both values.</p>
<p> Note! Finger movements are not precise, so the position relative to the X-axis may also change slightly as you move up and down. This results in changes in both L and W values.</p>	
<p>Two fingers tap - briefly touch the screen with two fingers.</p> <p>Does not have a direct correspondence to a mouse action. Used only in mobile.</p>	
	<p>Selecting the active viewieport, in the same way as tapping with one finger.</p>
<p>Two fingers double tap drag to scroll - tap the screen quickly twice with two fingers, do not release yours fingers after the second press and drag your fingers up or down.</p>	
	<p>To scroll between series instances, use two fingers double tap and drag to scroll.</p>

Touch / Touch description	Action description
	<p>Two fingers tap and move them closer or further - touch the screen with two fingers, hold them down and then move them closer or further; when you reach the maximum or minimum distance between your fingers, you can release your fingers and repeat the action again.</p> <p>Does not have a direct correspondence to a mouse action. Used only in mobile.</p>
	<p>To increase or decrease the size of the image (commonly known as zoom), tap with two fingers and move them closer or further away.</p>
	<p>Two fingers tap and drag - tap the screen quickly twice with two fingers, do not release the fingers after the second press, hold them down, and drag an object to a different location.</p>
	<p>To move an image (commonly known as Pan), touch the screen with two fingers and drag in any direction without releasing.</p>
<p>NOTE! Pan with two finger double tap drag is not working if any of tools is activated (is icon is highlighted, e.g. the activated Windowing tool ).</p>	
	<p>Two fingers hold and rotate - touch the screen with two fingers, leaving space between the fingers, hold them down, and make a circular movement; if necessary, the action can be repeated until the object is rotated to the required angle.</p> <p>Does not have a direct correspondence to a mouse action. Used only in mobile.</p>
	<p>To rotate the image, use two fingers to hold and rotate.</p>

Setting window in mobile mode

The Settings in mobile mode are grouped by system windows and / or functions as in desktop mode.

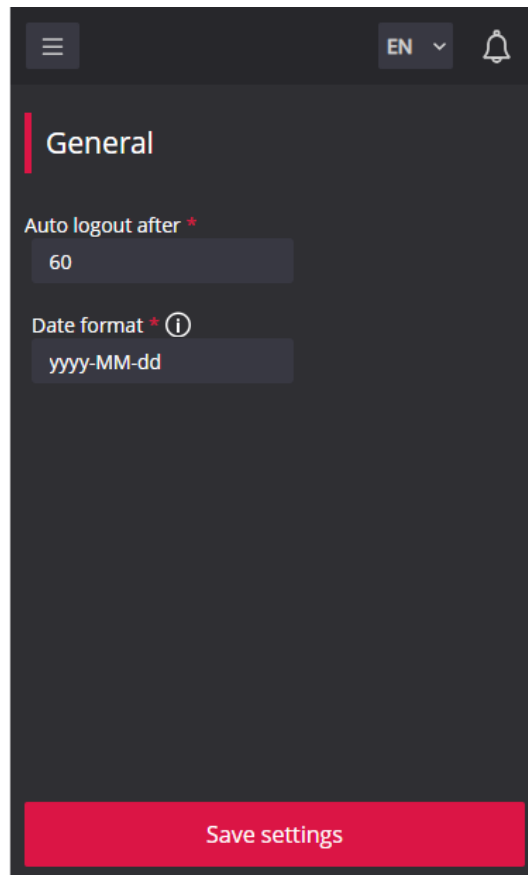



Figure 387. Settings window in mobile mode: General settings

To open the required setting group, do the following:

- Press the menu button  on the top left corner of the Settings window. The system displays the settings window menu:

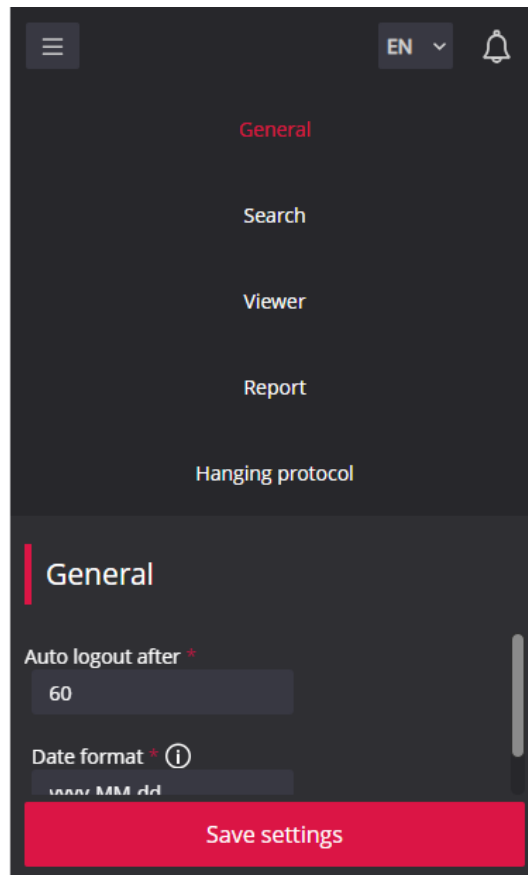

Figure 388. Settings window menu in mobile mode

- Press the menu item. The selected settings tab is opened:

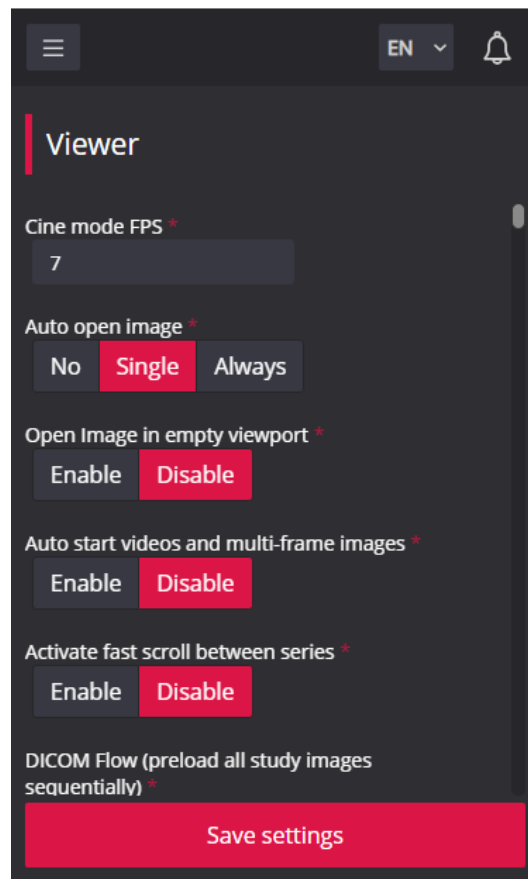

Figure 389. Settings window in mobile mode: Viewer settings

See detail settings groups and fields description in section “Settings”.

Table of Figures

Figure 1. Log in window	8
Figure 2. Language selection in a log in window.....	9
Figure 3. Notifications temporary displayed in the viewer window	9
Figure 4. Notifications window.....	10
Figure 5. Search window.....	11
Figure 6. Search criteria entry fields in search window	11
Figure 7. Quick pick list for choosing the study date interval.....	12
Figure 8. Study date interval entry fields	12
Figure 9. Pick list for choosing modality: CT is chosen	12
Figure 10. Customization of modalities pick list.....	13
Figure 11. Picking the storage.....	14
Figure 12. Picking the reporting criteria.....	14
Figure 13. Page navigation in the search results list	15
Figure 14. Marking the study.....	15
Figure 15. The other menu in Search window	15
Figure 16. Viewer window zones.....	16
Figure 17. Expanded toolbar	17
Figure 18. Study description section with additional label and highlighted comparison study date	19
Figure 19. Study description section with additional label and highlighted comparison study date	19
Figure 20. Action controls in Thumbnail	20
Figure 21. Preload progress bar.....	21
Figure 22. CT series default view without images thumbnails, and with phase filter	21
Figure 23. Image scroll bar	22
Figure 24. Comparison studies marking.....	23
Figure 25. Viewport toolbar	25
Figure 26. Quick access to additional data controls.....	28
Figure 27. Color palette selection and applying	29
Figure 28. Inverted color palette.....	29
Figure 29. Quick menu.....	30
Figure 30. Quick menu with thumbnail zone	30
Figure 31. Study selection in the search results list	31
Figure 32. Viewer window in new tab.....	31
Figure 33. New study opened in the same Viewer window	32

Figure 34. Patient studies window.....	33
Figure 35. Opening the Patient history window from the header of viewed studies	33
Figure 36. Patient history window	34
Figure 37. Searching and opening several studies from Patient history window.....	35
Figure 38. Image manipulation tools	36
Figure 39. Window button menu example.....	36
Figure 40. Managing W/L values in the histogram	38
Figure 41. Additional buttons in the histogram window	39
Figure 42. Zoom the histogram graph	39
Figure 43. Zooming the Y-axis of the histogram graph	39
Figure 44. Image alignment options in Pan menu	40
Figure 45. Align & Lock buttons on the viewport	41
Figure 46. Align & Lock. Control buttons on the opposite side of the alignment	41
Figure 47. Align & Lock. Mandatory labels to be displayed.....	41
Figure 48. Zoom button menu.....	42
Figure 49. Zoom selection.....	43
Figure 50. Color selection in Channels button menu.....	43
Figure 51. Scroll button menu	44
Figure 52. Magnification coefficient of Magnifier tool	45
Figure 53. The angiography multiframe image without (on the left), and after the mask subtraction (on the right).....	46
Figure 54. Montage window	47
Figure 55. Sync all action.....	48
Figure 56. Sync some actions	48
Figure 57. Sync CP in all viewports.....	48
Figure 58. Proportional synchronization of actions.....	49
Figure 59. 2x2 layout view with manual viewports' size adjustment.....	50
Figure 60. 2x2 Multi image menu applied in the first viewport of 1x2 layout	51
Figure 61. 2x2 Multi series menu applied in the first viewport of 1x2 layout.....	51
Figure 62. 2 panels. Enlarged inside one panel	52
Figure 63. 2 panels. Enlarged in the opposite panel	52
Figure 64. 2 panels. Enlarging two images. Side-by-side images.....	52
Figure 65. 2 panels. Enlarging two images. One image on top of another.....	53
Figure 66. 2 panels. Enlarge four images	53
Figure 67. Reset button menu.....	54
Figure 68. MPR button menu	54
Figure 69. Steps of Coronal image reconstruction from axial series of images: axial series preload and calculated coronal view	55

Figure 70. Orthogonal reconstruction from axial series of images	55
Figure 71. MPR MIST Oblique 3D indicator of the reconstruction process	56
Figure 72. The reconstruction result of MPR MIST Oblique	57
Figure 73. The Scheme of planes of transformed images.....	57
Figure 74. The thickness of the section used for image preparation in millimeters and the method of image preparation.....	58
Figure 75. Changing the slice thickness.....	58
Figure 76. Changing the image preparation method.....	58
Figure 77. Rotation of intersecting planes.....	59
Figure 78. Longitudinal displacement of intersecting planes.....	60
Figure 79. The center point of the intersecting planes	60
Figure 80. To carry the intersecting planes	61
Figure 81. Action buttons in the viewport	61
Figure 82. Show/hide axes.....	62
Figure 83. To center Axis	62
Figure 84. Action of restoring the original image.....	63
Figure 85. The list of values for the layout of transformed images	64
Figure 86. Curved plane reconstruction	65
Figure 87. Reconstructed curved plane rotation using slider or angles list	65
Figure 88. Rotation of the spatial image.....	66
Figure 89. Selection of expected Windowing levels in a spatial 3D image.....	67
Figure 90. Changing the Windowing level after selecting the default value	67
Figure 91. Additional Areas of Review	68
Figure 92. MIST axial, MIST coronal, MIST sagittal.....	69
Figure 93. Image reference line in intersecting planes.....	70
Figure 94. Not orthogonal intersecting plane view	70
Figure 95. Crosshair tool.....	71
Figure 96. Rotate button menu.....	71
Figure 97. DICOM tag window	72
Figure 98. Search according DICOM tag name in DICOM tag window.....	73
Figure 99. Expanding the SQ tags in DICOM tag window.....	73
Figure 100. Link scrolled series button menu.....	74
Figure 101. Manual link mode in Viewer with the disabled linked scrolling for one of the series.....	75
Figure 102. Measure button menu	76
Figure 103. Distance measurement	78
Figure 104. Horizontal line drawing, holding the "Alt" key pressed	79
Figure 105. Angle measurement.....	79

Figure 106. Cobb angle measurement.....	80
Figure 107. Perimeter measurement.....	80
Figure 108. Area measurement.....	81
Figure 109. Rectangle measurement.....	81
Figure 110. The first way to measure Ellipse or Rectangle.....	81
Figure 111. The second way to measure Ellipse or Rectangle.....	82
Figure 112. Replacing an ellipse with a circle. Replacing a rectangle with a square.....	82
Figure 113. Ellipse measurement.....	82
Figure 114. Ellipse editing.....	83
Figure 115. Rectangle editing.....	83
Figure 116. Volume measurement.....	84
Figure 117. Start of marking the contour of the measuring area.....	84
Figure 118. The axis of rotation.....	85
Figure 119. End of contour marking of the measuring area.....	85
Figure 120. The three-dimensional shape formation.....	86
Figure 121. The Area calculation.....	86
Figure 122. The result of volume calculation.....	87
Figure 123. The cone volume.....	87
Figure 124. The volume of a cylinder.....	87
Figure 125. The volume of an irregular figure.....	88
Figure 126. The area / volume outside the axis of rotation is rejected.....	88
Figure 127. The hollow three-dimensional shape.....	88
Figure 128. Height difference measurement.....	89
Figure 129. VTI measurement.....	89
Figure 130. Tibial Plateau Angle (TPA) measurement.....	90
Figure 131. Norberg angle circle with the center in femoral head.....	91
Figure 132. Norberg angle measurement.....	91
Figure 133. Adjusted Norberg angle measurement.....	91
Figure 134. Long axis of VHS measurement.....	92
Figure 135. Short Axis of VHS measurement.....	92
Figure 136. VHS measurement.....	93
Figure 137. S and L lines rotation.....	93
Figure 138. Hip distraction index measurement.....	94
Figure 139. TTA ruler lines displayed by the program.....	95
Figure 140. Adjusted TTA cave width measurement.....	95
Figure 141. Drawing the maximal inner thoracic diameter line of CTR measurement.....	96

Figure 142. Drawing cardiac shadow transverse line of CTR measurement.....	96
Figure 143. CTR measurement.....	97
Figure 144. Flatfoot measurement	98
Figure 145. Drawing the femoral head circle of Goniometry measurement	98
Figure 146. Drawing the knee transverse line of Goniometry measurement.....	99
Figure 147. Drawing the talus and ankle contact line of Goniometry measurement	99
Figure 148. Goniometry measurement.....	100
Figure 149. Drawing the line along the posterior femoral condyles of TT-TG Distance measurement.....	101
Figure 150. Drawing the TG line of TT-TG Distance measurement	101
Figure 151. Finding the tibial tuberosity image in TT-TG Distance measurement.....	102
Figure 152. TT-TG Distance measurement.....	102
Figure 153. Vertebra angle measurement.....	103
Figure 154. The first vertebrae labeling.....	103
Figure 155. Spine Labeling Action Definition Window	104
Figure 156. Spine Labeling action in descending order	104
Figure 157. Definition of labels to be included in the Spinal Labeling action.....	105
Figure 158. Spinal labeling pathological vertebrae T13 and L6	105
Figure 159. Enabling spinal balance measurement	106
Figure 160. Beginning of the Spinal Labeling action	106
Figure 161. The course of the Spinal Labeling action	107
Figure 162. End of the Spinal Labeling action by double-clicking	107
Figure 163. End of the Spinal Labeling action.....	108
Figure 164. Changing the position of points in the Spinal Labeling action	108
Figure 165. Changing the position of one label.....	108
Figure 166. Changing the position of labels in the Spinal Labeling action	109
Figure 167. Changing the position of entire measurement in the Spinal Labeling action.....	109
Figure 168. Setting of spinal balance measurement	109
Figure 169. Measurement of spinal balance	110
Figure 170. The result of spine balance measurement	110
Figure 171. Recalculation of spinal balance measurement when replacing C7 and S1	110
Figure 172. Marking region of interest with closed polygon tool.....	111
Figure 173. Adjusting closed polygon with Repulsor tool	112
Figure 174. The Measure Flexpoly.....	112
Figure 175. The Measure Pencil	113
Figure 176. The Measure Arrow.....	114
Figure 177. Text entry field	114

Figure 178. Time-Intensity Curve. The first ROI point	115
Figure 179. Time-Intensity Curve. With several ROIs	116
Figure 180. TIC. Changing the ROI size	116
Figure 181. TIC. The default ROI size.....	116
Figure 182. TIC. Change the ROI position	116
Figure 183. TIC. Rotate the ROI	117
Figure 184. TIC. Change from control point.....	117
Figure 185. TIC. Change color, name, delete	117
Figure 186. Intensity measurement.....	118
Figure 187. Angle measurement between intersecting lines	119
Figure 188. Ruler displayed in the viewport	120
Figure 189. Calibration line	120
Figure 190. Entering the Calibration line length	120
Figure 191. Calibration ratio result	120
Figure 192. Copy measurement button.....	121
Figure 193. Stop and Paste buttons.....	122
Figure 194. Repeating copying actions	123
Figure 195. Copy measurement values to clipboard.....	123
Figure 196. Copy measurement values to clipboard. More than one label	123
Figure 197. Save presentation state window	124
Figure 198. Annotation icon on image thumbnail	125
Figure 199. Annotation button on image	126
Figure 200. List of annotations and annotation description	126
Figure 201. View annotation.	127
Figure 202. Mark image as key object window.....	127
Figure 203. Not saved Key Object	128
Figure 204. Save study key object window	128
Figure 205. Saved Key Object	129
Figure 206. Selection of Key object filter in context menu.....	130
Figure 207. Key object with annotation	130
Figure 208. Opening a key object with annotation	131
Figure 209. Segmentation button menu	131
Figure 210. Segmentation window	132
Figure 211. Creating a new Bounding Box.....	133
Figure 212. New 2D Bounding Box segment created	134
Figure 213. New 3D Bounding Box segment created	135

Figure 214. The edit mode for the Bounding Box.....	135
Figure 215. The Bounding Box moved to the center of the femoral head	136
Figure 216. The Bounding Box is resized to fit the femoral head.....	136
Figure 217. The Bounding Box rotated to better match the femoral head.....	137
Figure 218. The Bounding Box rotated to better match the femoral head.....	137
Figure 219. A Smart Paint segmentation	138
Figure 220. The Smart Paint 3D mode.....	139
Figure 221. The Smart Paint 2D mode.....	139
Figure 222. Draw the contour of Free Draw	140
Figure 223. Removing the inner area.....	141
Figure 224. The area removed from the side of segment	141
Figure 225. The area added to a side of the Free Draw.....	141
Figure 226. Adding a new Free Draw region.....	142
Figure 227. Removal of a section of a Free Draw segment.....	142
Figure 228. Preparing images for interpolation	143
Figure 229. Unconfirmed interpolation result	144
Figure 230. Rejection of the interpolation result.....	144
Figure 231. Accept of the interpolation result.....	145
Figure 232. The Smart Paint segmentation cursor.....	145
Figure 233. The Paintbrush.....	146
Figure 234. Removing an area with the Paintbrush tool.....	146
Figure 235. The Paintbrush with reference pixel.....	147
Figure 236. The Fill color	148
Figure 237. Removing an area with the Fill color	148
Figure 238. The Fill Paintbrush	149
Figure 239. The Smooth Edges	149
Figure 240. Parameters of tools.....	150
Figure 241. Radius.....	151
Figure 242. Changing radius with assigned shortcut.....	151
Figure 243. Sensitivity.....	152
Figure 244. Transparency	152
Figure 245. The outline of the segmented area	153
Figure 246. Smart Paint results in three orthogonal views	154
Figure 247. Common actions of segmentations.....	155
Figure 248. Actions forbidden in save progress	155
Figure 249. Modifying the color of a segmentation.....	156

Figure 250. To change the name of a segmentation.....	156
Figure 251. Show/hide all segments	157
Figure 252. Navigation to the middle of the segment.....	157
Figure 253. Highlighting a segment icon in the thumbnail bar.....	158
Figure 254. Measurements information.....	158
Figure 255. Measurements information for each image.....	159
Figure 256. The information export for one segment	159
Figure 257. The information exported for all segments	160
Figure 258. Left ilium segmentation duplicated and created Bounding Box 3 copy moved.....	162
Figure 259. Delete the segment	162
Figure 260. The groups by study.....	163
Figure 261. The groups by series.....	163
Figure 262. Minimize and resize Window.....	164
Figure 263. Shortcuts.....	165
Figure 264. Message attempting to close a window without saving	165
Figure 265. Selecting scope for sharing via DICOM Library	166
Figure 266. Share via DICOM Library dialog window.....	167
Figure 267. Recent Export Jobs option in Export menu	168
Figure 268. LiveShare host window when live sharing not started.....	169
Figure 269. LiveShare host window with liveShare session running and two guests connected	169
Figure 270. Guest Viewer window.....	170
Figure 271. Fusion window	171
Figure 272. Fusion series.....	172
Figure 273. The toolbar of the fusion series.....	172
Figure 274. Changing color range of the fusion top series	172
Figure 275. Fusion ratio bar in fusion series toolbar	173
Figure 276. Pan tool in fusion series toolbar	173
Figure 277. Pan tool in fusion series toolbar	173
Figure 278. Zoom tool in fusion series toolbar	173
Figure 279. Rotate tool in fusion series toolbar	173
Figure 280. Upper layer Manual Adjustment tool in fusion series toolbar	174
Figure 281. Standard uptake value measurement in fusion series.....	174
Figure 282. Reset button in fusion series toolbar	174
Figure 283. Close button in fusion series toolbar	174
Figure 284. Preload of series data for cine mode.....	175
Figure 285. Cine mode movie playing.....	175

Figure 286. Study window.....	176
Figure 287. Series preload process progress bar	178
Figure 288. Print options	179
Figure 289. Hanging protocol options window	179
Figure 290. Hanging protocol menu options	180
Figure 291. Creation of a virtual series. Series selection dialogue.....	183
Figure 292. Creation of a virtual series. Horizontal slider.....	183
Figure 293. Presenter tool.....	184
Figure 294. ECG viewer window	185
Figure 295. ECG measure tools.....	186
Figure 296. Using Measurement (mV, s) tool.....	186
Figure 297. Using QT points tool.....	187
Figure 298. Using HR measurement tool	187
Figure 299. Using QRS Axis tool.....	188
Figure 300. ECG viewport toolbar	188
Figure 301. SR viewer window.....	189
Figure 302. PDF display.....	190
Figure 303. Video player.....	191
Figure 304. Viewing multi-frame image.....	191
Figure 305. Image with overlay layer displayed	192
Figure 306. Chrome properties	193
Figure 307. Chrome web store.....	193
Figure 308. Filtering MedDream extension	194
Figure 309. Accessing the options of the added MedDream extension	194
Figure 310. MedDream extension options window with 3 monitors.....	195
Figure 311. Display 1 monitor selected.....	196
Figure 312. Configuring window management.....	197
Figure 313. MedDream DICOM Viewer on 2 displays.....	197
Figure 314. MedDream DICOM Viewer on 3 displays.....	198
Figure 315. Modal window resizing.....	198
Figure 316. Changing the modal window position.....	199
Figure 317. Resizing the non-modal window	199
Figure 318. Changing the non-modal window position.....	199
Figure 319. Minimizing the non-modal window	200
Figure 320. Forward window	201
Figure 321. Searching for the forward destination.....	201

Figure 322. Information about initiated forward process	202
Figure 323. Forward processes list in Recently forwarded window	202
Figure 324. Export window	203
Figure 325. ISO volumes list and saving buttons	206
Figure 326. Notification about finished export	206
Figure 327. Recent Export Jobs window	206
Figure 328. Report window in edit mode is opened after clicking the Create report icon	208
Figure 329. Report content successfully saved	210
Figure 330. Report attachments successfully added	211
Figure 331. Selecting the report version	211
Figure 332. Viewing historical report version	212
Figure 333. Report window in view mode	213
Figure 334. Templates section of the Report window	213
Figure 335. Report template window	214
Figure 336. Information window	216
Figure 337. EULA window	218
Figure 338. Shortcuts window	218
Figure 339. Create keyboard shortcut window with entered shortcut and duplicated shortcut notification	219
Figure 340. Clear cache window	220
Figure 341. Cache clearing scope selection	220
Figure 342. Demo version notification	222
Figure 343. Registration window, if EULA is not read	222
Figure 344. Registration window – registration activated	223
Figure 345. Settings window	224
Figure 346. Settings window: general settings	225
Figure 347. Settings window: search setting	225
Figure 348. Settings window: general Viewer window settings	226
Figure 349. Settings window: modalities selection for Activate fast scroll between series setting	227
Figure 350. Settings window: Viewer thumbnails and layout window settings	228
Figure 351. Settings window: measurements' settings	229
Figure 352. Setting window: Info Label properties in Viewer tab	230
Figure 353. Info Label entry field	230
Figure 354. Showing Info Label on image	231
Figure 355. Setting window: Highlight comparison studies settings	232
Figure 356. Setting window: Custom study label properties	232
Figure 357. Settings window. Presenter settings	233

Figure 358. Setting window: Toolbar properties in Viewer tab	233
Figure 359. Changing the tool's position in toolbar	234
Figure 360. Selecting the tool's showing mode	234
Figure 361. Quick menu: measurement in the first menu level by default.....	235
Figure 362. Quick menu: Measure tool included in quick menu and measure option moved to the second menu level.....	235
Figure 363. Custom windowing options: default values	235
Figure 364. Custom Windowing creation window.....	236
Figure 365. Custom windowing in the drop-down Windowing menu.....	237
Figure 366. Settings window: report settings	237
Figure 367. Hanging protocol settings.....	238
Figure 368. Modality filter for metadata fetching	238
Figure 369. Create hanging protocol group window.....	239
Figure 370. Hanging protocol condition's entry fields.....	240
Figure 371. Create protocol window.....	241
Figure 372. Entering View settings in hanging protocol	242
Figure 373. Hanging protocols list.....	242
Figure 374. Search criteria window in mobile mode.....	245
Figure 375. Search results window in mobile mode	246
Figure 376. Page navigation in the search results in mobile mode	247
Figure 377. Viewer window zones in mobile mode	248
Figure 378. Toolbar's scrollbar in mobile mode.....	248
Figure 379. Tool's menu in Viewer window in mobile mode.....	249
Figure 380. Study description area in Search results window in mobile mode.....	250
Figure 381. Selecting the study image in mobile mode.....	251
Figure 382. Viewing selected image in mobile mode	251
Figure 383. 2x1 Screen layout with active bottom viewport in Viewer window mobile mode	252
Figure 384. New study added at the top of the studies list of the viewer window.....	253
Figure 385. Multiple images opened in mobile mode	253
Figure 386. Patient studies list in mobile mode	254
Figure 387. Settings window in mobile mode: General settings.....	258
Figure 388. Settings window menu in mobile mode	259
Figure 389. Settings window in mobile mode: Viewer settings.....	260

Index

4	
4D Tools	182
A	
About	216
Angle	79
Annotations	124
Area	80
Arrow	113
Axial, Coronal, Sagittal	54
B	
Bounding Box	132
C	
Calibration line	120
Cardiothoracic ratio (CTR)	95
Channels	43
Cine mode	175
Clear cache	220
Closed polygon	111
Cob Angle	79
Color palette for monochrome images	28
Construct 4D series	182
Continuous measurement	118
Copy and paste ellipse	123
Copy and paste measurement	121
Copy measurement values to clipboard	123
Copy original image to the clipboard	27
Copy viewport content	26
Crosshair	70
Curved Planar Reconstruction (CPR)	64
Custom study label properties	232
D	
Delete all measurements	120
Delete selected measurement	121
DICOM	72
Digital Subtraction	45
Displaying notifications	9
E	
ECG module	185
Ellipse	81
Entering the Hanging protocol condition	239
Export	168
Export and Forward	200

Export window	203
F	
Flatfoot	97, 98, 100
Flexpoly.....	112
Forward.....	167
Forward window.....	200
Full Screen	177
Fusion function	171
G	
General information about the MedDream product see in MedDream USER MANUAL document	7
General settings.....	225
H	
Hanging protocol settings.....	238
Hanging protocols.....	179
Heart rate (HR) measurement	187
Height Difference.....	88
Help.....	218
Highlight comparison studies.....	231
Hip distraction index, Hip DI	93
Histogram	38
I	
Info Labels.....	181
Info Labels on image	230
Installation requirements and verification see in MedDream USER MANUAL document	7
Intensity.....	118
IT security measures see in MedDream USER MANUAL document.....	7
K	
Key object with annotation.....	130
Key Objects	127
L	
Layout	49
License Agreement	217
License registration.....	222
Line	78
Link scrolled series.....	73
List of applicable standards see in MedDream USER MANUAL document	7
LiveShare.....	168
Log Off	221
Logging on to MedDream	8
M	
Magnifier	44
Mandatory visible labels for Align&Lock.....	232
Manipulating fusion series.....	172
Manipulating images in MedDream Mobile mode	254

Maximize viewport	50, 190
Measurement (mV,s)	186
Measurements' colors and thickness.....	229
Measuring images.....	76
MedDream DICOM Viewer	16
MedDream DICOM Viewer Chrome browser extension for multi-monitors	193
MedDream Mobile mode	244
Minimum hardware requirements for client-side MedDream viewing functions	7
MIST Axial, MIST Coronal, MIST Sagittal	68
MIST Oblique	56
Montage	46
MPR	54
Multi image.....	50
Multi series	50
Multi-frame view	191
 N	
Norberg Angle.....	90
 O	
Opening studies	31
Opening studies in MedDream Mobile mode.....	250
Orthogonal.....	55
Overlay layer	192
 P	
Pan	40
Patient history	33
Patient studies list in mobile mode.....	253
Patient studies window	32
PDF view	190
Pencil	113
Plugins.....	177
Polyline	80
Preload Series	20, 178
Preload Study.....	20, 44
Presenter settings	232
Presenter tool	76, 184
Print	178
 Q	
QRS measurement	187
QT points (PR, QT, QTs).....	186
Quick access to additional data	27
Quick menu.....	29
Quick save KO, PR	124, 129
 R	
Recent Export Jobs window	206
Rectangle	81
Reference Line	69
Region Of Interest.....	111
Report	181

Report module	208
Report settings.....	237
Repulsor	111
Reset	53
Rotate	71
Ruler	119
Ruler applicable for modalities	229

S

Save Annotation	121
Scroll	44
Search of studies.....	10
Search of studies in mobile mode.....	244
Search window settings	225
Segmentation.....	131
Series	176
Settings	220
Settings	224
Settings window in mobile mode	257
Share files via DICOM Library.....	166
Shortcuts.....	218
Show 4D slider bar	183
Show Angles.....	119
Sync actions	47
System menu functions	216
System tools in the Viewer window.....	18
Size and position of window	198
Spine balance measurement	109
Spine Labeling.....	103
Split layout.....	52
SR view.....	189

T

Table of Contents.....	3
Table of Figures.....	261
Text annotations.....	114
Theme.....	177
Thumbnails	177
Thumbnails bar in the Viewer window	18
Thumbnails settings.....	228
Tibial Plateau Angle	89
Tibial tuberosity advancement (TTA).....	94
Time-Intensity Curve.....	115
Toolbar in the Viewer window.....	17
Toolbar Properties	233

V

Velocity Time Integral (VTI).....	89
Verbal Heart Scale	91
Vertebra angle	103
Video view	190
View zone in the Viewer window	22
Viewer window	16
Viewer window in mobile mode	247
Viewer window settings.....	226

Viewport controls	24
Viewport toolbar.....	24
Volume.....	83

W

Warnings regarding residual risks see in MedDream USER MANUAL document	7
Windowing.....	36
Windowing settings	235

Z

Zoom.....	42
-----------	----



MedDream is manufactured by Softneta UAB.
Medical device class: Regulation (EU) 2017/745
Class IIb medical device
FDA cleared K222320
ID of the notified body: 0197
Document version 1.0
Date of issue: 2023-12-15
Language: EN
Softneta UAB
K.Barsausko str. 59B
LT-51423 Kaunas, Lithuania

CE 0197
Class IIb certified

FDA K222320
CLEARED 510(k)